

*NATIONAL GEODETIC SURVEY
USER GUIDELINES
FOR SINGLE BASE
REAL TIME GNSS POSITIONING*



v. 3.1.1 December 2009

William Henning, lead author

Acknowledgements

The writing of these guidelines has involved a myriad of resources. Besides the author's personal experience with different manufacturers' hardware and software for classical real-time (RT) Global Navigation Satellite Systems (GNSS) positioning for over fifteen years, the internet was the primary source for definitive documents and discussions. Additionally, many agencies have published single-base guidelines of some sort over the years to aid their users in the application of the technology and to provide consistency with the results. The following are gratefully acknowledged as sources for research and information:

- National Geodetic Survey (NGS)– publications and internal documents
- NGS – Corbin, VA. Laboratory and Training Center
- Major GNSS hardware/software manufacturers' sites
- National Oceanic and Atmospheric Administration (NOAA) Space Weather Prediction Center
- American Association for Geodetic Surveying (AAGS) Government Programs Committee
- Bureau of Land Management
- U.S. Forest Service
- Institute of Navigation (ION) proceedings
- California Department of Transportation
- Florida Department of Transportation
- Michigan Department of Transportation
- New York State Department of Transportation
- North Carolina Department of Transportation
- Vermont Agency of Transportation
- Institution of Surveyors Australia - The Australian Surveyor technical papers
- British Columbia, Canada, Guidelines for RTK
- New Zealand technical report on GPS guidelines
- Intergovernmental Committee on Surveying and Mapping, Australia– Standards & Practices for Control Surveys
- University of New South Wales, Sydney Australia - Engineering
- University of Calgary – Geomatics
- Bundesamt für Kartographie und Geodäsie (BKG) – Germany

The author wishes to especially recognize two individuals who have brought tireless encouragement, education and support to all they touch. Alan Dragoo introduced the author as a much younger man to GPS many years ago and remains a readily accessible source of practical knowledge for so many. Dave Doyle has taken geodetic knowledge from the text books and made it understandable and practical to everyone for decades. Both are what it means to be a true professional and to give back of themselves to our rich geospatial heritage.

Table of Contents

Acknowledgements.....	<i>i</i>
Table of Contents.....	<i>ii</i>
Notation and Acronyms.....	<i>iii</i>
I. Introduction.....	1
II. Equipment.....	4
III. RT GNSS Positioning.....	11
IV. Before Beginning Work.....	18
V. Field Procedures.....	29
VI. Further Work in the Office.....	48
VII. Contrast to Real-time Networks (RTN).....	51
VIII. Best Methods Summary.....	53
IX. Classical Real-time Positioning Glossary.....	58
References.....	92
Appendix A – Vermont Case Study.....	94
Appendix B – Differencing & Ambiguity Resolution.....	109
Appendix C – Adjusting the Circular Vial.....	125
Appendix D – On Determining Survey Project Coordinates and Heights.....	126
Appendix E – Low Distortion Local Projections.....	131

Notations and Acronyms

φ	Cycles of Carrier Wave
Δ	Difference
c	Speed of Light in a vacuum (299,792.458 km/sec)
f	Frequency
σ	Sigma, one standard deviation in a normal distribution
λ	Wave Length
AR	Ambiguity Resolution
ARP	Antenna Reference Point
C/A code	Coarse Acquisition or Clear Acquisition code
CDMA	Code Division Multiple Access
CORS	Continuously Operating Reference Station(s)
DD	Double Difference
DoD	Department of Defense
DGPS	Differential GPS
ECEF	Earth Centered, Earth Fixed (Coordinates)
FDMA	Frequency Division Multiple Access
G1 to G5	Geomagnetic Storm categories
GDOP	Geometric Dilution of Precision
GIS	Geographic Information System
GLONASS	Global'naya Navigatsionnaya Sputnikovaya Sistema (Global Orbiting Navigation Satellite System-Russian)
GNSS	Global Navigation Satellite System (worldwide)
GPS	NAVSTAR Global Positioning System
GPRS	General Packet Radio Service
GRS 80	Geodetic Reference System 1980
GSM	Global System for Mobile Communications
HDOP	Horizontal Dilution of Precision
IP	Internet Protocol
ITRF	International Terrestrial Reference Frame
L_1	GPS L band carrier wave at 1575.42 MHz
L_2	GPS L band carrier wave at 1227.60 MHz
L_5	GPS L band carrier wave at 1176.45 MHz

Notations and Acronyms (Continued)

L_n	Narrow Lane frequency combination ($L_1 + L_2$)
L_w	Wide Lane frequency combination ($L_1 - L_2$)
MHz	Megahertz (1 million cycles/second)
NAD 83	North American Datum 1983
NAVD 88	North American Vertical Datum 1988
NGS	National Geodetic Survey
NMEA	National Marine Electronics Association
NOAA	National Oceanic and Atmospheric Administration
NSRS	National Spatial Reference System
P code	Precise Code
PCV	Phase Center Variation
PDOP	Position Dilution of Precision
PPM	Part(s) Per Million
PRN	Pseudorandom Noise (or Number)
PZ 90	Parametry Zemli 1990 (Parameters of the Earth 1990 -Russian)
R1 to R5	Radio Blackout Event categories
RDOP	Relative Dilution of Precision
RT	Real-Time Positioning
RTCM	Radio Technical Commission for Maritime Services
RTCM SC-104	RTCM Special Committee 104 (differential positioning)
RTK	Real-Time Kinematic
RTN	Real-Time Network(s)
RMS	Root Mean Square
S1 to S5	Solar Radiation Event categories
S/A	Selective Availability
SIM	Subscriber Identity Module
SPC	State Plane Coordinate(s)
SVN	Space Vehicle Number
SWPC	Space Weather Prediction Center
TCP	Transmission Control Protocol
TDOP	Time Dilution of Precision

Notations and Acronyms (Concluded)

TTF	Time To First Fix
UERE	User Equivalent Range Error
UHF	Ultra High Frequency
UTM	Universal Transverse Mercator
VDOP	Vertical Dilution of Precision
VHF	Very High Frequency
WGS 84	World Geodetic System 1984

Version History

Versions 1.0 to 1.9 = original with internal draft editing to April 2008

Versions 2.0.0 to 2.4.0 = reflects public comments to August 2009

Versions 3.0.0 to _____ = reflects AAGS Government Programs Committee comments, author's additions and further public comment - current

I. Introduction

These user guidelines are intended to provide a practical method to obtain consistent, accurate three-dimensional positions using classical, single-base real-time (RT) techniques (see Chapter V.). However, in addition to these best methods, and due to the plethora of variables associated with RT positioning, this document is meant to be a source for pertinent background information that the competent RT user should digest and keep in mind when performing high accuracy positioning. Due to the rapidly changing environment of Global Navigation Satellite System (GNSS) positioning, it is understood that this documentation will be dynamic and would be best served to remain in digital form. Improvements to GNSS hardware and software, increased wireless communication capabilities, new signals and additional satellite constellations in production or planned will yield significantly increased capabilities in easier, faster and more accurate data for the RT positioning world in the near future. These guidelines are not meant to exclude other accepted practices that users have found to produce accurate results, but will augment the basic knowledge base to increase confidence in RT positioning.

Classical (single-base) Real-Time Kinematic (RTK) positioning or “RT” positioning as commonly shortened, is a powerful application employing GNSS technology to produce and collect three-dimensional (3-D) positions relative to a fixed (stationary) base station with expected relative accuracies in each coordinate component on the order of a centimeter, using minimal epochs of data collection. Baseline vectors are produced from the antenna phase center (APC) of a stationary base receiver to the APC of the rover antenna using the Earth-Centered, Earth-Fixed (ECEF) X,Y,Z Cartesian coordinates of the World Geodetic System 1984 (WGS 84) datum, which is the reference system in which the Department of Defense (DoD) Navstar Global Positioning System (GPS) system broadcast orbits are realized (differential X,Y,Z vectors in other reference frames would be possible if different orbits were used). Some current technology may also incorporate the Russian Federation Global'naya Navigatsionnaya Sputnikovaya Sistema (GLONASS) constellation into the computations, whose orbits are defined in the Parametry Zemli 1990 (Parameters of the Earth 1990- PZ 90.02) datum. The coordinates of the point of interest at the rover position are then obtained by adding the vector (as a difference in Cartesian coordinates) to the station coordinates of the base receiver, and applying the antenna height

above the base station mark and also the height of the rover pole. Usually, the antenna reference point (ARP) is used as a fixed vertical reference. Phase center variation models, which include a vertical offset constant, are typically applied in the RT firmware to position the electrical phase center of the antenna, which varies by satellite elevation and azimuth.

Because of the variables involved with RT however, the reliability of the positions obtained are much harder to verify than static or rapid static GNSS positioning. The myriad of variables involved require good knowledge and attention to detail from the field operator. Therefore, experience, science and art are all part of using RT to its best advantage.

RT positioning of important data points can not be done reliably without some form of redundancy. As has been shown in the NOAA Manual NOS NGS-58 document “*GPS Derived Ellipsoid Heights*” (Zilkoski, et. al., 1997), and NOAA Manual NOS NGS-59 document “*GPS Derived Orthometric Heights*” (Zilkoski, et. al., 2005), GNSS positions can be expected to be more accurate when one position that is obtained at a particular time of day is averaged with a redundant position obtained at a time staggered by 3 or 4 hours (and thus with different satellite geometry). The different satellite geometry commonly produces different results at the staggered times. The position, all other conditions being equal, can be accurately obtained by simple averaging of the two (or more) positions thus obtained. Redundant observations are covered in the Accuracy Classes of the Field Procedures section, where most of the RT Check List items, found below, are also discussed.

An appreciation of the many variables involved with RT positioning will result in better planning and field procedures. In the coming years when a modernized GPS constellation and a more robust GLONASS constellation will be joined by Compass/Beidou (China), Galileo (European Union) and possibly other GNSS, there could be in excess of 115 satellites accessible. Accurate, repeatable positions could become much easier at that time.

NOTES: The term “user” in this document refers to a person who uses RT GNSS surveying techniques and/or analyzes RT GNSS data to determine three dimensional position coordinates and metadata using RT methods.

Outside of the Summary sections, important concepts or procedures are designated with an asterisk, italicized, bolded and underlined, e.g., * **Redundancy is critical for important point positions using RT.**

Typical RT Checklist

Look for these terms and concepts in the guidelines. Knowledge of these is necessary for expertise at the rover:

- DOP varieties
- Multipath
- Baseline RMS
- Number of satellites
- Elevation mask (or cut-off angle)
- Base accuracy- datum level, local level
- Base security
- Redundancy, redundancy, redundancy
- PPM – iono, tropo models, orbit errors
- Space weather- ‘G’, ‘S’, ‘R’ levels
- Geoid quality
- Constraining passive monuments
- Bubble adjustment
- Latency, update rate
- Fixed and float solutions

II. Equipment

A typical current-configured, user operated field RT set up might use the following equipment:

BASE:

1 - dual frequency GPS + GLONASS GNSS base receiver

1- dual frequency GPS + GLONASS GNSS high quality antenna capable of multipath rejection characteristics traditionally found in ground plane and/or choke ring antennas

1- GNSS antenna cable

1- fixed height tripod, weights for the legs on long occupations

1- lead-acid battery with power lead to receiver. (Note: typical power input level on GNSS receivers is in the range of 10.5 volts – 28 volts. Users frequently use a 12 volt lawn tractor battery to keep the carrying weight down.)

Data transmission can be done by one of the following:

a) Broadcast Radio

UHF (0.3 GHz – 3.0 GHz) = 25 watt- 35 watt base radio, Federal Communications Commission (FCC) licensed (required with severe non-compliance penalties) two to four channels (ten or more channels recommended), lead acid battery, power cable, antenna mast, antenna tripod or mount for base tripod, data cable. Range is typically 5 km - 8 km (3 miles -5 miles) in non-rural areas.

*** Regardless of the type of external battery used, it should supply at least 12 volts and should be fully charged. An underpowered battery can severely limit communication range.**

Note: A full-size whip antenna option will enhance communications. It can produce a higher signal to noise ratio and therefore, a longer usable communication range. Also, to greatly extend range in linear surveys (highways, transmission lines, etc.), a directional antenna for the broadcast radio should be considered.

***The base broadcast radio antenna should be raised to the maximum height possible.**

Studies have shown that an increase in antenna height from 5' to 20' will increase the broadcast range from 5 miles to 11 miles. The study shows a doubling in antenna height will increase the range by 40%. However, any height over 25' should use a low-loss cable. OR

b) TCP/IP data connection

CDMA (SIM/Cell/CF card) = wireless data modem, card or phone with static IP address, battery pack and cable, data cable from receiver or Bluetooth, whip antenna. With the availability of cell coverage, the range is limited only by the ability to resolve the ambiguities.

ROVER:

1-dual frequency GPS + GLONASS GNSS integrated receiver/antenna, internal batteries

1- carbon fiber rover pole (two sections fixed height), circular level vial

Note: the condition of the rover pole should be straight and not warped or bent in any manner.

1 – rover pole bipod or tripod with quick release legs

1- data collector, internal battery and pole mount bracket

1- datalink between Receiver and Data Collector, encompassing:

a) Cable

OR

b) Bluetooth wireless connection

Data Reception by one of the following:

a) Internal UHF radio (receive only, paired to base frequency) with whip antenna

OR

b) CDMA/SIM/Cell/CF card = wireless data modem with static IP address, battery pack and cable, data cable from receiver or Bluetooth, whip antenna.

Note: Spread spectrum radios can be used for small project areas. These do not require a FCC license but the range is relatively limited – in many cases to only line of sight. Various peripherals, such as laser range finders, inclinometers, electronic compasses, etc. are also available and may prove useful for various applications.

A Note on Single Frequency RT: Single frequency GPS RT is possible. While this application would mean reduced hardware expense, it also would mean longer initialization times, no on-the-fly initialization, less robustness, require shorter baselines and would preclude frequency combinations (such as the L₃, iono-free combination). Thus, L₁ RT positioning is not a preferred solution, and will not be further addressed as a unique application in this document. The general principles and best methods for RT field work still apply, however, and should be applied for L₁ work as well.



Diagram II-1. The base station should use a ground plane, choke ring, or a current high quality, geodetic, multipath rejecting antenna while the rover typically operates with a smaller antenna (usually integrated with the rover receiver) for ease of use.

*** Adjust the base and rover circular level vial before every campaign (See Appendix C).**

** As a good practice or if the circular level vial is not adjusted, it is still possible to eliminate the possible plumbing error by taking two locations on a point with the rover pole rotated 180° between each location.*

TYPICAL BASE UHF RADIO RT SET UPS

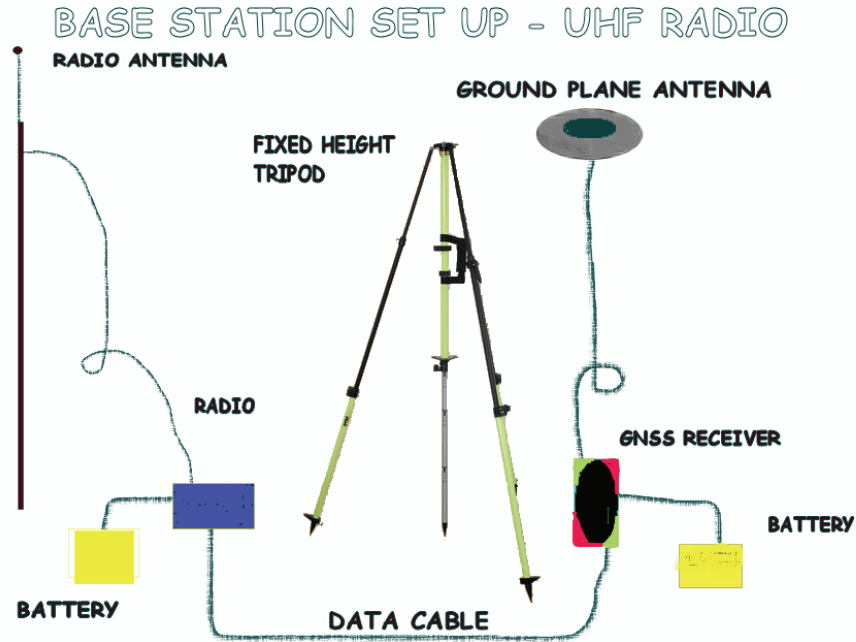

Diagram II-2 – Typical UHF Radio Base Set Up. The radio antenna should be elevated to the greatest extent possible to facilitate broadcast range.

ROVER SET UP - INTERNAL RADIO

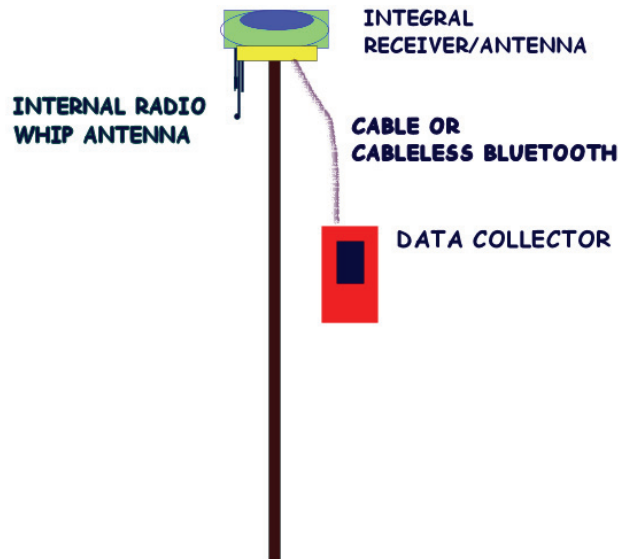

Diagram II-3 – Typical UHF Radio Rover Set Up (Receive-Only)

Typical Code Division Multiple Access (CDMA) data modems (see **Diagrams II-4 & 5**) and flash media modems (see **Diagram II-6**) require the user to subscribe to a wireless phone service, but this allows for use of the wireless service providers' cell towers for Internet connectivity to send and receive data over much longer distances than with UHF broadcasts. These would replace the UHF radio configuration for the base and rover shown in Diagrams II-2 & II-3. Data services are available by monthly subscriptions through several carriers, varying by geographical region. The user must contact the carrier to set up a data service. Typically, rates vary by data usage rather than by time. Data are sent by the base via a TCP/IP address to the rover, that then performs the correction and difference calculations and displays the results with no loss of usable latency— typically fewer than 2 or 3 seconds total to position display (see this topic in Chapter V.). These systems enable virtually unlimited range from the base station. However, in a scenario where only one base station is used, the ability to resolve ambiguities at a common epoch and the part per million errors limit accuracy range in most cases. The fact that atmospheric conditions can vary from base position to rover position, particularly at extended ranges, and the fact that the rover uses the conditions broadcast from the base, cause the range and phase corrections to be improperly applied, contributing to positional error. CDMA modems can be used effectively at extended ranges in RT networks (RTN) where the atmospheric and orbital errors are interpolated to the site of the rover. Cell phones and stand alone Subscriber Identity Module (SIM) cards (see **Diagram II-7**) in Global System for Mobile Communication (GSM) networks use similar methods as CDMA data modems to send data. Many current GNSS receivers have integrated communication modules.

Rather than communicating with a *dynamic* address as is the case in many internet scenarios, **static IP** addresses provide a reliable connection and are the recommended communication link configuration. Static addresses are linked with the same address every time the data modems connect and are not in use when there is no connection. However, there is a cost premium for this service. Contact the wireless service provider for the actual rates.



Diagram II-4 – CDMA Modem Front Panel (Courtesy of AirLink Comm.)



- Tx (transmit) and Rx (receive) - Lights will flash as data is transferred to and from the Raven on the remote network.
- RSSI(signal level) - Light shows the strength of the signal and may be nearly solid (strong signal) or flashing (weaker signal). A slow flash indicates a very weak signal.
- Reg (registration) - Indicates the Raven has acquired an IP from Verizon.
- Chan (channel) - Indicates the modem has acquired a network channel.
- Link - Indicates a successful connection to the cellular network.
- Pwr (power) - Indicates the power adapter is connected and there is power getting to the modem.

Note the data transmission and signal strength lights

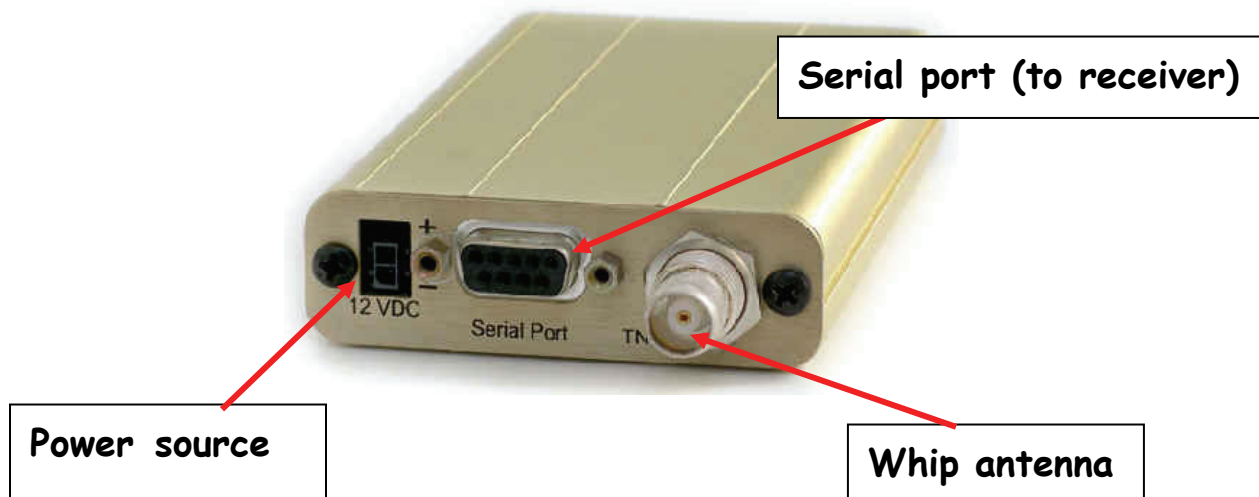

Diagram II-5 – CDMA Data Modem Back Panel



Diagram II-6 – Examples of Compact Flash Modems

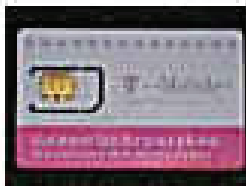

Diagram II-7 – Examples of SIM Cards used in GSM/GPRS format Data Service

III. RT GNSS Positioning

RT positioning relies on differences in carrier phase cycles, in each available frequency to each satellite, between the base station and rover at common epochs of time. Two L-band frequencies, L_1 and L_2 , are currently available to GPS users at this writing with a third frequency, L_5 , being added in the Block II-F and Block III satellites. A summary of the code and carrier phases is given in **Table III-1**. The two frequencies (L_1 and L_2) are derived from a fundamental frequency of 10.23 MHz, so that:

$$L_1 = 1575.42 \text{ MHz} = 154 \times 10.23 \text{ MHz}$$

And

$$L_2 = 1227.6 \text{ MHz} = 120 \times 10.23 \text{ MHz}$$

The wavelengths of the carriers are:

$$\lambda_1 = 19.03 \text{ cm}$$

$$\lambda_2 = 24.42 \text{ cm}$$

FREQUENCY LABEL	FREQUENCY	CONTENTS
L_1	1575.42 MHz	COARSE ACQUISITION (C/A) CODE, PRECISE CODE [P(Y)], NAVIGATION MESSAGE
L_2	1227.60 MHz	PRECISE CODE [P(Y)], L_2 C CIVIL CODE ON BLOCK II-M AND NEWER
L_5	1176.45 MHz	CIVILIAN SAFETY OF LIFE (SoL-PROTECTED AERONAUTICAL, NO INTERFERENCE), BLOCK II-F AND BLOCK III

TABLE III-1- Civilian GPS L band frequencies. L_5 is future in Block II-F and Block III Satellites.

In classical single-base RT positioning, most of the error budget (see **Table III-2**) is addressed by simply assuming that atmospheric conditions are identical at the base and rover. The rest are usually eliminated using double differencing techniques. The User Equivalent Range Error (UERE) is the total of the uncorrected errors expected with normal conditions. See Appendix B for graphics and the GPS observable equations describing the differencing process.

ERROR	VALUE
Ionosphere	4.0 METERS
Ephemeris	2.1 METERS
Clock	2.1 METERS
Troposphere	0.7 METERS
Receiver	0.5 METERS
Multipath	1.0 METERS
TOTAL	10.4 METERS
UNCORRELATED ERROR	5.15 m (square root of sum of errors squared)

TABLE III-2. The GPS Error Budget. Errors are as given for the GNSS antenna zero zenith angle. Clock and hardware errors are eliminated with differencing, while some modeling can be done for the Ionospheric and Tropospheric errors. Generally, the conditions are considered to cancel as they are relative to both base and rover receivers. Note: 1 nanosecond of time error translates to 30 cm in range error

GLONASS can augment the functionality of GPS. GLONASS is an independent GNSS from GPS, but when combined with GPS provides additional satellite visibility and redundancy. Presently, GLONASS satellites transmit a common code on different frequencies, referred to as frequency division multiple access (FDMA) technology. This is in contrast to the GPS CDMA format of common frequencies with unique satellite codes. Besides adding to the total available satellites, including GLONASS usually increases geometrical strength. The redundancy increases the speed and reliability of the ambiguity resolution process and can give fixes in traditionally bad GPS conditions, such as urban canyons and road rights-of-way between tree canopy rows. However, GPS time is not synchronized with GLONASS time (and the GLONASS constellation orbits are broadcast in PZ 90). Thus, the receiver clock has two time-related unknowns: the difference with GPS time, and the difference with GLONASS time. These two clock terms, plus the three X,Y,Z position unknowns, are solved by having at least 5 satellites in

view, with two being GLONASS. GLONASS satellite ephemerides used by the RT survey are transformed from PZ 90 to WGS 84.

Although the receivers correctly tag the *partial* wave length after locking on to the satellites, to correctly position the rover the initial unknown number of whole carrier phase cycles at that epoch must be resolved. Subsequently, the change in phase is maintained to differentially position the rover. Loss of lock must be accounted for in order to resolve the new integer phase count. Many techniques exist to do this calculation and each GNSS software/firmware manufacturer has proprietary algorithms that aren't freely disseminated. Some basic, proven techniques used in various calculation iterations are: using combinations of frequencies as with wide laning, narrow laning, and iono free, Kalman filtering, and single/double/triple differencing. These will be briefly discussed in this section to give the user an appreciation of the complexity of calculations being done at the rover receiver and being displayed in the data collector, initially in typically under 10 seconds and with only a second (or perhaps up to three seconds) of latency in continuing positioning. See **Diagram III-1**. The results of “fixing” the initial number of integer wave lengths from each satellite on each frequency for a common epoch of data, and the relative ECEF X,Y,Z position vector from the base to the rover are obtained by using least squares adjustments to apply the differences to the base coordinates. As such, the geometry of the solution is simply an inverse from the base to the rover based on computations to each satellite on each frequency and referenced to the ECEF WGS 84 origin from the base and rover antennas. Transformations to other datums, such as North American Datum 1983 (NAD 83), are then performed using established transformation parameters. Typically, the user will work with a display of a projection, such as stipulated for the State Plane Coordinate Systems (SPC) or a local variation thereof, after *localizing* to passive local monumentation. (also known as a calibration). See **Section V**. for a discussion on localization.

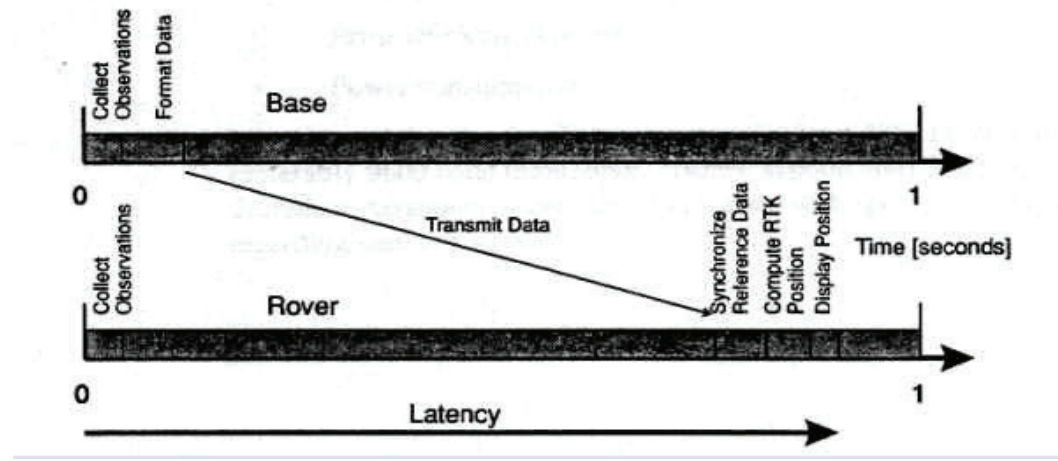

Diagram III-1 – Data Flow Latency Concept

Briefly, a RT positioning system includes base and rover GNSS units connected by a wireless data link. The rover unit is typically moved to points of interest during a survey session while the base station remains over a fixed, and usually known, location.

*** It is possible to perform an accurate RT session from an autonomous-positioned base station point if the correct position can be introduced to the project in the data collector or in the office software later.**

The autonomous base position is usually taken by selecting the position displayed after the coordinates “settle down” or start to show less variation from interval to interval- typically 30 seconds or less. Since the rover-generated positions are the result of a vector relative to the base station, the translation of the autonomous base position to a known position simply shifts the 3-D vectors in the initial X,Y,Z ECEF coordinates to originate at the new X,Y,Z ECEF coordinates and the field firmware or office software updates the RT positions accordingly, displaying the data in the user selected projection..

The base antenna should be located to optimize a clear view of the sky (Meyer, et al 2002).

***In fact, it is much better to establish a new, completely open sky view site for the base than it is to try to occupy an existing reliable, well known monument with a somewhat obscured sky view.**

Processing is based on common satellites, and the fact that the rover will usually be in varying conditions of obstruction to the sky means that it will not always be locked on the total available satellites. Therefore, the base antenna site must be optimized to look at all the possible satellites. The rover antenna will often be obstructed by trees or buildings in such a way that the signals are interrupted and a reinitialization process is performed. Each rover project site could conceivably use a different subset of the total in view constellation because of the obstructions.

Explained in an extremely general way, the rover might progress through the following algorithms in an iterative process to get a fixed ambiguity resolution. (Also, see **Diagram III-2**):

1. Use pseudorange and carrier phase observables to estimate integer ambiguities. Multipath can cause pseudorange noise which will limit this technique. Typically, this can achieve sub meter positions. Kalman filtering or recursive least square selection sets can aid in narrowing the selection set.

2. Achieve a differential float ambiguity solution (this is a decimal carrier phase count, rather than a whole number of cycles). Estimates are run through measurement noise reduction filters. Differencing reduces or eliminates satellite clock errors, receiver clock errors, satellite hardware errors, receiver hardware errors, and cycle slips.

3. Integer ambiguity search is started. Frequency combinations narrow the field of candidates. The more satellites, the more robust the integer search:

The wide lane wave length, L_w , is the difference of the two GPS frequencies, L_1-L_2 . So, “c” (speed of light) \div (1575.42 MHz – 1227.60 MHz) or 299,792.458 Km/sec \div 347.82 MHz = 0.862 m effective wave length. This longer wave length is more readily resolved compared to the L_1 frequency wave length of 0.190 m, or L_2 frequency wave length of 0.240 m. However, the wide lane combination adds about 6 times the “noise” to the observable, and about 1.28 times to the ionospheric effect.

The narrow lane wave length, L_n , is the sum of the two GPS frequencies, $L_1 + L_2$. So, c (speed of light) $\div (1575.42 \text{ MHz} + 1227.60 \text{ MHz})$ or $299,792.458 \text{ Km/sec} \div 2803.02 \text{ MHz} = 0.107 \text{ m wave length}$. The narrow wave length makes the ambiguity hard to resolve for this combination, but helps detect cycle slips, compute Doppler frequencies and to validate the integer resolution.

The “Ionosphere free” or, as commonly called, “L3” linear combination of the frequencies can eliminate most of the ionosphere error (phase advance, group code delay) in the observables but should not be relied on for the final solution for short baselines because of the additional noise introduced into the solution. The time delay of the signal is proportional to the inverse of the frequency squared - **that is, higher frequencies are less affected by the ionosphere, and hence the ionospheric time delay for L_1 observations (1575.42MHz) is less than for L_2 observations (1227.60MHz)**. The L3 wavelength is 48.44 m. However, the L_2 ionospheric error effect is approximately 1.646 times that of L_1 and noise is also increased. Still, double differenced L3 combinations can provide the most accurate solution on extended baseline lengths. Some GNSS manufacturers even set this switchover to the L3 solution at 5 km.

4. The integer ambiguity is fixed and initialization of sub-centimeter level positioning begins. Covariance matrices can be stored in certain rover configurations to enable post campaign adjustment in the office software (assuming redundancy or baseline connections).

Continual fixed ambiguity analysis is performed at the rover to verify the integer count. Ratio of the best to next best solution is evaluated. It is interesting to note that the confidence of a correct integer fix from an on-the fly-initialization is stated by most GNSS hardware manufacturers at 99.9 percent (even though an incorrect set of integer ambiguities can appear to the layman to be a better statistical choice!). RMS values of the solution and vector are produced. Once initialized, a subsequent loss of initialization new integer search is considerably enhanced when two or more satellites have been continuously tracked throughout. One or two surviving double-differenced integers bridge over the loss of initialization. This then significantly reduces the number of potential integer combinations and speeds a final integer solution, whereas complete loss of lock starts the ambiguity resolution process over again at step 1.

5. Triple differences and narrow lane frequency combinations can be used to detect cycle slips.

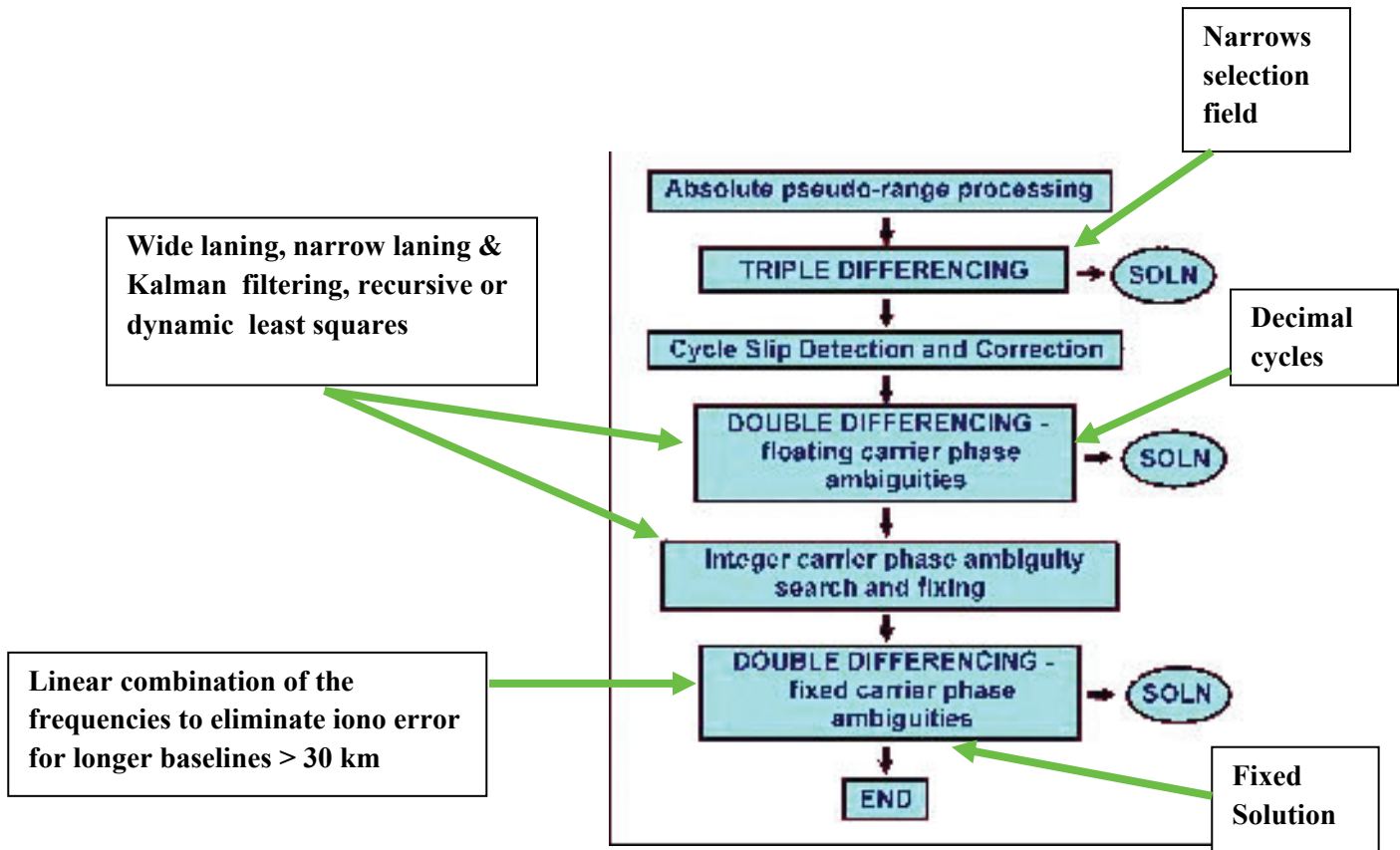

Diagram III-2 – General Flow of Ambiguity Resolution [graphic: Rizos (1999)]

See Appendix B for further discussion on differencing and ambiguity resolution.

IV. Before Beginning Work

An awareness of the expected field conditions can help produce successful campaigns. Although the conditions at all rover locations can not be known beforehand - especially for multipath conditions and obstructions - satellite availability and geometry, space weather, and atmospheric conditions can be assessed. Therefore, the following background information is provided to educate the RT user as to the many elements that are involved with accurate positioning.

All major GNSS hardware and software providers include a mission planning tool or module charting the sky plot and path of the satellites, the number of satellites and the different DOP across a time line (see **Charts IV-1, 2 and 3**). Additionally, elevation masks and obstructions can be added to give a realistic picture of the conditions at the base location. The user should expect that these would be the optimum conditions and those that the rover will experience will be less than ideal. For current satellite outages, the U.S. Coast Guard sends out a Notice Advisory to Navstar Users (NANU). Users can subscribe to this free mailing at: <http://cgls.uscg.mil/mailman/listinfo/nanu> . See **Figure IV-1** for an example.

Atmospheric conditions are difficult to predict and, as a result, the user may expect occasional surprises in the form of loss of radio communication or inability to initialize to a fixed position. Predicting atmospheric conditions for any particular area is problematic at best, but the task of how to approach this problem appears to be underway by space weather scientists and professionals. GNSS users will benefit by this heightened interest in how space weather affects our lives. For a wealth of information on the topic the reader is referred to the NOAA Space Weather Prediction Center (SWPC) web site at: <http://www.swpc.noaa.gov/>

An effort is made herein, however, to summarize some conditions and how we may get timely information which may affect our RT field work.

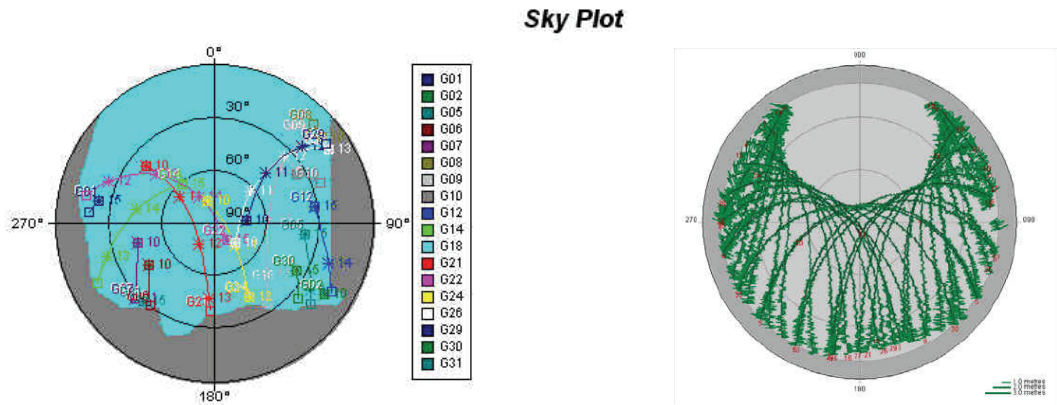

Station silver spring North 39° 0' West 77° 13' Height 100m Elevation cutoff 10° Obstacles 17%
 Satellites 30 GPS 30 [almanac06012007.alm]

Chart IV-1 Typical Satellite Sky Plots –with and without Site Obstructions

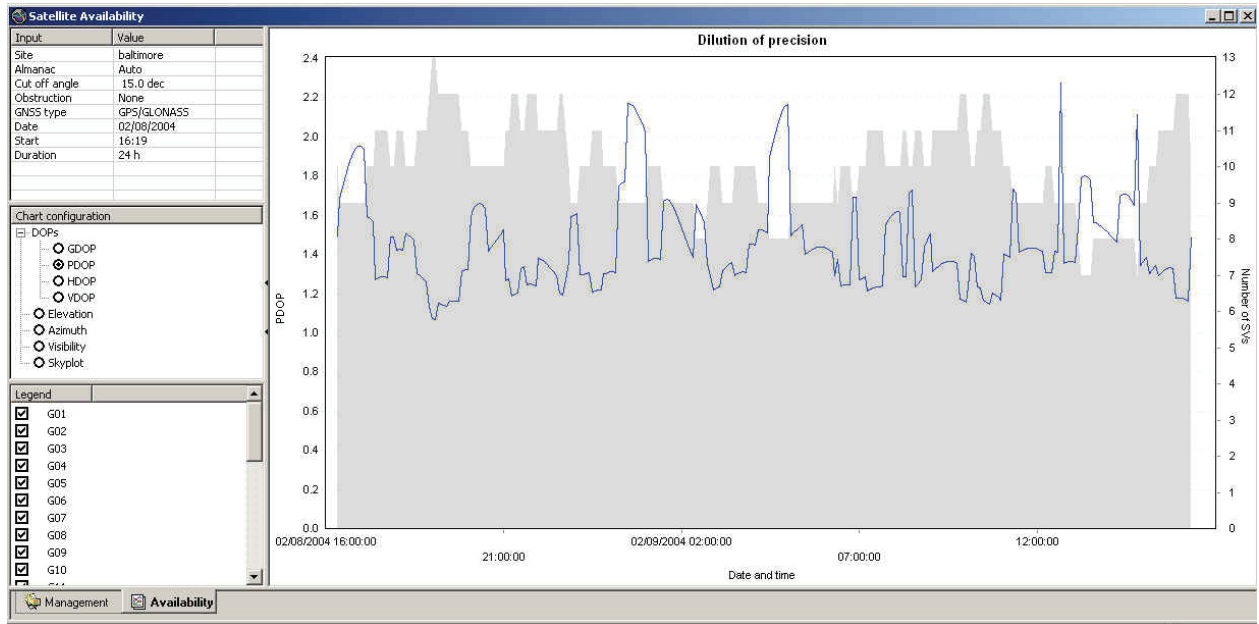

CHART IV-2 Satellite Availability and PDOP Charted Together.
(Blue line is PDOP)

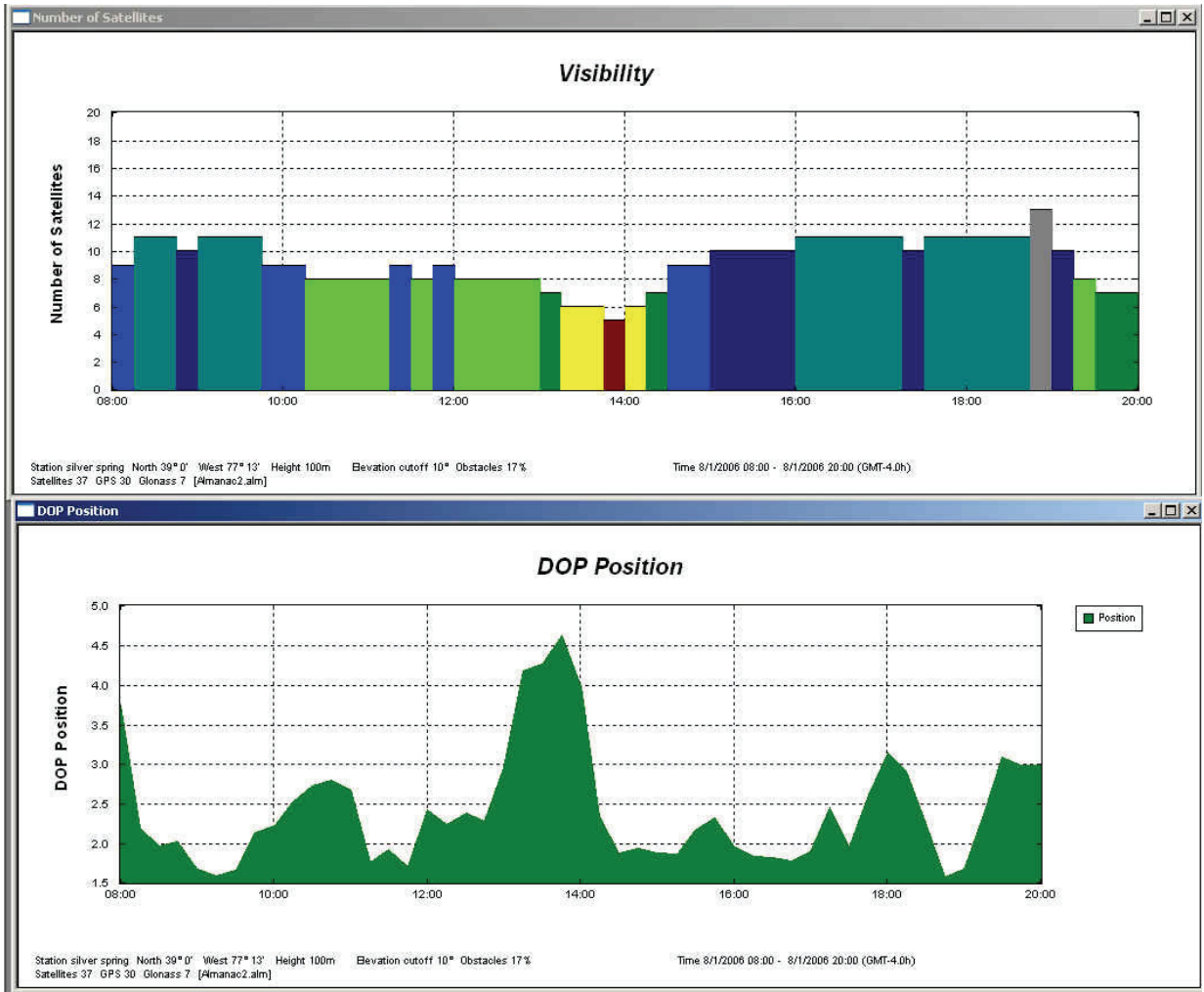

Chart IV-3 Satellite Availability and PDOP- Separate Graphs- Using Obstructions

Message: 1
Date: Mon, 27 Aug 2007 12:55:59 -0400
From: "TIS-PF-NISWS" <TIS-PF-NISWS@uscg.mil>
Subject: New NANU 2007103
To: <nanu@cglis.uscg.mil>
Message-ID:
<CA7D54DE6D7AE7479D56F1E552661EAA12ACE5@tis-exmb-m-001a.main.ads.uscg.mil>

Content-Type: text/plain; charset="us-ascii"

NOTICE ADVISORY TO NAVSTAR USERS (NANU) 2007103
SUBJ: SVN54 (PRN18) FORECAST OUTAGE JDAY 243/0130 - JDAY 243/0330

1. NANU TYPE: FCSTMX
NANU NUMBER: 2007103
NANU DTG: 271632Z AUG 2007
REFERENCE NANU: N/A
REF NANU DTG: N/A
SVN: 54
PRN: 18
START JDAY: 243
START TIME ZULU: 0130
START CALENDAR DATE: 31 AUG 2007
STOP JDAY: 243
STOP TIME ZULU: 0330
STOP CALENDAR DATE: 31 AUG 2007
2. CONDITION: GPS SATELLITE SVN54 (PRN18) WILL BE UNUSABLE ON JDAY 243 (31 AUG 2007) BEGINNING 0130 ZULU UNTIL JDAY 243 (31 AUG 2007) ENDING 0330 ZULU.
3. POC: CIVILIAN - NAVCEN AT 703-313-5900, [HTTP://WWW.NAVCEN.USCG.GOV](http://www.navcen.uscg.gov)
MILITARY - GPS OPERATIONS CENTER at [HTTP://GPS.AFSPC.AF.MIL/GPSOC](http://gps.afspc.af.mil/gpsoc),
DSN 560-2541,
COMM 719-567-2541, gps_support@schriever.af.mil,
[HTTP://gps.afspc.af.mil/gps](http://gps.afspc.af.mil/gps)
MILITARY ALTERNATE - JOINT SPACE OPERATIONS CENTER, DSN 276-9994,
COMM 805-606-9994, JSPOCCOMBATOPS@VANDENBERG.AF.MIL

Figure IV-1. Typical body of a "NANU" message

Atmospheric Errors

Disturbances and variations in the atmosphere can affect RT accuracy and integrity to the extent of making the solution too inaccurate for surveying and engineering applications as well as preventing data link communication between the base station and the rover. Atmospheric conditions can vary in relatively small geographic regions as well as in short spans of time. The two layers that are commonly modeled are broadly categorized as the ionosphere and troposphere. Charged particles in the ionosphere slow down and refract radio signals. It is a *dispersive* medium in that it affects different frequencies in a correlation to their wave lengths. The delay can actually be calculated because the rate of slowing is inversely proportional to the square of the frequency ($1/f^2$). Additionally, the "weather" in the troposphere refracts radio waves and the water vapor slows them down (wet delay), but not at the same rate as the

ionosphere. It is a *non-dispersive* medium because it affects all frequencies the same, but is site specific (or “geometrical”). So, the ionospheric error is related to the signals’ frequencies from the satellites and the effect on each frequency’s path, while the tropospheric delay is site specific to the wet and dry weather overhead in the lowest layer of the atmosphere. See **Figure IV-2** for the graphic representation of this phenomenon.

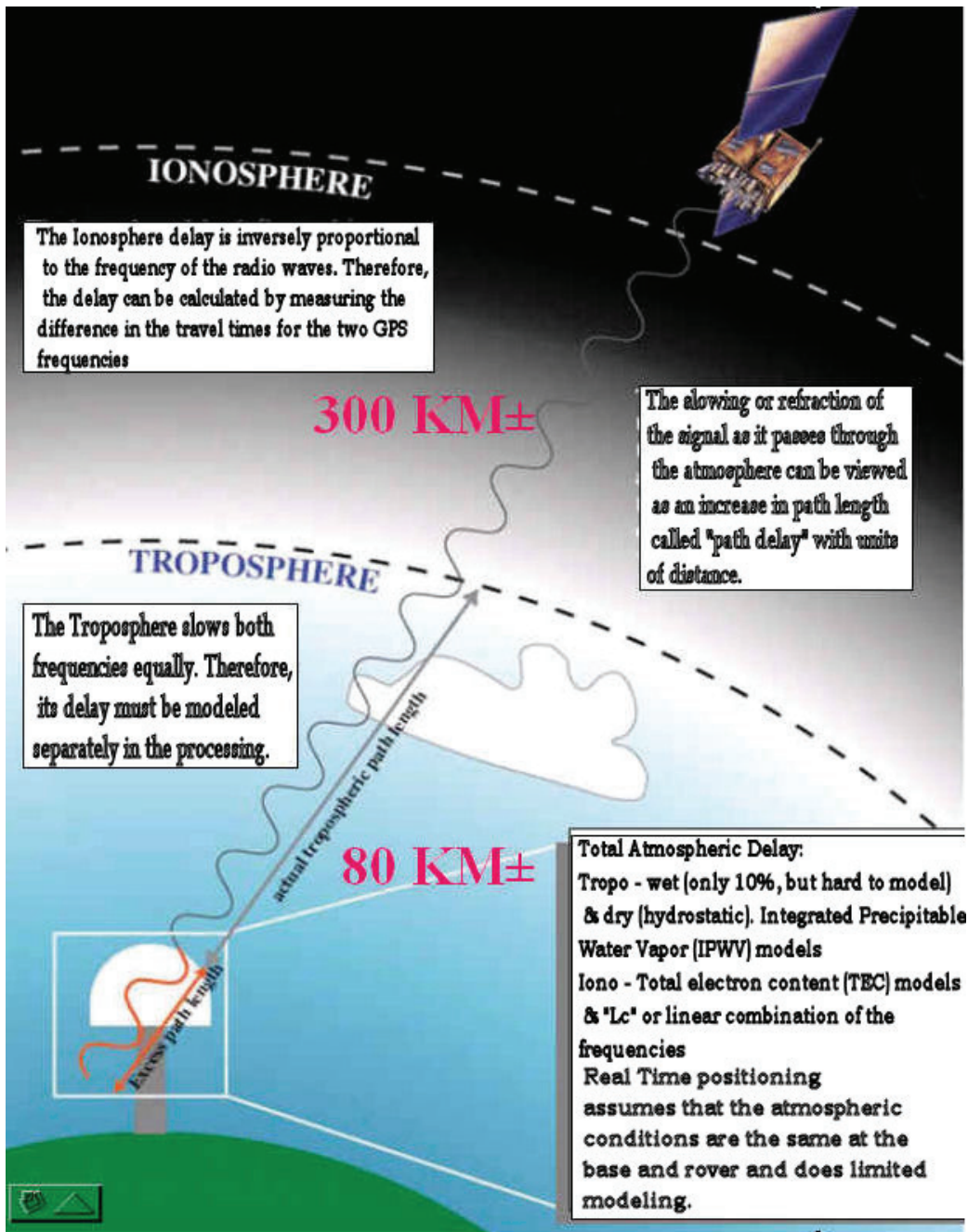

Figure IV-2 - Atmospheric Induced Refraction and Delays to the Code and Carrier

Unlike networked solutions for RT positioning, in classical (single-base) RT positioning there is minimal atmospheric modeling because it is assumed that both the base station and the rover are experiencing nearly identical atmospheric conditions. Therefore, the delays will be relative to both and would not adversely affect the baseline between them as long as baseline distances are kept relatively short (≤ 20 km) so that atmospheric conditions are not expected to differ between base and rover. For this reason, the rover computes the phase differencing corrections for the observables (each satellite and each frequency) at its position using the observables collected at the base as applied to inverse of the base position to the satellite(s) position (both “known” in ECEF, XYZ). However, a correct ambiguity resolution must be achieved to provide centimeter-level precision. Atmospheric conditions can cause enough signal “noise” to prevent initialization or, worse, can result in an incorrect ambiguity resolution. Additionally, moderate to extreme levels of space storm events as shown on the NOAA Space Weather Prediction Center (SWPC) Space Weather Scales (see link on p.18) could cause poor, intermittent or loss of, radio or wireless communication.

Ionospheric Error Discussion

Sun spots (emerging strong magnetic fields) are the prime indicators of solar activity contributing to increased ionospheric (and possibly tropospheric) disturbance. They are relatively predictable and run in approximately 11 year cycles. The last minimum was in 2006/2007 and the next maximum is expected around 2013. During an interval encompassing the solar maximum, users can expect inability to initialize, loss of satellite communications, loss of wireless connections and radio blackouts, perhaps in random areas and time spans. Therefore, it is important to understand these conditions. The charged particles in the ionosphere affect radio waves proportional to the "total electron content" (TEC) along the wave path. TEC is the total number of free electrons along the path between the satellite and GNSS receiver. In addition, TEC varies with the changes of solar and geomagnetic conditions during the day, with geographic location and with season. As the sunspot number scale increases to the next solar maximum, the impact on GNSS signals will increase, resulting in more problems even at mid latitudes which are typically not present during the benign times of the cycle. See **Figure IV-3** for the plot of the immediate past, present and predicted solar cycle.

The following is a summary of space weather conditions and how they may impact RT users as extracted from NOAA's SWPC. The SWPC provides warnings in three different categories: Geomagnetic Storm, Solar Radiation Storm and Radio Blackout. Each of these has a range from mild to severe, such as G1(mild) through G5(severe), and S1-S5 and R1-R5 inclusive.

See <http://www.swpc.noaa.gov/NOAAscales/index.html#SolarRadiationStorms> for the associated tables to explain the following categories:

1. Geomagnetic Storms - disturbances in the geomagnetic field caused by gusts in the solar wind (the outward flux of solar particles and magnetic fields from the sun) that blows by Earth. May affect satellite orientation, orbital information, broadcast ephemeris, communication, may cause surface charging. May cause inability to initialize for the GNSS user and radio problems.
**** Recommendations: Do not try to perform RT during level G3 – G5 storm events.***
2. Solar Radiation Storms: Elevated levels of radiation that occur when the numbers of energetic particles increase. Strong to extreme storms may impact satellite operations, orientation and communication. Degraded, intermittent or loss of radio communication in the northern regions are possible. May impact the noise level at the receiver degrading precision.
**** Recommendations: Do not try to perform RT during level S4 – S5 storm events.***
3. Radio Blackouts: disturbances of the ionosphere caused by X-ray emissions from the Sun. Strong to Extreme storms may affect satellite signal reception. May cause intermittent, degraded or loss of radio communication. May increase noise at the receiver causing degraded precision.
**** Recommendations: Do not try to perform RT during level R3 – R5 storm events. Be aware of possible radio problems at level R2 storm events.***

The Solar Cycle in Sunspot Number

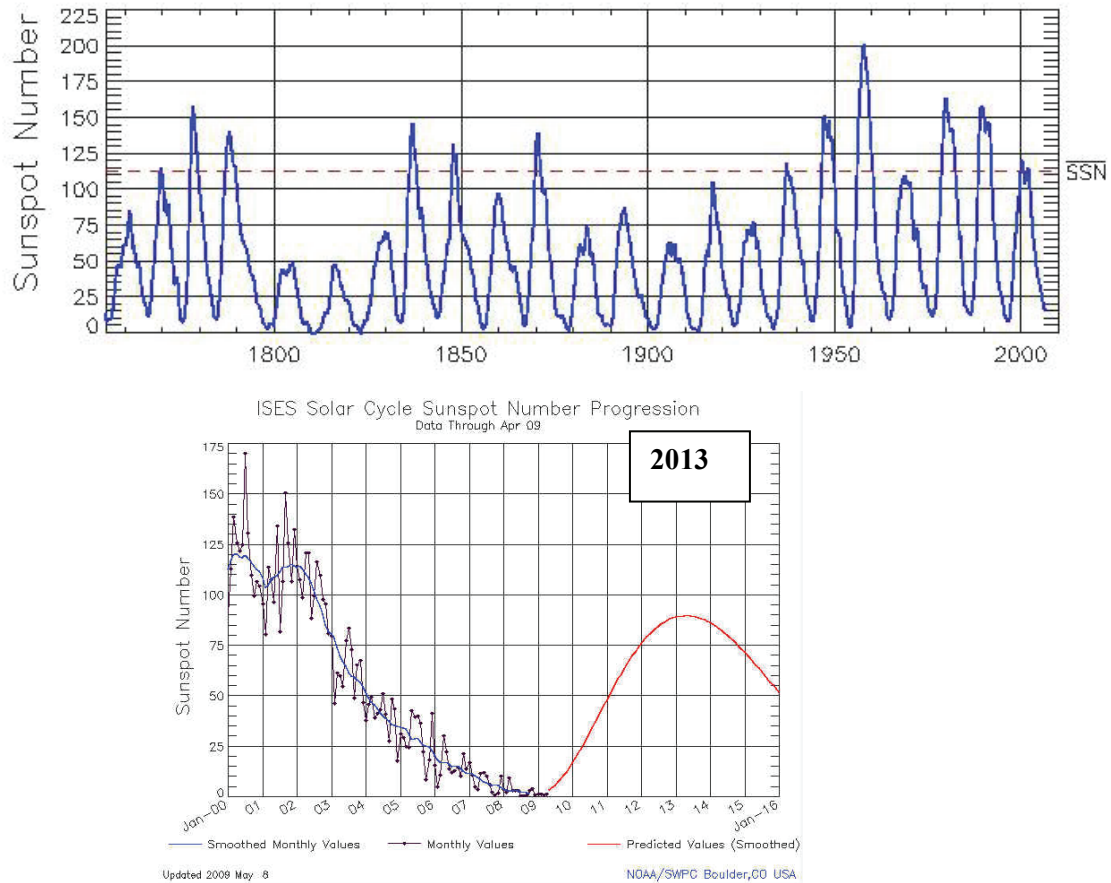

Figure IV-3 – Previous Solar Sunspot Activity and the Expected Solar Maximum in 2013 +/-

The SWPC will e-mail a number of user selected space weather updates, warnings, alerts, predictions and summaries. These can be viewed before committing to field operations. Those interested should submit the requests from the SWPC web site as referenced above. However, it must be remembered that conditions change rapidly and can not always be predicted, especially short term. The user can be aware of these conditions if field problems arise so that error sources can be known and addressed. Reobservation at a later time may be necessary. Two reports that contain forecasts are:

The Geophysical Alert Message (WWV). See **Figure IV-4**

The Report on Solar Geophysical Activity (RSGA). See **Figure IV-5**

:Product: Geophysical Alert Message www.txt
:Issued: 2007 Aug 07 0300 UTC
Prepared by the US Dept. of Commerce, NOAA, Space Environment Center

Geophysical Alert Message

Solar-terrestrial indices for 06 August follow.
Solar flux 70 and mid-latitude A-index 14.
The mid-latitude K-index at 0300 UTC on 07 August was 6 (153 nT).

Space weather for the past 24 hours has been minor.
Geomagnetic storms reaching the G1 level occurred.

Space weather for the next 24 hours is expected to be minor.
Geomagnetic storms reaching the G1 level are expected.

Thank you for using the Product Subscription Service. If you would like to remove a product subscription or update the personal information in your account, go to: <https://pss.sec.noaa.gov>. For problems, contact: <mailto:pss.help@noaa.gov>.

Figure IV-4. Geophysical Alert Message

:Product: Report of Solar-Geophysical Activity
:Issued: 2007 Aug 22 2200 UTC
Prepared jointly by the U.S. Dept. of Commerce, NOAA,
Space Environment Center and the U.S. Air Force.
#

Joint USAF/NOAA Report of Solar and Geophysical Activity
SDF Number 234 Issued at 2200Z on 22 Aug 2007
IA. Analysis of Solar Active Regions and Activity from 21/2100Z
to 22/2100Z: Solar activity was very low.
IB. Solar Activity Forecast: Solar activity is expected to be very
low to low.

IIA. Geophysical Activity Summary 21/2100Z to 22/2100Z:
The geomagnetic field has been quiet.
IIB. Geophysical Activity Forecast: The geomagnetic field is
expected to be quiet 23 - 24 August and quiet to unsettled 25
August.

III. Event Probabilities 23 Aug-25 Aug
Class M 01/01/01
Class X 01/01/01
Proton 01/01/01
PCAF Green

IV. Penticton 10.7 cm Flux
Observed 22 Aug 070
Predicted 23 Aug-25 Aug 070/070/070
90 Day Mean 22 Aug 071

V. Geomagnetic A Indices
Observed Afr/Ap 21 Aug 003/004
Estimated Afr/Ap 22 Aug 004/005
Predicted Afr/Ap 23 Aug-25 Aug 004/005-002/005-010/015

VI. Geomagnetic Activity Probabilities 23 Aug-25 Aug

A. Middle Latitudes
Active 15/15/25
Minor storm 01/01/10
Major-severe storm 01/01/05
B. High Latitudes
Active 20/20/30
Minor storm 01/01/15
Major-severe storm 01/01/10

Thank you for using the Product Subscription Service. If you would like to remove a product subscription or update the personal information in your account, go to: <https://pss.sec.noaa.gov>. For problems, contact: <mailto:pss.help@noaa.gov>.

Figure IV-5. Solar Geophysical Activity Report.

Tropospheric Delay Discussion

While tropospheric models are available as internal program components, they do not account for the highly variable local fluctuations in the wet and dry components. The dry, or hydrostatic component comprises 90 percent of the troposphere and can be well modeled (approximately 1 percent error). The wet component as water vapor is the other 10 percent, but can not be easily modeled (10 percent – 20 percent error). Furthermore, the wet delay component variances are measured in the magnitude of 10's of meters and in seconds and it is extremely hard to isolate the errors associated with this component in adjustments. Position calculation residuals result from modeling the corrections at the base versus using the “real” conditions at the rover. Also, it should be stated that tropospheric correction models introduce approximately 1mm per meter of height difference between base and rover in delay errors, which is probably not being modeled [Beutler, et al., 1989]. These contribute to a distance dependent error (along with the ionospheric conditions and ephemerides, which also decorrelate with distance from the base). The tropospheric error mainly contributes to the error in height.

**** The single most important guideline to remember about the weather with RT positioning is to never perform RT in obviously different conditions from base to rover.***

This would include storm fronts, precipitation, temperature or atmospheric pressure. Either wait for the conditions to become homogenous or move the base to a position that has similar conditions to the rovers intended location(s).

In RT positioning there exists a distance correlated error factor, i.e. the further apart the two receivers, the more the inconsistent atmospheric conditions and orbital variations will affect the precision of a computed position. These residual biases arise mainly because the satellite orbit errors and the atmospheric biases are not eliminated by differencing (see Appendix B) using the observations from two receivers. Their effect on relative position determination is greater for long baselines than for short baselines (Eckl, et al., 2002). Most GNSS hardware manufacturers specify a **1 part per million (ppm)** constant to account for this error (i.e. 1 mm/km). Therefore, this is correlated to the baseline distance. The signals traveling close to the horizon have the longest path through the atmosphere and therefore the errors introduced are hardest to correct, introducing the most noise to the position solution. Unfortunately, by raising

the data mask even higher than 15° , the loss of data becomes a problem for the integrity of the solution and may contribute to higher than desired PDOP.

*** It is helpful to partially mitigate the worst effects of atmospheric delay and refraction by setting an elevation mask (cut off angle) of 10° - 15° to block the lower satellites signals which have the longest run through the atmosphere. A 10° mask is recommended.**

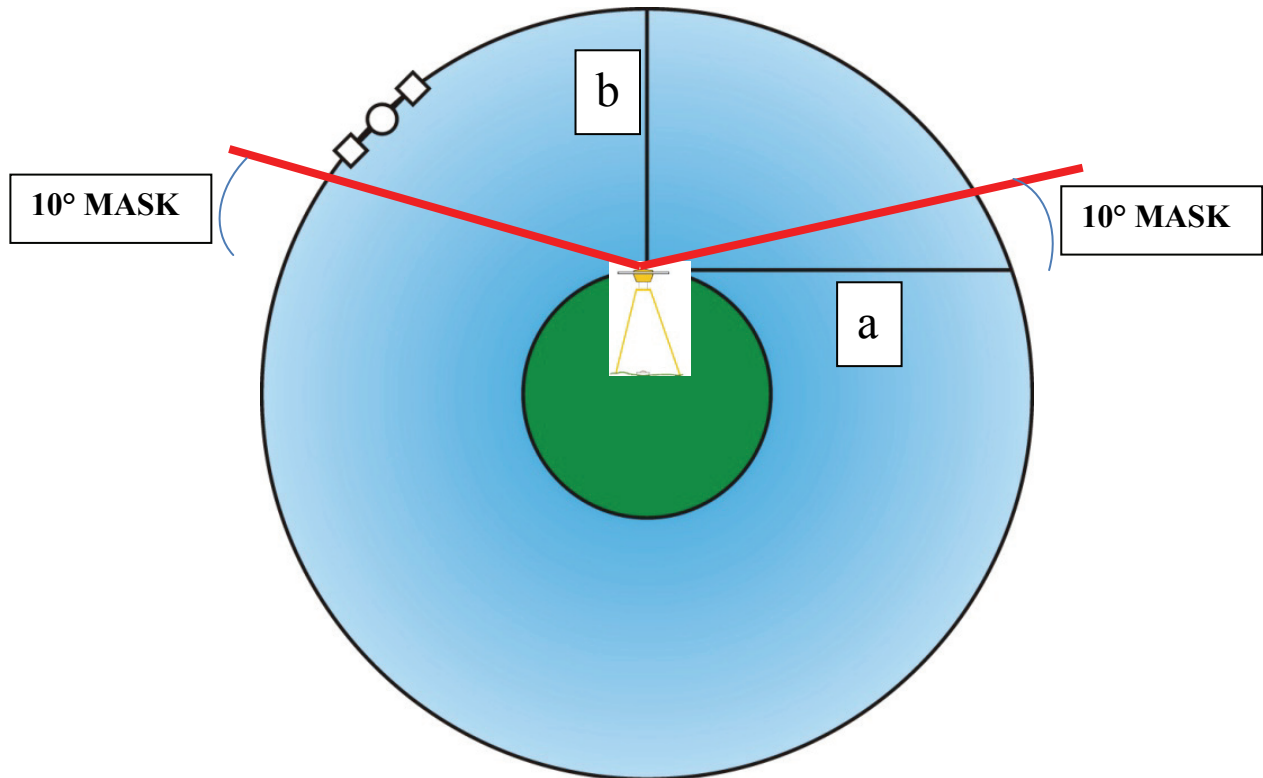

Figure IV-6. Why the topocentric location of receivers gives rise to GNSS signal paths of differing lengths. Satellite signal path “a” is longer and therefore travels through more atmosphere than ‘b’, resulting in more signal noise (3-5 times more at low elevations relative to zenith). The 10° mask angle eliminates this noisy data but still retains most of the available signal.

V. Field Procedures

The control of a classical RT positioning survey is always in the hands of the rover. Because of the variables involved with RT therefore, this section is the core to achieving accurate positions from RT.

The following are all terms that must be understood and/or monitored by RT field technicians:

Accuracy versus Precision

Multipath

Position Dilution of Precision (PDOP)

Root Mean Square (RMS)

Site Localizations (a.k.a. Calibrations)

Latency

Signal to Noise Ratio (S/N or C/N₀)

Float and Fixed Solutions

Elevation Mask

Geoid Model

Additionally, the following are concepts that should be understood. Please see the RT positioning glossary (herein) for brief definitions:

Carrier Phase

Code Phase

VHF/UHF Radio Communication

CDMA/SIM/Cellular TCP/IP Communication

Part Per Million (PPM) Error

WGS 84, ITRS versus NAD 83

GPS and GLONASS Constellations

Almost all of the above were facets of satellite positioning that “the GPS guru” back in the office worried about with static GPS positioning. Field technicians usually worried about getting to the station on time, setting up the unit, pushing the ON button and filling out a simple log sheet. Plenty of good batteries and cables were worth checking on also. While the field tech still needs plenty of batteries and cables, she or he now needs to have an awareness of all the important conditions and variables in order to get good RT results – because in RT positioning, “It Depends” is the answer to most questions.

Accuracy versus Precision

An important concept to understand when positioning to a specified quality is the difference between “accuracy” and “precision”. The actual data collection or point stake out is displayed in the data collector based on a system precision which shows the spread of the results (RMS) at a certain confidence level and the calculated 2-D and height (horizontal and vertical) solution relative to the base station in the user’s reference frame. In other words, it is the ability to repeat a measurement internal to the measurement system. Accuracy, on the other hand, is the level of the alignment to what is used as a datum, i.e. to externally defined standards. The “realization” of a datum is its physical, usable manifestation. Therefore, accuracy can be “realized” by published coordinates on passive monumentation such as is found in the NGS Integrated Data Base (NGS IDB), by locally set monuments, or by assumed monuments. Accuracy can also be from alignment to active monumentation such as from the NGS Continuously Operating Reference Station (CORS) network or a local RTN. The geospatial professional must make the choice of what is held as “truth” for the data collection. It is expected that the same datum, realized at the same control system monumentation, is held from the design stage through construction for important projects. A professional surveyor, or other qualified geospatial professional, should be involved to assess the datum and its realization for any application. The alignment to the selected truth shows the *accuracy* of survey. For example, as stated in the NGS 59 document for GPS derived orthometric heights (Zilkoski, et al, 2005), accuracy at the datum level (North American Vertical Datum of 1988 - NAVD 88), is less accurate than the local accuracy between network stations. Ties were shown at a 5 cm level to the national datum, while local accuracies can be achieved to the 2 cm level. Subsequent project work done with classical surveying instruments (but still in NAVD 88) could be done at much higher *precision*- perhaps at the millimeter level, but the *accuracy* of the tie to the national datum is still 5 cm at best. Because RT positions are being established without the benefit of an internal network adjustment, accuracy at any one point is an elusive concept. It can be seen that if the base station is correctly set up over a monument whose coordinates are fully *accepted as truth*, correct procedures are used, and environmental conditions are consistent, then the precision shown would indeed indicate project accuracy. Redundant observations on data points can provide a means to tweak the coordinates in the office software post campaign, but the data are usually not sufficient for a full least squares adjustment.

Therefore, to get a sense of the accuracy achieved, it is recommended that the user's survey be based on proven control monumentation with a high degree of integrity, the data precision is monitored as the work proceeds, points with known values are checked before, during and after each RT session, and redundant locations are taken on each important point.

Multipath

Multipath error can not be easily detected in the rover or modeled in the RT processing. Basically, anything which can reflect a satellite signal can cause multipath and introduce error into a coordinate calculation. When a reflected signal reaches the receiver's antenna, the transit time is interpreted as if the signal took a direct path from the satellite, even though it in reality took a longer time by being reflected. This would "trick" the receiver into using the longer time (or therefore, longer distance) in its solution matrix to resolve the ambiguities for that satellite. This bias in time/distance introduces noise to the solution (much like a "ghost" on a television with a bad rabbit ears antenna) and can cause incorrect ambiguity fixes or noisy data (as may be evidenced by higher than expected RMS). Multipath is cyclical (over 20 minutes -25 minutes typically) and static occupations can use sophisticated software to model it correctly in post processed mode. The rapid point positioning techniques of RT prevent this modeling. Trees, buildings, tall vehicles nearby, water, metal power poles, etc. can be sources of multipath. GNSS RT users should always be aware of these conditions.

***Areas with probable multipath conditions should not be used for RT positioned control sites -especially not for a base station position. These sites include locations under or very near tree canopy, structures within 30 m that are over the height of the antenna, nearby vehicles, nearby metal objects, abutting large water bodies, and nearby signs.**

Because the typical RT occupation will only be anywhere from a few seconds to a few minutes, there is not enough time to model the multipath present at any point. Indeed, the firmware in the rover receiver and data collector will not address this condition and will continue to display the false precision as if multipath was not present. Besides contributing to the noise in the baseline solution, multipath can cause an incorrect integer ambiguity resolution and thus give gross errors in position- particularly the vertical component. It has been seen to give height errors in excess of 2 dm because of incorrect ambiguity fixes and noise. Multipath isn't always

apparent and it's up to the common sense of the RT user to prevent or reduce its effects. It is recommended to get redundant observations with different satellite geometry (3 hour staggered times) to help mitigate multipath error.



Multipath Conditions can cause unacceptable errors by introducing noise and even incorrect ambiguity resolution because of signal delay.

Position Dilution of Precision

PDOP is a unitless value reflecting the geometrical configuration of the satellites in regard to horizontal and vertical uncertainties. Stated in a simplified way, DOP is the ratio of the positioning accuracy to the measurement accuracy. Error components of the observables are multiplied by the DOP value to get an error value compounded by the weakness in the geometrical position of the satellites as can be shown relative to the intersection of their signals. This is depicted in **Diagrams II-2 and 3**. Therefore, lower DOP values should indicate better precision, but cannot be zero, as this would indicate that a user would get a perfect position solution regardless of the measurement errors. Under optimal geometry with a large numbers of satellites available (generally 13 or more), PDOP can actually show (usually very briefly) as a value less than one, indicating that the RMS average of the position error is smaller than the measurement standard deviation. PDOP is related to horizontal and vertical DOP by:

$PDOP^2 = HDOP^2 + VDOP^2$. Another DOP value – Relative Dilution of Precision (RDOP) has been researched as a better indicator for the effects of satellite geometry for differential carrier phase positioning (Yang, et al, 2000). However, because most data collectors display PDOP during field positioning, it remains the value that these guidelines must address.

See the different **Accuracy Classes** in this section for suggested PDOP values.

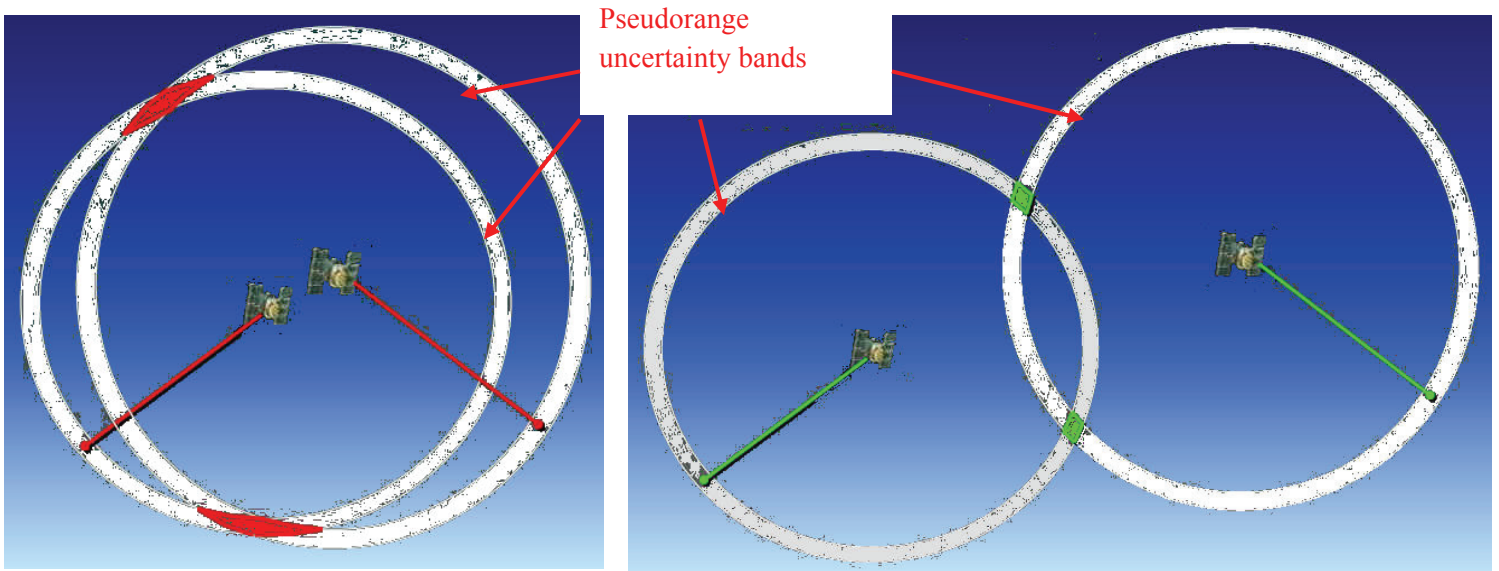

Diagram II-2

Diagram II-3

High PDOP- Satellites Close Together

Low PDOP – Satellites Spread.

Note the difference in area of the intersections. In a three - dimensional sense with multiple satellites, it would be reflected in the difference of hyperbolic intersections displayed in polyhedron volumes. Mathematically, the lowest possible volume polyhedron formed by the signal intersections would have the lowest PDOP.

Root Mean Square

RMS is the statistical measure of precision (not accuracy) that typically can be viewed in the data collector. RMS indicates the numeric quality of the solution related to the noise of the satellite ranging observables. It is independent of satellite geometry. Many data collectors display this as a 1σ (one sigma or 68 percent confidence) level. The user should double these horizontal and vertical values to see the approximate precision at the desirable 95 percent confidence level.

***When viewing the RMS on the data collector screen, the user should be aware of the confidence level. Some displays show a 68% confidence for the horizontal and vertical precision.**

Constraining to Passive Monuments

Horizontal + ellipsoid height positions are readily and accurately obtained from active stations, such as those in the national CORS system which serves as the realization of our NAD 83 datum. However, the orthometric height component of a single baseline RT position is usually based on passive monumentation, where high vertical accuracy order bench mark monuments are the realization of the NAVD 88 datum. Using single base RT procedures, the user typically promulgates the base station horizontal position and orthometric height to the collected data on points of interest in her or his work. Regardless of the base station's accuracy level in its alignment to the horizontal and vertical datums (see p. 30), the rover's position can never by RT practice be more accurate than that of the base (the rover is solely aligned to the base in this case and thus has no other connection to the datum. Also, recall: the ppm error associated with single base RT, the error in an applied hybrid geoid model, the variation in the obtained coordinates by atmospheric conditions and other satellite related factors, and possible multipath noise). Several issues arise from this methodology in regard to the actual "ground truth" of the obtained positions:

Case 1 - One passive monument as truth. It can be seen that if the base station occupies a stable, trusted monument of verified accuracy, whose position and orthometric height are known to be in a certain datum or projection and/or with a certain orthometric height or elevation, then the RT points obtained in a local project sense will reflect a certain *precision* in relation to the base and an *accuracy* correlated to that of the base's alignment to the referenced datums (see

page 26, this section). When using this base as the “truth”, the user enters the horizontal and vertical coordinates of the point into the data collector. These coordinates may be references to the monument’s physical location on the ground using a project “height” (usually causing a one point tangent ground projection), or they may be referenced to a transformation defined in the data collector firmware – causing data points to be essentially taken on that projection surface (and therefore not ground based). For example, if the base monument coordinates are entered as being referenced to a grid coordinate projection such as SPC, whose transformation from the WGS 84 (GPS) datum is built into the collector’s firmware, the points of interest are located by the rover as grid coordinates and inversed distances will not reflect ground distances. It is possible to automatically apply a combined factor to these generated points to reflect the project scale and ellipsoid height factors at the project site. However, the user must be aware that this will create “ground” coordinates that look similar to the grid coordinates but differ from the grid values at the same point. Many GNSS practitioners select one published orthometric height (or other local height) on one monument to act as project truth, and thus shift all heights based on this “vertical reference datum” - whether as thought to be aligned with a particular datum or not. Since only one passive monument is constrained, it is critical that check shots be taken before collecting new data. It should be remembered that a hybrid geoid model can still be applied to the point data collected.

Case 2 – Unknown base station coordinates. RT locations can proceed from a local tangent projection established from an autonomous point. Usually, the vectors are shifted post campaign to the correct position coordinates of the base station that is entered . It is also possible to do a “GPS resection”, where other trusted monuments surrounding the project are visited by the rover. The GNSS locations are used in the collector to establish a refined coordinate on the previously autonomous value of the base station. This is essentially part of a routine known as a “calibration” or “localization” to many users, as in **Case 3**, and establishes a planar projection surface that is best fit to the coordinates entered.

Case 3 - Constraining multiple passive monuments around a project. Many users practice in areas where passive monumentation has been used over many years and in many projects. Indeed, local regulations or requirements may even dictate that these passive monuments be used for all work. In areas where the user wishes to constrain his or her work to these legacy passive monuments, or even to non-geodetic values, site localizations can be performed. These passive

monuments may or may not be precisely aligned to a particular datum, but would be proper to use for the sake of project accuracy, continuity and construction compatibility. Using the GNSS manufacturer's firmware in the field or software in the office, it is a relatively easy task to perform a least squares best fit to these monuments. The user's software/firmware performs a rotation, translation and scale transformation from the WGS 84 datum realized in the broadcast satellite ephemeris, to a local projection as realized on physical monuments visited in the field survey (the GNSS manufacturer's software performs an intermediate step to a project oriented projection - Transverse Mercator for example). The coordinates entered for these monuments establish a best fit planar projection – either horizontal, vertical, or both, depending on what is entered and constrained. Residuals are reviewed for outliers. The user should be extremely careful in what is considered an outlier in this adjustment. It is possible that one monument is “correct” to the user's reference frame and all the others in the adjustment are the outliers. The user must know the quality of the passive monuments.

Because of its built-in capabilities, most RT users utilize this method. However, like much of the high precision work produced, the results must be reviewed by a competent geospatial professional.

***RT localizations allow the user to transform the coordinates of the control monumentation positioned with their RT-derived positions in the WGS 84 datum, to the user datum (even if it's assumed) as realized by the user's coordinates on the monuments.**

Before performing a localization, the project site should be evaluated and after control research and retrieval, the monumentation coordinates to be used for the localization should be uploaded to the field data collector.

*** To have confidence in a site localization, the project site must be surrounded by at least 4 trusted vertical control monuments and 4 trusted horizontal control monuments which to the greatest extent possible, form a rectangle.**

The monuments can be both horizontal and vertical control stations, but should be of sufficient accuracy to be internally consistent to the other localization control at a level greater than the required RT project accuracy. Adding more trusted control that meet these criteria will add to

confidence in the localization, especially if they can be spaced throughout the project area. For the limiting accuracy of RT field work, many GNSS software and hardware manufacturers state their RT positioning accuracies as 1 cm + 1 ppm horizontal and 2 cm + 1 ppm vertical (at the 68 percent or one sigma level). This is further substantiated by published ISO testing standards in ISO/PRF 17123-8 (ISO, 2008). Thus, for a localization control spacing of 20 km, the localization adjustment statistics might be recommended to show less than a 2 cm horizontal residual and less than a 4 cm vertical residual at a 95 percent confidence (twice the confidence of the RT work done with 68 percent confidence). Site localizations can be performed in the field by a competent RT user and imported into the office GNSS software, or performed in the office and uploaded to the data collector. The firmware/software will yield horizontal and vertical residuals which must be reviewed to check for outliers. It can be seen that this is a good way to assess the relative accuracy of all the existing project control. It must be remembered, however, that any localization performed to the passive marks takes coordinates whether ground based or not and fits them to the physical marks (and thus imparts a scale factor).

****It is critical that all project work is done using the same correct and verified localization. Different localizations can result in substantially different position coordinates***

Case 4 – Performing a quick geodetic transformation to a local project projection

It is possible to do a relatively quick transformation computation from an established datum, such as NAD 83, to a ground-based local project map projection in the office prior to the field campaign, or even in the data collector while in the field. Many larger map projection areas that might be county-wide or regional, but still ground based, can also be established with a little more computational work. The goal is to minimize linear distortion at the topographic surface, which requires use of projections with a unique scale factor at every point (i.e., conformal projections). The advantages of using this method are several (Dennis, 2008):

1. The definition is cleaner in that it has no appearance of state plane coordinate values, (typically) has smaller coordinate values, and does not create another datum as would be the case of scaling the ellipsoid to ground.
2. It is more readily compatible with GIS and other mapping, surveying, and engineering software.
3. It generally covers larger areas with less distortion than a state plane projection taken to ground.

4. It can be designed in a manner that minimizes convergence angles (and hence arc-to-chord corrections), which is unchanged by a modified state plane transformation.

Either a Transverse Mercator (TM) projection or one parallel Lambert Conformal Conic (LCC) projection will work adequately for areas under less than about 35 miles wide (about 1000 square miles if more-or-less equidimensional). For larger areas, Earth curvature begins to have a noticeable impact on the distortion, at which point the type of projection used becomes more important. Other common conformal projections that can be used are the Oblique Mercator and the Oblique Stereographic. For small areas, it is recommended to use a Transverse Mercator projection unless inadequate for the site, since it is the projection most widely supported in software (although this limitation is decreasing as more vendors add more projections to their software).

This method requires proper metadata to maintain the geodetic trail back to the datum. These data include: The geometric reference system (i.e., datum), datum realization tag, datum epoch (time) reference, linear unit, and the projection definition. This latter item consists of the latitude and longitude of grid origin, false northings and eastings at the grid origin, and the scale factor applied to the central meridian (for TM), standard central parallel (for LCC), or skew axis (for OM) along with skew axis azimuth.

A local low distortion projection is defined directly from the datum based on the local topography and is exclusive of the passive realization of that datum. Obviously, the passive marks used for control within the project area should be validated once the projection is defined (which is true regardless of the coordinate system used). It is possible to refine the scale factor to better fit the passive control if necessary, or to refine it based on a detailed analysis of distortion at the topographic surface. The steps necessary to create a local projection are summarized below (a more detailed procedure is given in Appendix E):

1. Define the project area and choose a representative ellipsoid height (h_0).
2. Place the projection axis (central meridian for TM, standard parallel for LCC) near the center of the project.
3. Compute the scale at the project axis using h_0 . Use the formula:

$k_0 = 1 + (h_0 \div R_E)$, where k_0 = scale at projection axis, R_E = radius of earth (ellipsoid) at the project latitude (a geometric mean radius of curvature of 6,373,000 m or 20,910,000 ft works reasonably well for the coterminous US). Round k_0 to five or six decimal places (use at most seven for small areas).

4. Define false northing and easting for an origin so that all project coordinates are positive. Make the coordinates at the central meridian and a parallel of origin

(south of project) using the smallest integer values that give positive coordinates everywhere in the area of interest. Also define the latitude and longitude of grid origin (including central meridian and standard parallel, as applicable) to no more than the nearest arc-minute. The purpose of this step (and rounding k_0 to six decimal places) is to provide a clean coordinate system definition.

Check passive control (or points of known topographic height) at the project extremes for distortion (both in extremes of area and height). If the computed distortion based on these ellipsoid height check points is too high, the projection axis scale factor can be adjusted to reduce distortion.

See Appendix E for an extensive discussion and example of this scale-refining approach for a county coordinate system based on the TM projection.

Latency

Latency is the delay of the received satellite signal data and correction information at the base to be wirelessly broadcast, received by the rover radio, transferred to the rover receiver, have corrections computed and applied for the current common epoch, sent to the data collector and displayed for the user. The position the user views on the data collector screen can be up to 5 seconds old, but typically an effective latency of 2 or 3 seconds is the maximum experienced. The data can be updated (or sampled) at a much higher rate, say 5 Hz, but the usable coordinate is usually produced at .33 to 1 Hz. It is recommended to use data with latencies no greater than 2 seconds.

Signal to Noise Ratio

Receivers must process GNSS signals through background noise. This can be from atmospheric conditions, radio frequency interference or from hardware circuitry. Since GNSS signals are relatively weak (the total transmitted power from a satellite is less than 45 w!), it is important to use data that doesn't fall below acceptable noise levels (a common level is given as 30 dB). Signal-to-noise ratio (SNR) can be an indicator of multipath, if other contributing noise factors, such as antenna gain, can be removed. The signal-to-noise ratio is the ratio of the average GNSS signal power to the average level of background noise, often given in decibels (dB). The higher the ratio, the less obtrusive is the background noise. The signal to noise ratio is

denoted by the abbreviation S/N or SNR (or sometimes carrier signal amplitude over 1 Hz = C/N_0). It is usually based on a decibel base 10 logarithmic scale. Most GNSS firmware in the data collectors are capable of displaying this value on some kind of scale. Unfortunately, unlike GPS code and phase observables, a standard practice for computing and reporting SNR has not been established. Thus, the value and the units used for reporting SNR differ among manufacturers. At this time it is not possible to give independent numerical values to the SNR for all receiver brands. Therefore, the only recommendation made is to refer to each manufacturer's reference material and support system to try to ascertain a minimum SNR (or C/N_0). Some considerations to ponder include:

1. NMEA message type GSV supposedly shows C/N_0 in dB.
2. Current Rinex 2.10+ versions allow the SNR to be reported in the original observations.
3. Comparison of SNR between satellites can show the source of the cleanest data.

(See Langley, 1997)

Float and Fixed Ambiguities

In the quest to resolve the ambiguous number of whole carrier cycles between each satellite and each GNSS receiver's antenna that will be added to the partial cycle which the receivers' record after locking on to the satellites, many iterations of least squares adjustments are performed. A first list of candidates produces a set of partial whole cycle counts, that is, a decimal number to each satellite for each frequency. This decimal cycle count is said to be the "float" solution – one that still has not yet forced the number of whole cycles to take an integer value. Usually while stationary, the positional RMS and horizontal and vertical precisions will slowly decrease as the rover receiver iterates solutions. The user will see these indicators go from several meters down to submeter. Sometimes the solution rapidly goes to fixed and these iterations are not seen.

***The user must be aware of the solution state and should wait until the solution is displayed as fixed before taking RT observations.**

As soon as the solution is “fixed” and the best initial whole number of cycles has been solved, the data collector will display survey grade position precision at the sub-centimeter level.

Elevation Mask

Because GNSS satellite signals have the longest paths through the atmosphere at low elevations from the horizon, it is advantageous to set a cut off angle to eliminate this noisy data. The base station and rover are typically set to an elevation mask of between 10° and 15°. In addition to this mask, individual satellites can be switched to inactive in the firmware. This may be of some advantage where there are many satellites available but due to obstructions, a certain satellite may be at a higher noise level and become a detriment to a robust solution. Typically, the satellites elevations and azimuths can be viewed graphically in a data collector screen. It is recommended to set the elevation mask to at least 10° to eliminate the noisiest data (but not more than 15° so as not to eliminate usable data).

The NGS Hybrid Geoid Model

The NGS has for a number of years provided a hybrid geoid model from which users of GPS could take the field-produced NAD 83 ellipsoid heights and compute NAVD 88 orthometric heights in the continental USA, being also introduced in Alaska in 2007. The hybrid geoid model gives a distance or separation between the two surfaces defined as NAD 83 and NAVD 88. Although this model has been consistently updated, densified and improved, it is expected that the resolution of the model would lead to interpolation errors or residuals. As of this writing, users can expect relative elevation accuracy of 4.8 cm (2 sigma) internal accuracy, which includes GPS observation error. Error in the geoid is expected at about 2 cm (2 sigma) at about 10 km wavelength. Nothing can really be said about absolute accuracy because of the very

irregular data spacing (some regions are very sparse while others are saturated). Hence, while the apparent local accuracy might look good, that may be due to the fact that only a few points were available and were easily fit. That being said, many parts of the USA are extremely well served by applying the hybrid geoid model. Height Modernization practices (see <http://www.ngs.noaa.gov/heightmod/>) can produce 2 cm local orthometric height accuracy from static GPS procedures. It is incumbent upon the GNSS RT user to know the resolution, accuracy and gradient slope of the local geoid model for his or her project area. In the user's data collector, manufacturer's RT algorithms can apply the hybrid geoid model with or without an inclined plane produced from a localization.

***For best vertical results, it is recommended to apply the current hybrid geoid model in addition to any localization to the vertical control.**

Communication Links

It is important to reiterate that user expertise and knowledge enables accurate data collection where inexperience may yield less than satisfactory results. A prime example is communication integrity. When radio or cellular communication becomes intermittent or erratic but does not fail, positional data can degrade in accuracy. The exact reasons for the lowering of accuracy appear unclear due to proprietary firmware algorithms, but perhaps are related to the variation in the latency of data reception. Regardless, this condition should be handled with caution if the point accuracy is of any importance. Also, there are areas where cell voice coverage is strong but data communication is intermittent (and vice versa). Furthermore, if the rover firmware takes an extended time (much longer than a normal fix time) to resolve the ambiguities and display a fixed position, there could be an incorrect cycle count resolution and the accuracy would be insufficient for surveying or engineering applications. As with multipath, there is no specific indication in the data collector that there is a bad fix except perhaps an increase in RMS error. The good news is that the receiver is constantly doing QA/QC on the ambiguity resolution strength. Indeed, it is stated in various GNSS equipment manufacturers' literature that newer receivers use better RTK algorithms and as a result produce better accuracy over longer baselines and lower elevation masks with a higher signal to noise ratio and, one would assume, more robust ambiguity resolution. (See Appendix A for a case study of

positioning over various baseline lengths in Vermont by NGS Geodetic Advisor Dan Martin, using newer GNSS units). As a good practice, therefore:

***To collect important positional data, the communication link should be continuous. The GNSS solution should become fixed in a ‘normal’ amount of time and should remain fixed for the duration of the data collection at the point.**

A “normal” time period is one which has been seen by the user to produce a reliable ambiguity resolution from a local base station in past data collection campaigns using proper conditions and procedures.

Checks on Known Points

Single-Base RT field work requires a confidence that each base set up is done correctly - otherwise, the errors will be biases in every data point created from the set up.

***Before beginning new point data collection, a check shot should ALWAYS be taken on a known point.**

This should provide a method of detecting set up blunders, such as incorrect antenna heights or base coordinates. It also provides a check on the initialization or ambiguity resolution. Periodic checks on known points should also be done as work progresses. Finally, a check should be done before the end of the set up. The user should decide what points in their project area are suitable for checks. For work in the higher accuracy classes it is recommended to check known and trusted high stability monuments, such as those of high integrity found in the NGS data base. If none are available near a particular project, perhaps a point previously located from such a monument could be used as verification that the RT set up is of the desired accuracy. It is possible to travel with a vehicle and keep the rover initialized. Magnetic antenna mounts are available to keep the antenna accessible to the sky and thus to the satellites. It should be noted however that passing under a bridge or overpass or traversing a tunnel will obviously cause loss of lock at the rover, requiring a reinitialization.

Generally,

***To collect important positional data, known and trusted points should be checked with the same initialization as subsequent points to be collected.**

An ‘important point’ may be, for example, any point established by RT to be used as a control station for further data collection or a photo control reference point. “Known and trusted” points are the existing high accuracy points in the project envelope.

Accuracy Classes

The term “accuracy” in this case, actually refers to the precision from a base station correctly set over a monument held as truth. The accuracy of the rover positions will be less than the accuracy of the base station’s alignment to the user’s datum.

****It is important to know what accuracy is needed before performing the RT field work.***

Besides the previously stated guideline for continuous communication and fixed ambiguities, for these guidelines the equipment must be in good working condition. This means: no loose tripod legs, the actual fixed height has been checked (worn fixed height pole feet, unseated pole feet and variability in the height settings in those fixed height poles using dowels to hold a particular height can yield biases of millimeters to even a centimeter in base heights), strong batteries are used, the units perform to manufacturers specs (ISO, 2008), the level bubbles have been adjusted (see Appendix C). Further assumptions are: there are no blunders in data collection or entered pole heights, the rover and base are GPS dual frequency with or without GLONASS, and are receiving observables with a cut off angle (elevation mask) of 10° to 15°, the base has been positioned in as open a site as possible with no multipath or electrical interference, that it occupies an adjusted control point within the site localization (if any), and its coordinates have been correctly entered as the base position.

Accuracy Classes Rationale

Listed below are data collection parameters to achieve various accuracies with a strong amount of confidence (95 percent level). These have been developed from years of best practices from the experiences of many RT users and also reflected in some existing guidelines (e.g. Caltrans, 2006). The rationale for publishing these guidelines without extensive controlled scientific testing is correlated to their use life and the needs of the user community. To run controlled experimentation with the plethora of variables associated with single base RT

positioning would take an inordinate amount of time and effort and would likely produce results that would be outdated by the time of their release. To meet the needs of the large RT user community in a timely manner, the decision was made to employ best practices that could be adjusted to meet actual valid field location results as needed. Additionally, the changing GNSS constellations and other new or improving technologies require a dynamic stance with these guidelines. New signals, frequencies and satellite constellations will undoubtedly change the recommended procedures and accuracy classes that follow. Finally, the rapid growth of RTN stresses the need to port these single-base guidelines to those for users of the networked solutions rather than spend extensive time in research for single-base applications.

Guidelines and Procedures for NGS Real-Time Accuracy Classes

Note: Empirically, it has recently become evident that using newer GNSS hardware, firmware and algorithms, may produce the various following accuracies over much longer baseline distances. Additionally, redundant positions at staggered times are showing a much closer numerical comparison than previously seen (e.g., see Appendix A). This may mean that the Class RT1 accuracies could be obtained using the criteria for Class RT2, etc. Regardless of this, the user should at least be able to achieve the desired accuracy by using the appropriate criteria herein.

Class RT1 Precisions: typically 0.01 m – 0.02 m horizontal, 0.02 m – 0.04 m vertical (two sigma or 95 percent confidence), two or more redundant locations with a staggered time interval of 4-hours from different bases adjusted in the project control, each RT location differs from the average no more than the accuracy requirement. Discard outliers and reobserve if necessary. Base stations should use fixed height tripods. Baselines ≤ 10 KM (6 miles). Data collected at a 1-second interval for 3 minutes (180 epochs), PDOP ≤ 2.0 , ≥ 7 satellites, position solution RMS ≤ 0.01 m. No multipath conditions observed. Rover range pole must be firmly set and leveled with a shaded bubble before taking data. Use fixed height Rover pole with bipod or tripod for stability.

Class RT2 Precisions: typically 0.02 m – 0.04 m horizontal, 0.03 m – 0.05 m vertical (two sigma or 95 percent confidence), two or more redundant locations staggered at a 4-hour interval, two different bases recommended, bases are within the project envelope, each location differs from the average no more than the accuracy requirement. Discard outliers and reobserve if necessary. Base stations should use fixed height tripods. Baselines ≤ 15 KM (9 miles) Data collected at a 5-second interval for one minute (12 epochs). PDOP ≤ 3.0 , ≥ 6 satellites, position solution RMS ≤ 0.015 m. No multipath conditions observed. Rover range pole must be level before taking data. Use fixed height rover pole with bipod or tripod for stability.

Class RT3 Precisions: typically 0.04 m – 0.06 m horizontal, 0.04 m – 0.08 m vertical (two sigma or 95 percent confidence). Redundant locations not necessary for typical locations, important vertical features such as pipe inverts, structure inverts, bridge abutments, etc. should have elevations obtained from leveling or total station locations, but RT horizontal locations are

acceptable. Baselines ≤ 20 KM (12 miles) Data collected at a 1-second interval for 15 seconds (15 epochs) with a steady pole (enter attribute information before recording data). PDOP ≤ 4.0 , ≥ 5 satellites, position solution RMS ≤ 0.03 m. Minimal multipath conditions. OK to use Rover pole without bipod, try to keep pole steady and level during the location.

Class RT4 Precisions: typically 0.1 m – 0.2 m horizontal, 0.1 m – 0.3 m vertical (two sigma or 95 percent confidence). Redundant locations not necessary for typical locations. Any baseline length OK as long as the solution is fixed. Data collected at a 1-second interval for 10 seconds (10 epochs) with a steady pole, but OK to enter attributes as data is collected. PDOP ≤ 6.0 , ≥ 5 satellites, position solution RMS ≤ 0.05 m. Any environmental conditions for data collection are acceptable with the previous conditions met. Rover pole without bipod OK.

With a base station considered as coordinate “truth”, the *precisions* of the observations taken at the rover reflect the *accuracy* to this truth. That is, the precision is the measure of local accuracy. If constraints have been applied to local passive monuments, it is important that the base station be related to the localization performed. Therefore:

For Accuracy Classes RT1 and RT2:

*** If a localization has been performed, the base station must be inside the localization envelope and must be connected to the nearest localization control monument by a maximum of 1 cm + 1 ppm horizontal and 2 cm + 1 ppm vertical tolerances at the 95 percent confidence level.**

For Accuracy Classes RT3 and RT4:

***If a localization has been performed, the base station must be inside the localization envelope and should be connected to the nearest localization control monument at the accuracy level of the survey**

ACCURACY CLASS SUMMARY TABLE

	CLASS RT1	CLASS RT2	CLASS RT3	CLASS RT4
ACCURACY (TO BASE)	0.015 HORIZONTAL, 0.025 VERTICAL	0.025 HORIZONTAL, 0.04 VERTICAL	0.05 HORIZONTAL, 0.06 VERTICAL	0.15 HORIZONTAL, 0.25 VERTICAL
REDUNDANCY	≥ 2 LOCATIONS, 4-HOUR DIFFERENTIAL	≥ 2 LOCATIONS, 4-HOUR DIFFERENTIAL	NONE	NONE
BASE STATIONS	≥ 2, IN CALIBRATION PROJECT CONTROL	RECOMMEND 2 IN CALIBRATION	≥ 1, IN CALIBRATION	≥ 1, IN CALIBRATION RECOMMENDED
PDOP	≤ 2.0	≤ 3.0	≤ 4.0	≤ 6.0
RMS	≤ 0.01 M	≤ 0.015 M	≤ 0.03 M	≤ 0.05 M
COLLECTION INTERVAL	1 SECOND FOR 3-MINUTES	5 SECONDS FOR 1-MINUTE	1 SECOND FOR 15 SECONDS	1 SECOND FOR 10 SECONDS
SATELLITES	≥ 7	≥ 6	≥ 5	≥ 5
BASELINE DISTANCE	≤ 10 KM	≤ 15 KM	≤ 20 KM	ANY WITH FIXED SOLUTION
TYPICAL APPLICATIONS	PROJECT CONTROL CONSTRUCTION CONTROL POINTS CHECK ON TRAVERSE, LEVELS SCIENTIFIC STUDIES PAVING STAKE OUT	DENSIFICATION CONTROL TOPOGRAPHIC CONTROL PHOTOPOINTS UTILITY STAKE OUT	TOPOGRAPHY CROSS SECTIONS AGRICULTURE ROAD GRADING SITE GRADING	SITE GRADING WETLANDS GIS POPULATION MAPPING ENVIRONMENTAL

For Accuracy Classes requiring redundant locations, in addition to obtaining a redundant location at a staggered time, use this procedure for each location to prevent blunders:

1. Move at least 30 m from the location to create different multipath conditions, invert the rover pole antenna for 5 seconds, or temporarily disable all satellites in the data collector to force a reinitialization, then relocate the point after reverting to the proper settings.
2. Manually check the two locations to verify that the coordinates are within the accuracy desired or inverse between the locations in the data collector to view the closure between locations. (this operation can be automated in some data collectors). Each location should differ from the average by no more than the required accuracy.
3. Optionally, after losing initialization, use an “initialization on a known point” technique in the data collector. If there was a gross error in the obtained location, initialization will not occur.

4. For vertical checks, change the antenna height by a decimeter or two and relocate the point.
(Don't forget to change the rover's pole height in the data collector!)

Quick Field Summary:

- ✓ Set the base at a wide open site
- ✓ Set rover elevation mask between 10° & 15°
- ✓ The more satellites the better
- ✓ The lower the PDOP the better
- ✓ The more redundancy the better
- ✓ Beware multipath
- ✓ Beware long initialization times
- ✓ Beware antenna height blunders
- ✓ Survey with “fixed” solutions only
- ✓ Always check known points before, during and after new location sessions
- ✓ Keep equipment adjusted for highest accuracy
- ✓ Communication should be continuous while locating a point
- ✓ Precision displayed in the data collector is usually may be at the 68 percent level (or 1σ), which is only about half the error spread to get 95 percent confidence
- ✓ Have back up batteries & cables
- ✓ RT does not like tree canopy or tall buildings

VI. Further Work in the Office

RT baselines can be viewed and analyzed in most major GNSS software. The data are imported into the software with the field parameters and project configuration intact. At this point a relocalization can be done or the field localization (if any) can be reviewed and left unaltered.

*** If the site localization is changed in the office, resulting in new coordinates on all located points, the new localization information must be uploaded to the data collector before any further field work is done for that project.**

Communication between field and office is critical to coordinate integrity and consistency of the project.

***If the data are collected with covariance matrices and there is redundancy or connecting points, a post campaign adjustment can also be performed (although at typically less accuracy than with static network observations).**

The RT survey baselines can be checked by the use of generated reports or viewing each baseline graphically. See **Diagram VI-1**

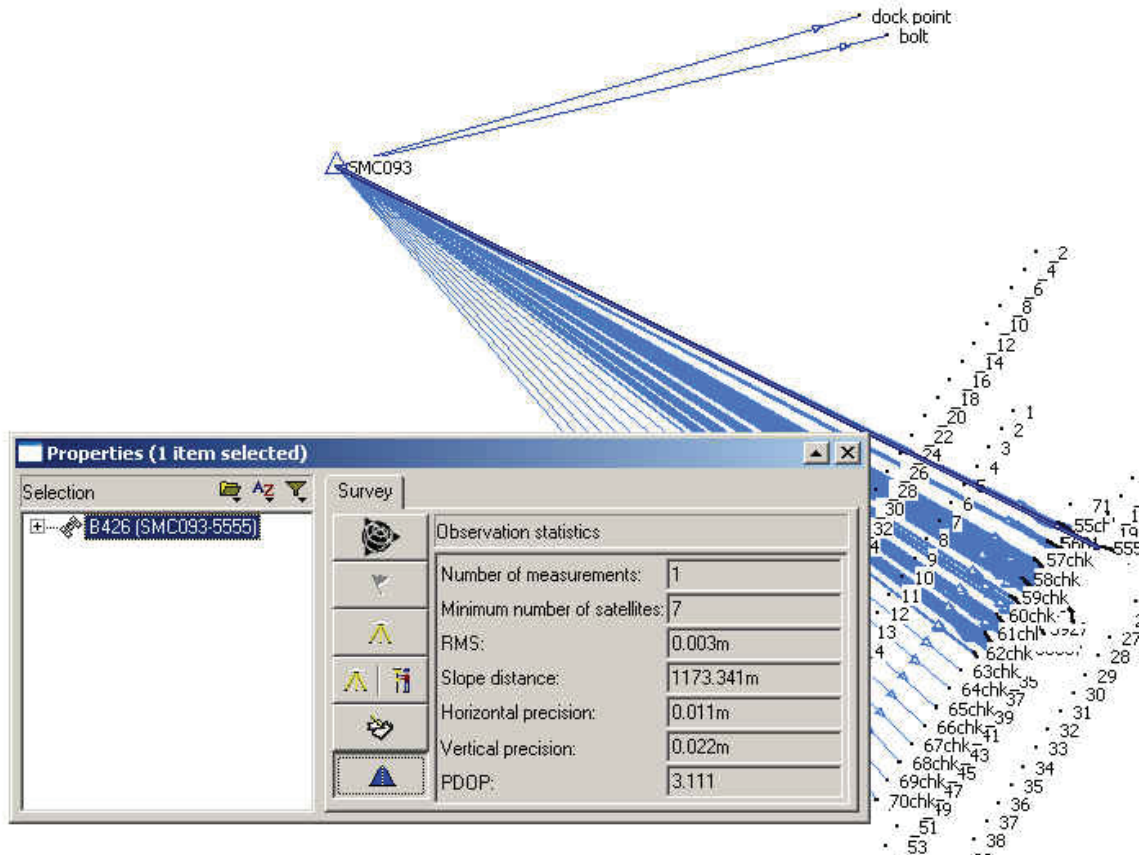

Diagram VI-1. Viewing baseline properties in the GNSS software

*** Entering in the correct coordinates of field checked stations will let the user actually adjust all the RT located points holding those known values.**

(See “Appendix A” for a case field study by the Vermont Agency of Transportation under the direction of NGS Geodetic Advisor Dan Martin).

Additional properties to office check in the RT data include:

- Antenna heights (height blunders are unacceptable and can even produce horizontal error) (Meyer, et.al, 2005).
- Antenna types
- RMS values

- Redundant observations
- Horizontal & vertical precision
- PDOP
- Base station coordinates
- Number of satellites
- Localization (if any) residuals (if calibrating horizontally, also check scale of calibration, and if using a multi-point vertical calibration, also check slope of correction surface).

A Word on Metadata

RT positioning yields coordinates from the field work performed, but little else in the way of information on the equipment used and how the work was performed. The responsible geospatial professional must put in place procedures to ensure that adequate metadata (data about data) is recorded. It is recommended that a standardized form be produced to accomplish a uniform and complete archival of pertinent information. Such data should include:

- ✓ What is the source of the data?
- ✓ What is the datum/adjustment/epoch of the base station(s)?
- ✓ What were the field conditions? Temperature, wind, precipitation, storms
- ✓ What equipment was used, especially- what antenna?
- ✓ What firmware was in the receiver & collector?
- ✓ What redundancy, if any, was used
- ✓ Were local passive monuments constrained (a localization was performed)? Horizontal? Vertical/ Both? How did the known points check? Be sure to record the date of the localization (if any) and where it was performed (field or office).
- ✓ Date, time and field technicians' names

VII. Contrast to RTN Positioning

It is important that users are aware of the different methodologies available to them for their work. With the convergence of maturing technologies such as wireless Internet communication, later generation GNSS hardware and firmware, and augmented satellite constellations, RT positioning is becoming a preferred method of data acquisition, recovery and stake out to many users in diverse fields. NGS is moving toward “active” monumentation via the CORS network and its online positioning user service (OPUS). This is a departure from the traditional delivery of precise geodetic control from passive monumentation. Currently, network solutions for RT positioning are sweeping across the United States. The cost to benefit ratio and ease of use are two main factors driving this rapid growth. As can be seen from the following list, the RTN administrators span a wide sector of all GNSS users. Some examples of the RTN administrators that are part of this rapidly expanding GNSS application are State Departments of Transportation (DOT), Value Added GNSS Vendors, GNSS Manufacturers, Spatial Reference Centers, Geodetic Surveys, Academic Institutions, Scientific Groups, County Governments, City Governments, Private Survey/Engineering Companies and Agricultural Cooperatives

Benefits to the user of an RTN over classical RT positioning include:

1. No user base station is necessary. Therefore, there are no security issues with the base, no control recovery is necessary to establish its position, and the user needs only half the equipment to produce RT work. Additionally, there is no lost time setting up and breaking down the base station equipment and radio.
2. The first order ppm error is eliminated (or drastically reduced) because ionospheric, tropospheric and orbital errors are interpolated to the site of the rover.
3. The network can be positioned to be aligned with the NSRS with high accuracy. The users will then be collecting positional data that will fit together seamlessly. This is important to all users of geospatial data, such as GIS professionals who may deal with such regional issues as emergency management and security issues.
4. Datum readjustments or changes can be done transparently to the user with no post campaign work. New datum adjustments to NAD 83 or even transformations to another geodetic reference

frame such as the International Terrestrial Reference Frame (ITRF) are done at the network level and are broadcast to the users.

5. With some business models, the user can share in the network profits by installing a network reference station and thereby getting a share of the subscription fees imposed upon other network users.

6. Different formats and accuracies are readily available. GIS data, environmental resource data, mapping grade data, etc. can be collected with one or two foot accuracy while surveyors and engineers can access the network with centimeter level accuracy. RTCM, CMR+ and other binary formats can be user selected.

7. The RTN can be quality checked and monitored in relation to the NSRS using NGS programs such as OPUS and TEQC from UNAVCO.

Drawbacks to the user of an RTN compared to classical RT positioning include:

1. Network subscription fees. These may be prohibitive for small companies.
2. Limited wireless data access.
3. Interpolation issues. Network spacing, communication and error modeling must be handled optimally.
4. Work outside the network envelope (extrapolation of corrections) degrades accuracy.
5. The network solution may not fit to local control. Localization or control network adjustments may be necessary.
6. Coordinate metadata. Is the network datum the user's required datum?
7. Can all GNSS manufacturers' equipment be used and will different gear produce the same results?
8. Will overlapping RTN produce homogenous coordinates?

NGS has an important role to play in this new positioning solution, both in providing support for these networks as well as protecting the public interest. In addition, NGS plans to encourage RTN to successfully align to the NSRS within a certain tolerance (to be determined) by connections to the CORS network. Following this document, NGS will develop user guidelines and administrative guidelines for RTN in the effort to keep the produced positions homogenous and accurate for all levels of geospatial professionals.

VIII. Best Methods Summary

The following are taken from the highlighted, underlined or otherwise summarized recommendations found throughout the document. It is felt that an easily printable composite of the best methods would provide a very useable guide for quick reference. However, for the proper knowledge of the many variables and influences on accurate RT positioning, the background information throughout the document should be digested to help the user collect reliable data.

- RT positioning of important data points can not be done reliably without some form of redundancy.
- Redundancy is critical for important point positions using RT
- Regardless of the type of external battery used, it should supply at least 12 volts and should be fully charged. An underpowered battery can severely limit communication range
- The base broadcast radio antenna should be raised to the maximum height possible.
- Rather than communicating with a dynamic address as is the case in many internet scenarios, static IP addresses provide a reliable connection and are the recommended communication link configuration.
- Adjust the base and rover circular level vial before every campaign.
- As a good practice or if the circular level vial is not adjusted, it is still possible to eliminate the possible plumbing error by taking two observations on a point with the rover pole rotated 180° between each location.
- Clock and hardware errors are eliminated with differencing, while some modeling can be done for the Ionospheric and Tropospheric errors. Generally, the conditions are considered to cancel as they are relative to both base and rover receivers. Note: 1 nanosecond of time error translates to 30 cm in range error
- It is possible to perform an accurate RT session from an autonomous-positioned base station point if the correct position can be introduced to the project in the data collector or in the office software later.
- In fact, it is much better to establish a new, completely open sky view site for the base than it is to try to occupy an existing reliable, well known monument with a somewhat obscured sky view.

During an interval encompassing the solar maximum, users can expect inability to initialize, loss of satellite communications, loss of wireless connections and radio blackouts, perhaps in random areas and time spans.

<http://www.sec.noaa.gov/NOAAscales/index.html#SolarRadiationStorms>

Recommendations: Do not try to perform RT during level G3 – G5 storm events.

Recommendations: Do not try to perform RT during level S4 – S5 storm events.

Recommendations: Do not try to perform RT during level R3 – R5 storm events. Be aware of possible radio problems at level R2 storm events.

-
- Unlike networked solutions for RT positioning, in classical (single-base) RT positioning there is minimal atmospheric modeling because it is assumed that both the base station and the rover are experiencing nearly identical atmospheric conditions.
 - The single most important guideline to remember about the weather with RT positioning is to never perform RT in obviously different conditions from base to rover.
 - It is helpful to partially mitigate the worst effects of atmospheric delay and refraction by setting an elevation mask(cut off angle) of 10°- 15° to block the lower satellites signals which have the longest run through the atmosphere. A 10° mask is recommended.
 - The actual data collection or point stake out is displayed in the data collector based on a system precision which shows the spread of the results (RMS) at a certain confidence level and the calculated 2-D and height (horizontal and vertical) solution relative to the base station in the user's reference frame.
 - Therefore, to get a sense of the accuracy achieved, it is recommended that the user's survey be based on proven control monumentation with a high degree of integrity, the data precision is monitored as the work proceeds, points with known values are checked before, during and after each RT session, and redundant locations are taken on each important point.
 - When viewing the RMS on the data collector screen, the user should be aware of the confidence level. Some displays show a 68% confidence for the horizontal and vertical precision.
 - Areas with probable multipath conditions should not be used for RT positioned control sites -especially not for a base station position. These sites include locations under or very near tree canopy, structures within 30 m that are over the height of the antenna, nearby vehicles and nearby metal objects, abutting large water bodies, and nearby signs.
 - RT localizations allow the user to transform the coordinates of the control monumentation positioned with their RT-derived positions in the WGS 84 datum, to the

user datum (even if it's assumed) as realized by the user's coordinates on the monuments.

- To have confidence in a site localization, the project site must be surrounded by at least 4 trusted vertical control monuments and 4 trusted horizontal control monuments which to the greatest extent possible, form a rectangle.
- It is critical that all project work is done using the same correct and verified calibration. Different calibrations can result in substantially different position coordinates
If the site localization is changed in the office, resulting in new coordinates on all located points, the new localization information must be uploaded to the data collector before any further field work is done for that project. The user must be aware of the solution state and should wait until the solution is displayed as fixed before taking RT observations
- For best vertical results, it is recommended to apply the current hybrid geoid model in addition to a localization to the vertical control.
- To collect important positional data, the communication link should be continuous and the GNSS solution should become fixed in a 'normal' amount of time and should remain fixed for the duration of the data collection at the point.
- To collect important positional data, the communication link should be continuous and the GNSS solution should become fixed in a 'normal' amount of time and should remain fixed for the duration of the data collection at the point.
- Before beginning new point data collection, a check shot should always be taken on a known point.
- To collect important positional data, known and trusted points should be checked with the same initialization as subsequent points to be collected.
- It is important to know what accuracy is needed before performing the RT field work.

ACCURACY CLASS SUMMARY TABLE

	CLASS RT1	CLASS RT2	CLASS RT3	CLASS RT4
ACCURACY (TO BASE)	0.015 HORIZONTAL, 0.025 VERTICAL	0.025 HORIZONTAL, 0.04 VERTICAL	0.05 HORIZONTAL, 0.06 VERTICAL	0.15 HORIZONTAL, 0.25 VERTICAL
REDUNDANCY	≥ 2 LOCATIONS, 4-HOUR DIFFERENTIAL	≥ 2 LOCATIONS, 4-HOUR DIFFERENTIAL	NONE	NONE
BASE STATIONS	≥ 2, IN CALIBRATION PROJECT CONTROL	RECOMMEND 2 IN CALIBRATION	≥ 1, IN CALIBRATION	≥ 1, IN CALIBRATION RECOMMENDED
PDOP	≤ 2.0	≤ 3.0	≤ 4.0	≤ 6.0
RMS	≤ 0.01 M	≤ 0.015 M	≤ 0.03 M	≤ 0.05 M
COLLECTION INTERVAL	1 SECOND FOR 3-MINUTES	5 SECONDS FOR 1-MINUTE	1 SECOND FOR 15 SECONDS	1 SECOND FOR 10 SECONDS
SATELLITES	≥ 7	≥ 6	≥ 5	≥ 5
BASELINE DISTANCE	≤ 10 KM	≤ 15 KM	≤ 20 KM	ANY WITH FIXED SOLUTION
TYPICAL APPLICATIONS	PROJECT CONTROL CONSTRUCTION CONTROL POINTS CHECK ON TRAVERSE, LEVELS SCIENTIFIC STUDIES PAVING STAKE OUT	DENSIFICATION CONTROL TOPOGRAPHIC CONTROL PHOTOPOINTS UTILITY STAKE OUT	TOPOGRAPHY CROSS SECTIONS AGRICULTURE ROAD GRADING SITE GRADING	SITE GRADING WETLANDS GIS POPULATION MAPPING ENVIRONMENTAL

For Accuracy Classes RT1 and RT2:

If a calibration has been performed, the base station must be inside the calibration envelope and must be connected to the nearest calibration control monument by a maximum of 1 cm + 1 ppm horizontal and 2 cm + 1 ppm vertical tolerances at the 95 percent confidence level.

For Accuracy Classes RT3 and RT4:

If a calibration has been performed, the base station must be inside the calibration envelope and should be connected to the nearest calibration control monument at the accuracy level of the survey

→ If the data are collected with covariance matrices and there is redundancy or connecting points, a post campaign adjustment can also be performed (although at typically less accuracy than with static network observations).

→ The following are all terms that must be understood and/or monitored by RTK field technicians: Look for these terms and concepts in the guidelines. Knowledge of these is necessary for expertise at the rover:

- DOP varieties
- Multipath
- Baseline RMS
- Number of satellites
- Elevation mask (or cut-off angle)
- Base accuracy- datum level, local level
- Base security
- Redundancy, redundancy, redundancy
- PPM – iono, tropo models, orbit errors
- Space weather- ‘G’, ‘S’, ‘R’ levels
- Geoid quality
- Constraining passive monuments
- Bubble adjustment
- Latency, update rate
- Fixed and float solutions
- Accuracy versus Precision
- Signal to Noise Ratio (S/N or C/N₀)

- Elevation Mask
- Geoid Model
- Part Per Million (PPM) Error
- UHF, spread spectrum Radio Communication
- CDMA/SIM/Cellular TCP/IP Communication

→ Additionally, the following are concepts that should be understood. Please see the RT positioning glossary (herein) for brief definitions:

Carrier Phase/Code Phase

WGS 84, ITRS versus NAD 83

GPS and GLONASS Constellations

→ RT positioning yields coordinates from the field work performed, but little else in the way of information on the equipment used and how the work was performed. The responsible geospatial professional must put in place procedures to ensure that adequate metadata (data about data) is recorded.

→ Quick Field Summary:

- Set the base at a wide open site
- Set rover elevation mask between 10° & 15°
- The more satellites the better
- The lower the PDOP the better
- The more redundancy the better
- Beware multipath
- Beware long initialization times
- Beware antenna height blunders
- Survey with “fixed” solutions only
- Always check known points before, during and after new location sessions
- Keep equipment adjusted for highest accuracy
- Communication should be continuous while locating a point
- Know the precision displayed in the data collector- it might be at the 68 percent level (or one sigma), which is only about half the error spread to get 95 percent confidence
- Have back up batteries & cables
- RT doesn't like tree canopy or tall buildings

Links:

USCG NANU: <http://cglis.uscg.mil/mailman/listinfo/nanu>

SWPC: <http://www.swpc.noaa.gov/>

IX. Classical Real Time Positioning Glossary

Note: The definitions of the terms found below are adapted to fit the area of real time positioning and are not meant to be a rigorous, fully complete definition as found in the NGS Geodetic Glossary.

See: http://www.ngs.noaa.gov/CORS-Proxy/Glossary/xml/NGS_Glossary.xml

-A-

Autonomous Positioning

A single receiver position relative to a GNSS datum as realized by the satellites. No additional error modeling is done beyond broadcast models. A current civil user can expect better than 10 m accuracy under normal conditions autonomously.

Accuracy

The degree to which a particular RT point location measurement relates to the “truth”. In classical RT this is defined by the horizontal and/or vertical positional error ellipse (or covariance matrix) at 95 percent (2σ) confidence level directly related to the base station as the representative of the datum. The base accuracy should always be known relative to the project datum.

Acquisition

The process of locking onto a satellite's available C/A and P code. A receiver acquires all available satellites when it is first powered up, then acquires additional satellites as they become available and continues tracking them until they become unavailable.

Algorithm

A special, logical method used to solve a certain type of mathematical problem. A set of programmed instructions to obtain an end result.

Almanac

A data file that contains the approximate orbit information of all satellites, which is transmitted by each satellite within its Navigation Message every 12.5 minutes (GPS). It is transmitted from the satellite to a receiver, where it facilitates rapid satellite signal acquisition within the receivers by providing the receiver

an approximate search area to acquire the satellite's signals. Almanac data is kept current within a receiver to facilitate "hot starts" by permitting the Doppler Shift of each satellite signal to be determined and configuring each tracking channel for this Doppler-shifted carrier frequency. Doppler can detect cycle slips by tracking the path of the satellite relative to the receiver's antenna.

Ambiguity / Ambiguity Resolution

Carrier phase measurements are made in relation to a cycle or wavelength of the L_1 or L_2 carrier waves. While the receiver can tag the partial cycle after locking on to a satellite, it can not directly know the whole number of cycles preceding that tag. This "ambiguity" of whole cycles must be solved in order to correctly calculate the distance from the satellite. The process or algorithm for determining the value for the ambiguities is "Ambiguity Resolution". This can be done while the rover is moving which is known as "on the fly" AR (which requires dual frequency receiver capabilities). The number of cycles is different for each frequency to each satellite at each epoch. Once the ambiguity is removed using double differencing and other techniques, the initial count of the number of cycles can be maintained and differential positioning can be achieved by tracking the difference in cycles at the rover. Precisions by using the carrier phase can reach the millimeter level. Each sine wave length of the L_1 frequency is 19.4 cm and that of the L_2 is 24.2 cm. If there is signal obstruction or loss of communication, a "cycle slip" occurs, causing the new ambiguity after the cycle slip to be different from the value before. Cycle slip repair restores the continuity of carrier cycle counts and ensures that there is only one ambiguity for each satellite-receiver pair. Repair is aided through triple differencing and also Doppler tracking.

Antenna, GNSS

That part of the GNSS receiver hardware which receives and sometimes amplifies the incoming L-Band signals. Antennas vary in shape and size, but most these days use so-called "microstrip" or "patch" antenna elements. The base station should employ a ground plane antenna to help mitigate multipath. Fixed reference stations frequently use a "choke-ring" geodetic antenna to mitigate multipath signals.

Antenna Phase Center

The electrical point, within or outside an antenna, at which the GNSS signal is measured. The realization of the phase center is determined by the set of antenna phase center variations (PCV) corrections that have been defined/adopted by NGS to account for the nonideal electrical response as a function of elevation and azimuth angles. The L_1 and L_2 phase centers are not identical. Traditionally, the NGS has modeled the phase center based on a relative variation from an antenna used as the reference. Current technology enables absolute phase center modeling to be performed rather than being relative to another antenna.

Antenna Reference Point

The point on the exterior of the antenna to which NGS references the antenna phase center position. It is usually the bottom of the antenna mount. Most RT firmware will use this height input to compute the actual modeled phase center using PCV models from the NGS or other sources.

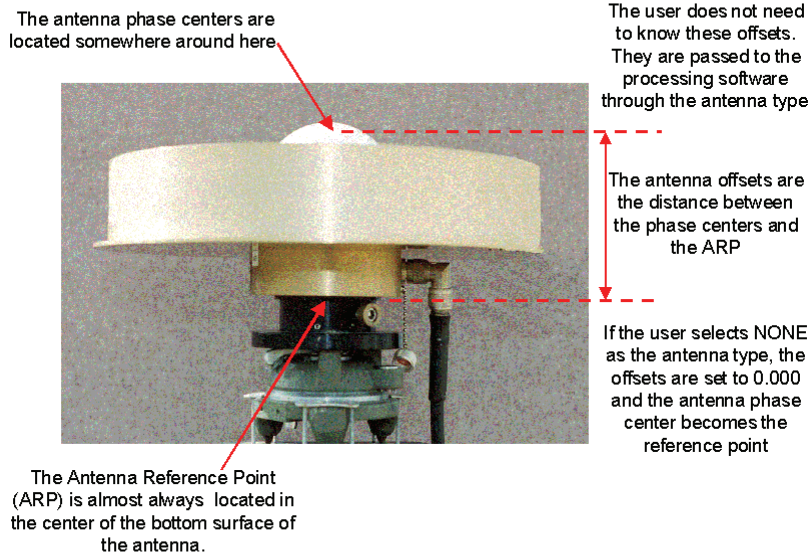

Antenna Splitter

An attachment which can be used to split the antenna signal, so that it may be fed to two GNSS receivers. Such a configuration forms the basis of a Zero Baseline test.

Anti-Spoofing (AS)

Is a policy of the DoD by which the GPS P-Code is encrypted (by the additional modulation of a so-called W-Code to generate a new "Y-Code"), to protect the militarily important P-Code signals from being "spoofed" through the transmission of false GPS signals by an adversary during times of war. Hence civilian GPS receivers are unable to make direct P-Code pseudo-range measurements and must use proprietary (indirect) signal tracking techniques to make measurements on the L_2 carrier wave (for both pseudo-range and carrier phase). All dual-frequency instrumentation must therefore overcome AS using these special signal tracking and measurement techniques. AS applies to the GPS constellation only.

Attribute

A characteristic which describes a feature (a point, line or polygon). Attributes are part of the data fields linked to the geospatial location of the Feature. Typically it is associated with geospatial data gathering for inclusion within Geographic Information Systems (GIS).

- B -

Baseline

A Baseline is a computed 3-D vector for a pair of stations for which simultaneous GPS data have been collected. It is mathematically expressed as a vector of Cartesian Earth Centered Earth Fixed (ECEF) X,Y,Z coordinate differences between the base or reference station and the rover or unknown station.

Base Station

Also called a Reference Station. In GNSS RT positioning, this is a receiver that is set up on a known location (at whatever accuracy) specifically to collect data for differentially correcting data files of the rover receiver. In the case of pseudo-range-based Differential GNSS (DGPS) the base station calculates the error for each satellite and, through differential correction, improves the accuracy of GNSS positions collected at the rover receiver. For GNSS RT Surveying techniques, the receiver data from the base station is combined with the data from the other receiver to form double-differenced observations, from which the baseline vector is determined.

Bias

All GNSS signals are affected by biases and errors. Biases are systematic errors that cause the observed measurements to be different from truth by a predictable or systematic amount, such as the lengthening of the signal path due to tropospheric refraction. Biases must somehow be accounted for in the data processing if high accuracy is sought. In classical RT positioning, many of the biases are treated as the same at the base station and the rover. Unmodeled biases such as multipath are outliers in the observables contributing to the position solution. One nanosecond of time delay is equivalent to 30 cm in range error.

Blunder

A gross error that prevents the desired position accuracy from being achieved. As opposed to *systematic errors*, such as a mal-adjusted circular vial level at the base station, or *random errors* that are typically mitigated through least squares techniques, blunders might be using the wrong antenna height, or recording a float solution before the solution becomes initialized.

Broadcast Ephemerides

The orbital position sent in the navigation message based on the predicted position of the satellite, as updated every two hours by the ground control, and accurate to around 2.7 m. Therefore, the satellites will travel around 30,000 km (18,641 miles) between orbit updates. This is the orbit information used in all RT surveys. While broadcast orbits are the most inaccurate orbital information available, they have little effect on short baselines (only 1 mm for 10 km). In order of ascending accuracy, the ultra rapid orbits are available after approximately 6 hours, the rapid orbits are available after 13-hours and the final post-fit precise orbits are available after about 10 days.

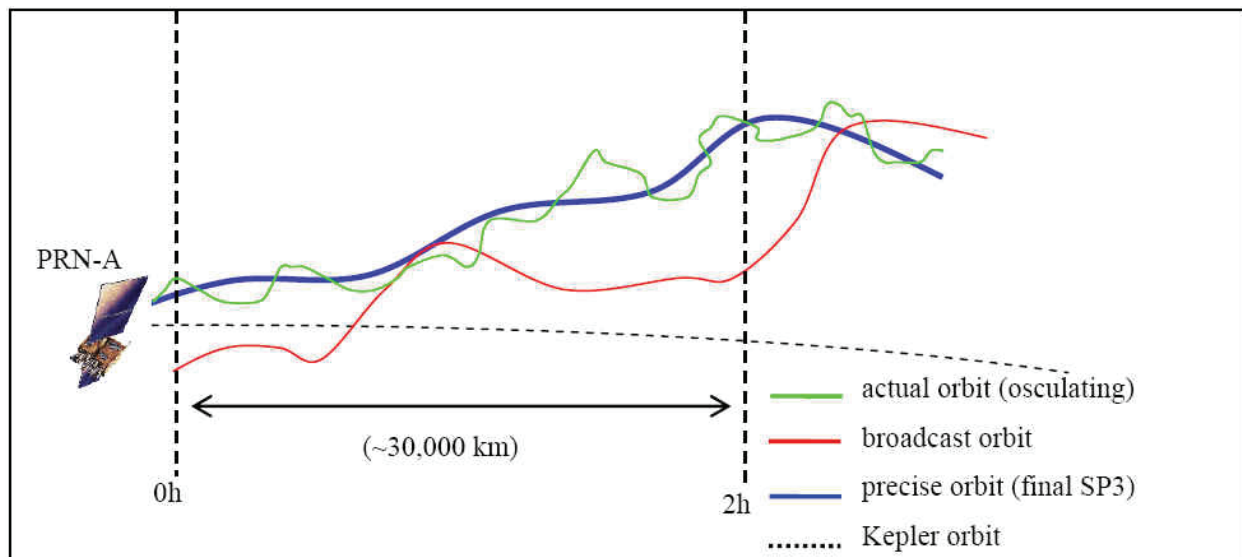

(Graphic: Ahn, 2005)

- C -

C/A-Code

Coarse Acquisition or Clear Acquisition code. It is the standard GPS PRN code, also known as the Civilian Code or S-Code. It is only modulated on the L_1 carrier and it is used to acquire and decode the L_1 satellite signals so that L_1 pseudo-range measurements can be made (the Block IIR-M satellites add another civil code on the L_2 frequency). GPS receivers internally generate the PRN string of bit code of for each GPS satellite and align the code to lock on to each signal. The 1.023 MHz chip C/A code repeats every 1 ms giving a code chip length of 300 m which, is very easy to lock onto.

Calibration (a.k.a. Localization), Site

In a horizontal coordinate sense, it is the transformation of the projected GNSS ECEF WGS 84 coordinates realized by the satellites to project specific planar grid coordinates. Typically, the project area is calibrated by occupying several monuments outside of the project's perimeter to record GNSS positions. The local planar grid coordinates for these monuments are imported or entered into the database. Data collector firmware then can perform a four parameter rotation, translation and scale to enable an unweighted least squares adjusted solution. This best fit solution can be viewed and the residuals at each calibration point reviewed. In addition, the scale of the horizontal calibration and the slope of the (multi-point) vertical calibration should be checked to ensure they are realistic and reasonable. A vertical calibration is performed similarly, and can be used to convert WGS 84 ellipsoid heights to "elevations", either with or without a geoid model. The vertical calibration may be a simple vertical shift to match a single elevation, or can be a best-fit planar correction surface computed using least-squares. The user then must decide which, if any, monuments to reject in horizontal and/or vertical components. Once readjustments or additional occupations are completed and the calibration is accepted, the project work is then done henceforth using the calibration. Care must be exercised to prevent different calibrations from being used on the same project, as the calibration can also be done in the office software and (possibly) uploaded to the field data collector. Calibrations, when used, should be done carefully by a qualified geospatial professional to correctly assess local control and eliminate outliers.

Carrier Phase Measurements

By using the wave lengths of the two GNSS frequencies, ≈ 19 cm for L_1 and ≈ 24 cm for L_2 , precise positioning can be accomplished. By tagging the partial wave length at the time of lock on the satellites, it is theoretically possible to resolve a position to a few millimeters if the whole number of wave lengths from each satellite on each frequency is known to translate the total into a distance. By using frequency combinations and *Differencing* techniques, iterative least squares adjustments can produce a best set of integer numbers and centimeter level positioning can commence. This is known as a *fixed solution*. Once

the receiver is tracking the satellites with a fixed solution, the continuous count of the integer number of cycles correctly shows the change in range seen by the receiver. If the receiver loses lock on the satellites the count is lost and the solution will be seen to jump an arbitrary number of cycles, known as a *cycle slip*. This can be determined by the triple difference solution.

Carrier

The steady transmitted RF signal whose amplitude, frequency, or phase is modulated to carry information. In the case of GPS there are two transmitted L-band carrier waves: (a) L_1 at 1575.42 MHz, and (b) L_2 at 1227.60 MHz, phase modulated by the Navigation Message (both L_1 and L_2), the P-Code (both L_1 and L_2) and the C/A-Code (L_1) and added civil code on (L_2). Future constellation enhancements starting with the Block II F satellites, will introduce a third civil frequency, L_5 , at 1176.45 MHz.

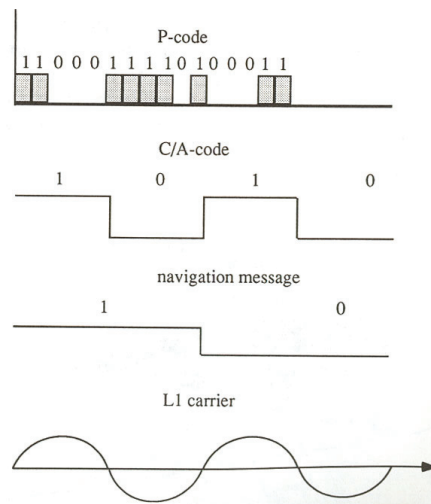

Carrier Phase Ambiguity

The unknown number of integer carrier phase cycles (or wave lengths) between the user and the satellite at the start of tracking.

Circular Error Probable (CEP)

A statistical measure of the horizontal precision. The CEP value is defined as a circle's radius, when centered at the true position, encloses 50 percent of the data points in a horizontal scatter plot. Thus, half the data points are within a 2-D CEP circle and half are outside the circle.

Clock Bias

The difference between the receiver or satellite clock's indicated time and a well-defined time scale reference such as UTC (Coordinated Universal Time), TAI (International Atomic Time) or GPST (GPS Time). Also can refer to the clock offset of a receiver relative to a satellite's clock.

Code Division Multiple Access (CDMA)

A method whereby many radios use the same frequency, but each one has a unique code. CDMA data modems are used with static internet IP addresses to extend the range of RT positioning to several tens of kilometers. GPS uses CDMA techniques with codes for their unique cross-correlation properties. GLONASS, on the other hand, uses Frequency Division Multiple Access (FDMA), where each satellite has the same codes but different frequencies.

Code Phase

GPS measurements based on the C/A-Code. The term is sometimes restricted to the C/A- or P-Code pseudo-range measurement when expressed in units of cycles.

Constellation

Refers to either the specific set of satellites used in calculating a position, or all the satellites visible to a GNSS receiver at one time.

Control Point

Also called a control station or geodetic control station. A monumented point to which coordinates have been assigned by the use of terrestrial or satellite surveying techniques. The coordinates may be expressed in terms of a satellite reference coordinate system (such as WGS 84, or PZ 90), or a local geodetic datum. The official geodetic national horizontal datum for the United States is NAD 83 and the official vertical datum is NAVD 88.

Cut-off Angle

The minimum acceptable satellite elevation angle (above the horizon) to avoid the most noise in the GNSS signals due to atmospheric delay and refraction or possibly multipath conditions. Typically, cut off angles are set between 10° and 15° for RT surveying. Also called *Elevation Mask*.

Cycle Slip

A discontinuity of an integer number of cycles in the carrier phase count resulting from a loss of lock in the tracking loop of a GPS receiver. This corrupts the carrier phase measurement, causing the unknown Ambiguity value to be different after the cycle slip compared with its value before the slip. It requires a reinitialization of the receiver to repair the slip of the unknown number of "missing" cycles and the RT observations corrected by that amount.

Covariance (Matrix)

A measure of the correlation of errors between two observations or derived quantities. Also refers to an off-diagonal term in a variance-covariance matrix.

A covariance matrix is a matrix that defines the variance and covariance of an observation. The elements of the diagonal are the variance and all elements on either side of the diagonal are the covariance. Graphically, this matrix can define an error ellipse (or ellipsoid) for the baseline or point position.

- D -

Data Collector

Also known as a data logger or data recorder. A handheld, relatively lightweight data entry computer, usually ruggedized. It stores the RT data collected in the field. In static GNSS surveying, the receiver is typically the repository for the data unless directed elsewhere. Also, it can be used to store additional data obtained by a GNSS receiver, such as Attribute information on a Feature whose coordinates are captured for a GIS project. Most collectors have coordinate geometry capability as well as the ability to perform localizations, set elevation masks, block satellites, view satellite positions, change datums and units in the display. Modern data collectors are frequently touch screen capable and internet capable.

Datum (Geodetic)

Simply stated, a geodetic datum is defined by a reference surface, an origin, an orientation, gravity and a scale. For example, the NAD 83 datum is defined by the Geodetic Reference System 1980 (GRS 80) ellipsoid, at an origin near the center of the mass of the earth, with axes oriented through the pole, equator and at right angles, with a scale unit based on the international meter. The realization of the datum is through monumentation of some sort on, above or below the earth. The realization of WGS 84 is the GPS satellites themselves along with the ground control segment. We access WGS 84 through the satellites. All RT work is done in this datum and transformed by seven parameters (shifts X,Y,Z, rotations X,Y,Z and scale) to, for example, the displayed datum projection we view in the data collector. The elevations are obtained through a transformation from WGS 84 ellipsoid heights to NAD 83 ellipsoid heights where the geoid model can be applied to yield NAVD 88 orthometric heights. Alternatively, site localizations create an inclined plane (that could be used with the geoid model as well) that is the result of the transformation of the RT WGS 84 positions to local control monumentation coordinates. (see *Localization*).

Differential GPS (DGPS)

A code based technique to improve GPS accuracy (but not as accurately as carrier phase positioning) that uses computed pseudo-range errors measured at a known base station location to improve the measurements made by other GPS receivers within the same general geographic area. It may be implemented in RT through the provision of a communication link between the GPS receivers, transmitting the correction information in the industry-standard RTCM format, or various proprietary formats. It may be implemented in single-base station mode, in the so-called Local Area DGPS (LADGPS), or using a network of base stations, as in the Wide Area DGPS (WADGPS) implementation.

Differential Positioning

Also known as relative positioning. Precise measurement of the relative positions of two receivers tracking the same GNSS signals. Usually associated with code based GPS positioning, but may be considered terminology for the more precise carrier phase-based baseline determination technique associated with GNSS Surveying.

Dilution of Precision (DOP)

An indicator of the effect of satellite geometry on positioning errors. Positions derived with a higher DOP value generally yield less accurate measurements than those derived with lower DOP. There are a variety

of DOP indicators, such as GDOP (Geometric DOP), PDOP (Position DOP), HDOP (Horizontal DOP), VDOP (Vertical DOP), etc.

GDOP

Uncertainty of all parameters (latitude, longitude, height, clock offset)

PDOP

Uncertainty of 3D parameters (latitude, longitude, height). This is the measure most frequently used as a guide in RT positioning. It is a unitless figure of merit expressing the relationship between the error in user position and the error in satellite position, which is a function of the configuration of satellites from which signals are derived in positioning. Geometrically, PDOP is proportional to 1 divided by the volume of the polyhedron formed by lines running from the receiver to the observed satellites. Small values, such as "2", are good for positioning while higher values produce less accurate position solutions. Small PDOP is associated with widely separated satellites. The UERE multiplied by the PDOP would give the expected, uncorrected position error.

HDOP

Uncertainty of 2D parameters (latitude, longitude)

VDOP

Uncertainty of height parameter

TDOP

Uncertainty of clock offset parameter

Doppler Shift

The apparent change in the frequency of a signal caused by the relative motion of the satellite and receiver. This can be used to detect cycle slips.

Double-Difference

A data processing procedure by which the pseudo-range or carrier phase measurements made simultaneously by two GNSS receivers are combined (differenced) so that, for any measurement epoch, the observations from one receiver to two satellites are subtracted from each other to remove that

receiver's clock error (or bias) and hardware error. Two receivers to one satellite eliminate that satellite's clock errors and hardware errors. The difference of these two single differences is then the double difference. It also significantly reduces the effect of unmodeled atmospheric biases and orbit errors. The resulting set of Double-Differenced observables (for all independent combinations of two-satellite-two-receiver combinations) can be processed to solve for the baseline (linking the two receivers) components and, in the case of ambiguous (unknown) carrier phase measurements, the integer ambiguity parameters. All high precision positioning techniques use some form of Double-Difference processing: pseudo-range, unambiguous carrier phase "fixed" solution (i.e., after the double-differenced ambiguity values have been estimated and applied to the original carrier measurements), or ambiguous carrier phase data within a "free" solution. See Appendix B for a graphic explanation.

Dual-Frequency

Refers to the instrumentation that can make measurements on both GPS L-Band frequencies, or to the measurements themselves (e.g., L_1 and L_2 pseudo-range or carrier phase measurements). Dual-frequency measurements are useful for high precision RT because the Ionospheric Delay bias can be determined, and the data corrected for it. In the case of Double-Differenced carrier phase, dual-frequency observations can account for the residual ionospheric bias (for case of long baselines), and aid in Ambiguity Resolution. All "top-of-the-line" GPS receivers are of the dual-frequency variety, and are comparatively expensive because of the special signal processing techniques that must be implemented to make measurements on the L_2 carrier under the policy of AS. RT positioning can be done with L_1 , but only with limited range and without on-the-fly initialization capability.

- E -

Earth-Centered, Earth-Fixed (ECEF) Coordinates

A reference to a (X, Y, Z) three-dimensional Cartesian coordinate frame attached to the Earth's mantle, at certain epoch t , and the following definitions:

1. Origin: At the geocenter (Earth's center of mass including atmosphere and oceans)
2. Z-axis: Directed toward the conventional definition of the North Pole, or more precise, towards the Conventional Terrestrial Pole (CTP) as defined by the International Earth Rotation Service (IERS). (Approximately coincides with the Mean Pole of rotation).

3. X-axis: Passes through the point of zero longitude (approximately on the Greenwich meridian), as defined by the IERS, and the semi-major axis of the datum ellipsoid.

4. Y-axis: Forms a right-handed coordinate system with the X- and Z-axes.

There are many realizations of this ideal ECEF frame frequently used by the geodetic-surveying community (e.g. ITRF97, ITRF2000, ITRF2005, WGS 84, etc.). The scale along the three Cartesian axes are given in linear units based on the modern definition of the international unit of length (the meter) = the distance traveled by light in a vacuum in $1/299,792,458$ of a second.

The orbits of the GNSS satellite constellations are given in different ECEF frames and the user should be aware that the differences between them may be negligible or, to the contrary, appropriate transformations between frames must be implemented. This process is generally performed by the internal receiver software that gives the final results a pre-specified ECEF coordinate frame.

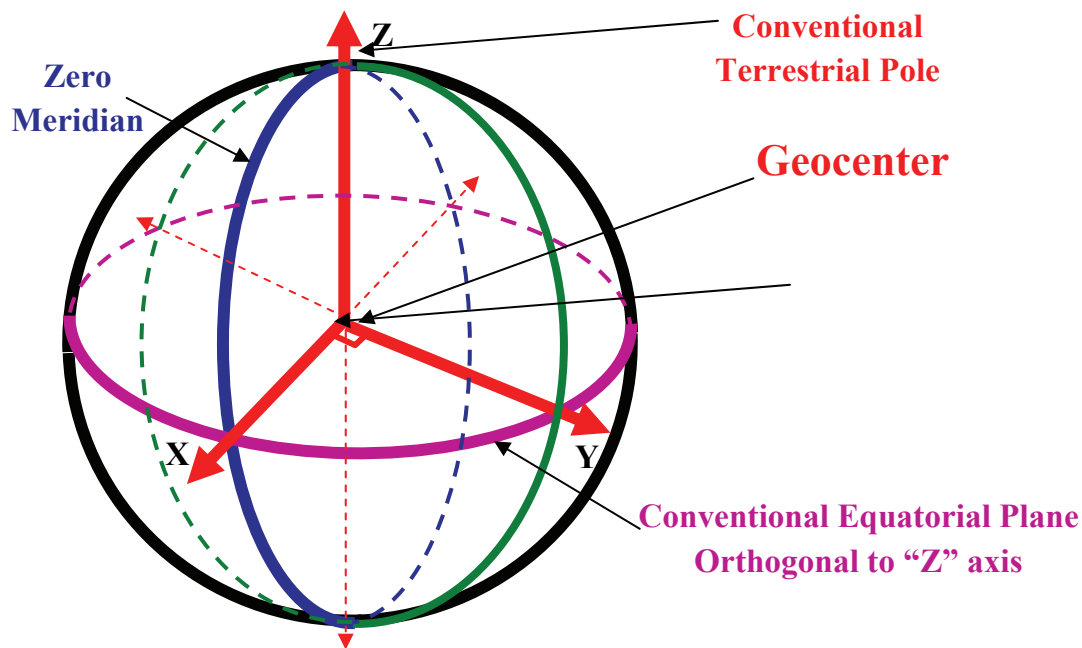

Elevation Mask

See Cut-Off Angle.

Ellipsoid Height (See Height, Ellipsoid)

Ephemeris (Ephemerides)

The file of values giving a particular satellite's position and velocity at any instant in time. The Broadcast Ephemeris for a satellite is the prediction of the current satellite position and velocity determined by the Master Control Station, uploaded by the Control Segment to the GPS satellites, and transmitted to the user receiver in the Data Message. The Precise Ephemerides are post-processed values derived by, for example, the International GNSS Service (IGS), and available to users post-mission via the Internet. Broadcast Ephemeris data is sufficient for short baseline RTK work, i.e. for baselines under 30 Km. Ephemeris errors are largely mitigated by double-differenced observables from carrier phase measurements when the receivers are up to a few tens of kilometers apart. Broadcast Ephemeris errors are typically around 2.7 m, while Precise Ephemeris errors are at the 1-2 cm level.

Epoch

A specific instant in time. RT GPS carrier phase measurements are made at a given interval (e.g. every 1 second) or epoch rate.

Error ellipse

A statistical measure of the horizontal positional error at a given point computed from the propagation of all errors contributing to the position, shown graphically in the GNSS software. Most modern GNSS receivers and data collector firmware can generate and save the position covariance matrix RT mode to import into software. Redundant and connected baselines can then be adjusted and error statistics generated. This is an excellent method to analyze the integrity of RTK results. An error ellipsoid can also be computed to display the 3D positional error, but this is rarely done because it is more difficult to visualize.

- F -

Federal Radionavigation Plan (FRP)

Congressionally mandated, joint DoD and US Department of Transportation (Dot) effort to reduce the proliferation and overlap of federally funded radionavigation systems. The FRP is designed to delineate policies and plans for US government-provided radionavigation services. Produced annually.

Fixed Ambiguity Estimates

Carrier phase ambiguity estimates which are set to a given number and held constant. Usually they are set to integers or values derived from linear combinations of integers. In an iterative, least squares process, the receiver performs algorithms to resolve the integer number of initial epoch wave lengths or cycles to each satellite on each frequency. The resolution of this ambiguity is necessary to perform differential carrier phase positioning. Once these are resolved, the ambiguities are said to be “fixed”.

Float Ambiguity

The estimated number of cycles and partial (decimal) cycles to each satellite on each frequency. The float ambiguity estimates are iterated through algorithms to produce a solution for the whole cycle count necessary to achieve centimeter level RT differential positioning. Float ambiguities are sometimes the only solution possible for long baselines (100+ km), but are considered adequate at those distances.

Frequency

The number of waves passing a specific point within a unit period of time, expressed in Hertz (cycles per second). E.g., the L₁ frequency is 1.57542 million cycles per second or 1575.42 MHz.

Frequency Modulation (FM)

A method of encoding information in a carrier signal by altering the frequency while amplitude remains constant. The GPS carrier frequencies are modulated with the C/A code, P-code and navigation message.

Galileo

The European Union's satellite navigation system. Projected to be operational after 2010.

Geodetic Survey

Surveys for the establishment of control networks (comprised of active or passive Reference or Control Points), which are the basis for accurate positioning and navigation under, on or over the surface of the earth. May be carried out using either terrestrial or satellite positioning (e.g. GPS) techniques. "Geodetic" surveys imply that refraction, curvature of the earth, atmospheric conditions and gravity are taken into account in the measurements rather than "plane" surveys in which these factors are generally ignored. The outcome is a network of stations which are a physical realization of the Geodetic Datum or Reference System.

Geographic Information System (GIS)

A computer-based system that is capable of collecting, managing and analyzing geospatial data. It includes the networking systems, personnel, software, hardware and communication media to integrate the data. Generally speaking, it is a tabular database hot-linked to a graphical display of points, lines and polygons. Layers of data types of many different accuracies are represented separately or together. It has the ability to provide answers to data queries and can perform spatial analysis topologies from graphical and tabular data. RT techniques are frequently used with many facets of GIS, such as populating a utility infrastructure or locating photopoints for photogrammetric applications.

Geoid (Gravimetric), Geoid (Hybrid)

The equipotential surface (homogenous gravitational acceleration value) that most closely approximates global Mean Sea Level. Local mean sea level diverges from this surface due to factors such as constant winds, currents, salinity, etc. A conversion surface is applied to the Gravimetric Geoid (e.g., USGG 2009) to obtain the Hybrid Geoid Model (e.g., Geoid 09) which is used to convert the NAD 83 (our official national horizontal geodetic datum) ellipsoid heights from GNSS surveys into NAVD 88 (our official national vertical datum) orthometric heights.

Geoid Height

The separation distance between the reference ellipsoid (GRS 80) and the hybrid geoid model surface (e.g., Geoid 09). The combination of the NAD 83 ellipsoid height from GNSS observations and this value enables a NAVD 88 orthometric height to be produced. The geoid height is positive away from the earth center and negative towards it (it is below the ellipsoid across the CONUS). The RT user should have this model loaded into the data collector to be used whether a localization is performed or not.

Geometric Dilution of Precision (GDOP)

See Dilution of Precision. An indicator of the geometrical strength of a GPS constellation used for a position/time solution (horizontal, vertical & time).

Global Navigation Satellite System (GNSS)

This is an umbrella term used to describe the generic satellite-based navigation/positioning system(s). It was coined by international agencies such as the International Civil Aviation Organization (ICAO) to refer to both GPS and GLONASS, as well as any augmentations to these systems, and to any future civilian developed satellite system. For example, the Europeans refer to GNSS-1 as being the combination of GPS and GLONASS, but GNSS-2 is the blueprint for an entirely new system. Future constellations may include China's Compass/Beidou, Europe's Galileo, Japan's QZSS, etc.

Global'naya Navigatsionnaya Sputnikovaya Sistema / Global Orbiting Navigation Satellite System (GLONASS)

This is the Russian Federation counterpart to GPS. It is designed to consist of a constellation of 24 satellites (though the number is presently less due to difficulties in funding for the system) transmitting on a variety of frequencies in the ranges from 1597-1617 MHz and 1240-1260 MHz (each satellite transmits on different L₁ and L₂ frequencies). GLONASS provides worldwide coverage, however its accuracy performance is optimized for northern latitudes, where it is better than GPS's SPS. GLONASS positions are referred to a different datum than GPS, i.e. PZ90 rather than WGS84. Most firmware/software converts from the PZ90 datum to WGS 84 for processing.

Global Positioning System (GPS)

A system for providing precise location which is based on data transmitted from a constellation of 30+ satellites. It comprises three segments: (a) the Control Segment, (b) the Space Segment, and (c) the User Segment. The GPS constellation is a realization of the WGS 84 datum and is maintained by the Department of Defense. Users access the satellite specific codes and the L-band carrier signals to obtain positions using multilateration or for navigation.

GPS Surveying

Conventional static GPS surveying has the following characteristics:

- The GNSS receivers are all stationary.
- GNSS data are collected in the receivers over an observation session, typically ranging in length from 20 minutes to several hours.
- The results are obtained after post processing.
- The positioning is obtained from relative positioning.
- A variety of processing and error mitigation algorithms can be employed, including frequency combinations.
- Mostly associated with the traditional surveying and mapping functions.
- This method gives the highest accuracy and most reliability for GNSS positioning.

Single base RT GPS surveying has the following characteristics:

- One receiver is stationary for an entire campaign. One or more receivers are “rovers” that briefly visit points to be recovered or located.
- GPS data are computed in the rover and displayed in the data collector in a few seconds or minutes.
- The point of interest is obtained from relative positioning from the stationary receiver.
- initialization is done “on the fly”.
- Accuracy/precision is at the centimeter or two level which is sufficient for most surveying and engineering applications.

Additionally, GPS can be used for kinematic applications (navigation).

GPS Time (GPST)

GPST is a form of Atomic Time, as is, for example, Coordinated Universal Time (UTC). GPST is "steered" over the long run to keep within one microsecond of UTC. The major difference is that while "leap seconds" are inserted into the UTC time scale every 18 months or so to keep UTC approximately synchronized with the earth's rotational period (with respect to the sun), GPST has no leap seconds. At the integer second level, GPST matched UTC in 1980, but because of the leap seconds inserted since then, GPST is now ahead of UTC by 14 seconds (plus a fraction of a microsecond that varies from day to day). The relationship between GPST and UTC is transmitted within the Navigation Message.

Grid

A map coordinate system that projects the surface of the earth onto a flat surface such as the State Plane (SPC) or the Universal Transverse Mercator (UTM) coordinate systems. Mapping grids have rectilinear zones for position measurements and are based on strict Cartesian coordinates. Map grid coordinates are always distorted with respect to their geodetic counterparts (latitude and longitude), and map grids are typically designed to minimize certain types of distortion. For example, for equal area projections the area in the mapping plane is the same as the corresponding area on the reference ellipsoid. For conformal projections, angles are preserved such that lines intersecting on the ellipsoid intersect at the same angle in the mapping plane, which tends to maintain shapes. Both State Plane and UTM are conformal, and no projection can be both conformal and equal area.

Ground plane

A large flat metal surface, or electrically charged field, surrounding a GPS antenna used to shield the phase center from reflected signals.

- H -

Height (Ellipsoid)

Height above or below a mathematically defined ellipsoid (e.g., GRS 80 or WGS 84) that approximates the surface of the Earth at the geoid. The height coordinate determined from GNSS observations is related to the surface of the WGS 84 reference ellipsoid. The WGS 84 ellipsoid height is natively displayed in RT GNSS positioning in a transformation from the original computed ECEF X,Y,Z coordinates to latitude, longitude and *ellipsoid height*. However, data collection firmware can transform this into an orthometric height by use of a geoid model or by localization to several known vertical bench marks.

Height (Orthometric)

The Orthometric Height is the height of a point – usually on the earth's surface, measured as a distance along the curved local plumb line and normal to gravity from the reference surface to that station. The official US vertical datum is NAVD 88. Heights above or below that datum can be obtained through GNSS methods by using the current hybrid geoid model and the NAD 83 ellipsoid heights.

$$H = C / \bar{g} = \text{True Orthometric Height.}$$

\bar{g} is the average gravity along the plumb line which is impossible to know. Therefore, we use Helmert orthometric heights which approximate the average gravity by using surface gravity (g) and assuming a constant value for crustal density, and ignoring topographic relief. C is the geopotential number which is a non-geometric value in units of specific energy (e.g., m^2/s^2) of the difference in gravitational acceleration or potential between two equipotential surfaces reckoned as positive up (i.e., C increases as the geopotential decreases).

$$H = C / (g + 0.0424 H_0) = \text{Helmert Orthometric Height}$$

Hertz

A unit used to measure a wave's frequency, one cycle per second. The three GPS frequencies are 1575.42 MHz, 1227.60 MHz and 1176.45 MHz (future). GLONASS uses unique frequencies in the L band for each satellite.

- I -

I/O

Abbreviation for Input/Output.

Ionosphere, Ionospheric Delay

The Ionosphere is that band of atmosphere extending from about 50 to 1000 km above the earth in which the sun's radiation frees electrons from the gas molecules (typically oxygen and nitrogen) present creating ions. The free electrons affect the speed and direction of the GNSS signals. The Ionospheric group delay

is frequency-dependent (“dispersive”) and inversely proportional to the frequency. Therefore, the higher the frequency, the less is the ionospheric effect. A linear combination of the two GPS frequencies can substantially eliminate first order iono delay errors. The magnitude of the Ionospheric Delay is a function of the latitude of the receiver, the season, the time of day, and the level of solar activity. RT positioning assumes identical ionospheric conditions for base and rover and thus the error terms are neglected. The residual errors are baseline distance correlated, typically combined with the tropospheric error residuals and orbital errors, into a 1-PPM error factor.

Ionosphere-Free Combination

A linear combination of the GPS L_1 and L_2 carrier phase measurements which provides an estimate of the carrier phase observation on one frequency with the effects of the ionosphere removed. It provides a different ambiguity value (non-integer) than a simple measurement on that frequency. However, there still remain unmodeled ionospheric errors of between 1 – 3 cm due to conditions such as the bending of the signal.

The ionosphere-free L_1 carrier phase combination (in units of L_1 wavelengths) is:

$$f(L_1)_{ion-free} = a1.f(L_1) + a2.f(L_2)$$

with $a1 = f1^2 / (f1^2 - f2^2)$ and $a2 = -f1 \cdot f2 / (f1^2 - f2^2)$, $f1$ and $f2$ are the frequencies of the L_1 and L_2 carrier waves respectively. (A similar expression can be developed for the ionosphere-free L_2 carrier phase.) The ionosphere-free pseudo-range combination (in metric units) is:

$P_{ion-free} = b1.P(L_1) + b2.P(L_2)$ Iono-Free Carrier Phase Observation with

$$b1 = f1^2 / (f1^2 - f2^2) \text{ and } b2 = -f2^2 / (f1^2 - f2^2) .$$

International Global Navigation Satellite System Service (IGS)

An initiative of the International Association of Geodesy, as well as several other scientific organizations, which was established as a service at the beginning of 1994. The IGS is comprised of many component civilian agencies working cooperatively to operate a permanent global GNSS tracking network, to analyze the recorded data and to disseminate the results to users via the Internet. The range of "products" of the IGS include precise post-mission GPS satellite ephemerides, tracking station coordinates, earth orientation parameters, satellite clock corrections, tropospheric and ionospheric models. Although these were originally intended for the geodetic community as an aid to carrying out precise surveys for monitoring crustal motion, the range of users has since expanded dramatically, and the utility of the IGS

is such that it is vital to the definition and maintenance of the International Terrestrial Reference System (and its various "frame realizations" (ITRF96,ITRF2000, ITRF2005 etc.).

International Terrestrial Reference System (ITRS)

The most precise, geocentric, globally-defined coordinate system or datum of the earth. It is a more accurate than the WGS84 Datum. The various "frames" (such as ITRF2000, etc.) are realizations of the ITRS for a particular epoch in time, consisting of a set of 3-D coordinates and **velocities** for hundreds of geodetic stations around the world (all coordinates of fixed stations on the earth change with time due to plate tectonics). Although some of the stations are Satellite Laser Ranging (SLR) stations, or Very Long Baseline Interferometry (VLBI) stations, the vast majority are GNSS tracking stations of the IGS network. The ITRS is managed by the International Earth Rotation and Reference System Service (IERS) – a scientific organization with a Central Bureau in Frankfurt, Germany.

- J -

- K -

Kalman Filter

An iterative mathematical procedure for estimating dynamically changing positions, such as the position and/or velocity of a rover, from observations. The a priori dynamic condition is usually input to the filter (e.g., walking, car, plane, etc.) to help the program develop appropriate weighting and to remove outliers from its solution sets.

Kinematic Positioning

The user's GPS antenna is moving. In GPS, this term is typically used with precise carrier phase positioning, and the term “differential or dynamic positioning” is used with pseudorange positioning. Applications of Kinematic RT positioning include topography across open terrain, road profiling and shoreline locations. It can produce a line or a series of points by setting the observation parameters to automatically log locations at user selected distance and/or time intervals.

- L -

L₁ Frequency

The 1575.42MHz GPS carrier frequency which contains the C/A-Code, the encrypted P-Code (or Y-Code) and the Navigation Message. Commercial GPS navigation receivers can track only the L₁ carrier to make pseudo-range (and sometime carrier phase and Doppler frequency) measurements, while the P code can only be accessed for military applications.

L₂ Frequency

The 1227.60MHz GPS carrier frequency which contains only the encrypted P-Code (or Y-Code) and the Navigation Message. Military Y-Code capable receivers can, in addition to making L₁ measurements, make pseudo-range measurements on the L₂ carrier. The combination of the two measurements (on L₁ and L₂) permits the Ionospheric Delay to be corrected for, since the ionosphere affects the different frequencies inversely to the square of their frequency. Dual-frequency GPS receivers intended for surveying applications can make L₂ measurements using proprietary signal processing techniques. Such measurements are essential if the Ionospheric Delay on carrier phase is to be corrected (especially on baselines of length greater than about 20-30km) and/or where fast Ambiguity Resolution is needed. Other combinations include wide lane (L₁ - L₂) and narrow lane (L₁ + L₂).

L-Band

The group of radio frequencies extending from 390MHz to 1550MHz. The GPS carrier frequencies L₁ and L₂ are in the L-Band.

Latency

The age or time lapse in corrections used in RT GPS. The longer the time lapse between the corrections, the less accurate they become at the rover.

- M -

Multipath

Interference caused by reflected GPS signals arriving at the receiver, typically as a result of nearby structures or other reflective surfaces. The reflected signal is delayed causing an apparent longer distance to the satellite. May be mitigated to some extent through appropriate antenna design, antenna placement and special filtering algorithms within GPS receivers in static observations, but not for the brief time on point for RT positioning. Usually the noise effect on RT positioning is a few centimeters unless it causes an incorrect ambiguity resolution, which might result in decimeters of error.

- N -

NAD 83

The North American Datum of 1983. The official national horizontal datum for the United States as stated in the Federal Register / Vol. 60, No. 157, Docket No. 950728196--5196-011. NAD 83 is a three dimensional datum with the coordinates of points usually expressed in latitude, longitude and ellipsoid height. The current realization, NAD 83(CORS 96), is defined in terms of a 14 parameter Helmert transformation from the International Terrestrial Reference Frame of 1996. The NAD 83 origin located near the center of mass of the earth is biased relative to that of the ITRF by about 2.24 meters.

Narrow Lane Observable

The GPS observable obtained by summing the carrier-phase observations of a single epoch measured in cycles, on the L_1 and L_2 frequencies. That is $L_1 + L_2$. The effective wavelength of the narrow-lane observable is 10.7 centimeters. The narrow-lane observable can help resolve carrier-phase ambiguities.

Navigation Message

Contains the satellite's broadcast ephemeris, satellite clock bias correction parameters, constellation almanac information and satellite health. A 1500 bit message modulated on the L_1 and L_2 GPS signal broadcast approximately every 12.5 minutes.

NAVD 88

The North American Vertical Datum of 1988.

NAVSTAR

The GPS satellite system of the DoD. NAVSTAR is an acronym for “NAVigation Satellite Timing and Ranging”.

NMEA

National Marine Electronics Association, a U.S. standards body that defines message structure, content and protocols to allow electronic equipment installed within ships and boats to communicate with each other. GPS receivers can be configured to output various types of messages in the "NMEA format". The NMEA GSV message type should contain signal to noise ratio information and the GGA message contains the raw position..

Noise

An interfering signal that tends to mask the desired signal at the receiver output and which can be caused by space and atmospheric phenomena, can be human made, or can be caused by receiver circuitry. Also called White Noise.

- O -

OEM

Original Equipment Manufacturer. Typically GPS receiver "boardsets", “chip sets” or "engines" that a product developer can embed within some application or hardware package.

On-The-Fly (OTF)

This is a form of Ambiguity Resolution (AR) which does not require that the rover receiver remain stationary for any length of time. Hence this AR technique is suitable for initializing RTK Positioning. For many applications this introduces considerable flexibility. If a loss of lock occurs, the rover can reinitialize wherever it is located without revisiting a known point.

Oscillator

A device that generates a signal of a given frequency within the receiver.

Outage

Defined as a loss of availability of positional display data and computation, due to either there not being enough satellites visible to calculate a position (at least 5 are needed), or the value of the PDOP indicator is greater than some user specified value which prevents locations from being taken.

- P -

P-Code

The Precise or Protected code. A pseudorandom string of bits that is used by GPS receivers to determine the range to the transmitting GPS satellite on the GPS L_1 and L_2 carrier at a chip rate of 10.23MHz (approximately 10 times the resolution of the C/A code), which repeats about every 267 days. Each one-week segment of this code is unique to a GPS satellite and is reset each week. Under the policy of the DoD, the P-code is replaced by an encrypted Y-code when Anti-Spoofing is active. Y-code is intended to be available only to authorized (primarily military) users.

Phase Center

The apparent center of signal reception at an antenna. The electrical phase center of an antenna is not constant but is dependent upon the observation angle and azimuth to the satellite. The L_1 and L_2 phase centers are at different locations.

Position

The 3-D coordinates of a point, usually given in the form of latitude, longitude, and ellipsoidal height, though it may be provided in the 3-D Cartesian form (ECEF X,Y,Z), or any other transformed map or geodetic reference system. An estimate of error is often associated with a position.

Position Dilution of Precision (PDOP)

See Dilution of Precision. Measure of the geometrical strength of the GPS satellite configuration for 3-D positioning.

Post-Processed GNSS

In post-processed GNSS the base and user (or roving or mobile) receivers have no data communication link between them. Instead, each receiver records the satellite observations that will allow the processing of double-differenced observables (in the case of carrier phase-based positioning) at a later time. Data processing software is used to combine and process the data collected from these receivers.

Precise Positioning Service (PPS)

The most accurate absolute positioning possible with GPS navigation receivers, based on the dual-frequency encrypted P-Code. Available to the military users of GPS. Typical accuracy is of the order of 30 cm.

Precision

The degree of **repeatability** that measurements of the same quantity display, and is therefore a means of describing the quality of the data with respect to random errors. Precision is traditionally measured using the standard deviation and therefore is shown in the **RMS** error on the data collector screen. It can be thought of as the spread of the positional error.

Pseudo-Random Noise (PRN) Number

A number assigned by the GPS system designers to a given set of binary signals with random noise-like properties. It is generated by mathematical algorithm or "code", consisting of a repeated pattern of 1's and 0's. The C/A-Code and the P-Code are examples of PRN codes. Each GPS satellite transmits a unique

C/A-Code and P-Code sequence (on the same L_1 and L_2 frequencies), and hence a satellite may be identified according to its "PRN number", e.g. PRN2 or PRN14 are particular GPS satellites.

Pseudo-Range

A distance measurement based on the alignment of a satellite's time tagged transmitted code (may be the C/A-Code or the encrypted P-Code) and the local receiver's generated reference code (for that PRN satellite number), that has not been corrected for clock bias. Hence a pseudo-range measurement is a distance measurement biased by a time error. The C/A-Code pseudo-range measurements may have a spread of meters. The pseudorange is obtained by multiplying the apparent difference in time by "c" (the speed of light).

- R -

Range

The distance between two points, such as between a satellite and a GNSS receiver. Can be called Topocentric or Geometric range.

Real-Time Kinematic (RTK or RT)

The relative positioning procedure whereby carrier phase observables and corrections for each L_1 and L_2 signal to each common satellite are transmitted in RT from a reference or base station to the user's rover receiver. The rover receiver processes the data in RT. Centimeter level accuracy is achieved without any post processing.

Reference Station

A ground station at a known location used to derive differential corrections. The reference station receiver tracks all satellites in view, corrects pseudorange errors, and then transmits the corrections with the carrier phase observables to the rover. Since all positions calculated are from vectors relative to the reference station, an autonomous position can be used in the field. When the true position is entered into the project, either in the field or office, all rover positions are updated to be relative to that position. Also called a base station.

Relative Positioning

The determination of relative positions between two or more receivers which are simultaneously tracking the same GNSS signals. One receiver is generally referred to as the reference or base station, whose coordinates are usually known in the project datum. The second receiver (rover) moves to various points to be recovered or located. Its coordinates are determined relative to the base station. In carrier phase-based positioning this results from the determination of the delta X,Y,Z coordinates applied as a baseline vector, which is added to the base station's coordinates to generate the rover's coordinates.

Relative Precision

Precision is defined as a measure of the spread of a set of numbers around a number determined by the set (e.g. the **mean**). This is typically shown in a normal distribution as the standard deviation (σ) with respect to the mean. This is reflected in the data collector screen as the **RMS**. Relative precision shows the range of the components (X, Y, Z or N, E, up) between one station and other.

Root Mean Square (RMS)

Mathematically, it is the square root of the average of the sum of the squared residuals from the computed value. The RMS error typically approximates the 68 percent confidence level in individual spatial components (north, east or up). Double the value to get the approximate 95 percent confidence level for a component of the RT position. It is not related to satellite geometry, but rather is a geometry-free position solution spread of results.

Rover

Any mobile GPS receiver collecting data during a field session. The receiver's position is computed in the rover receiver relative to a stationary GNSS receiver at a base station.

Radio Technical Commission for Maritime Services (RTCM)

RTCM Special Committee 104 develops standard message types for use in differential GNSS positioning. The message content has been defined and hence when the RTCM-104 standard (version 3.1 is the latest)

is implemented within a user receiver, it is able to decode and apply the differential corrections to its raw data in order to generate an error corrected coordinate.

- S -

Satellite Constellation

The orbiting satellites and their broadcast signals. The GNSS refers to the entire array of available satellites. GPS, GLONASS, Galileo and Compass are some individual constellations that can be used for positioning, navigation and timing – either collectively as they become available or individually.

Selective Availability (S/A)

Intentional degradation of the autonomous position capability of the GPS for civilian use by the U.S. military. This is accomplished by artificially "dithering" the clock error in the satellites and truncating the satellite ephemeris. S/A was activated on 25 March 1990, and was "turned down" on the 1st of May 2000 (midnight Washington D.C. time).

Signal to Noise Ratio (SNR, S/N, C/N₀)

The ratio of incoming signal strength to the amount of interfering noise as measured in decibels on a logarithmic scale. Measurements have good reliability if the SNR is 30 or greater.

Single Difference

A GPS observable formed by arithmetically differencing carrier phases that are simultaneously measured by a pair of receivers tracking the same satellite, or by a single receiver tracking a pair of satellites. The between-receiver's single difference procedure removes all satellite clock and hardware errors or conversely, the between-satellite's single difference procedure removes the receiver's clock and hardware errors. (see Appendix B)

Spatial Decorrelation

The increase in positional errors due to the increase in distance between the user and the reference station. When calculating differential corrections, the greater the distance between the two, the greater the error residual in the corrections. Errors that are thus correlated are commonly expressed in parts per million (PPM). These are primarily dispersive (frequency dependent) as in the ionospheric advance and refractive delay, and non-dispersive (geometrical) as in the tropospheric delay and refraction and in the orbital errors.

Standard Positioning Service (SPS)

The civilian absolute positioning accuracy obtained by using the pseudo-range data obtained with the aid of a standard single or dual frequency C/A-Code GPS receiver. Autonomous positioning currently yields around 10 m accuracy with SA turned down.

- T -

TDOP

Time Dilution of Precision. See DOP

Triple-Difference

A linear combination of double-difference carrier phase observables by which the cycle ambiguity parameters can be eliminated and which is less affected by unrepaired cycle slips than double-differences. A triple-differenced observable is created by differencing two consecutive double-differences (the same pair of receivers and the same pair of satellites, but separated in time). A useful observable for obtaining approximate baseline solutions or for detecting cycle slips in the double-differenced observables.

Troposphere, Tropospheric Delay

The Troposphere is the neutral atmosphere from the earth's surface to around 50 km altitude. The Tropospheric Delay on GPS signals is of the non-dispersive variety because it is not frequency-dependent and hence impacts on both the L_1 and L_2 signals by the same amount (unlike that within the Ionosphere). The wet and dry components of the Troposphere cause the signal refraction and delay, with the wet component be responsible for approximately 10 percent of the total delay, but being hard to model correctly. The dry or hydrostatic component is more easily modeled. Various Tropospheric models (Saastamoinen, Modified Hopfield, etc.) have been developed to estimate the delay as a function of the satellite elevation angle, receiver height, and "weather" components such as temperature, pressure and humidity. Zenith total delay (ZTD) is between 2 and 3 meters, but increases as the satellite is closer to the horizon to a factor of 5. RT processing essentially ignores differences in tropospheric conditions between the rover and base and therefore residual errors increase with baseline length. RT should not be performed with adverse or differing tropospheric conditions – such as when a weather front is passing through the project.

Time-To-First-Fix (TTFF)

The actual time required by a GPS receiver to achieve a position solution. The time will vary with site conditions, receiver type and whether the rover has carried any satellites from a previous loss of lock.

- U -

Ultra High Frequency (UHF)

Radio frequencies in the band from 300 MHz to 3,000 MHz

User Equivalent Range Error (UERE)

Any error contributing to the error budget of autonomous GPS receiver positioning, expressed as an equivalent error in the range between a user's antenna and a satellite. UERE errors originate from different sources and thus are independent of each other. The total UERE is the square root of the sum of the squares of the individual errors. A prediction of maximum anticipated total UERE (minus ionospheric error) is provided in each satellite's navigation message as the user range accuracy (URA).

Sources of User Equivalent Range Errors (UERE)

Source	Effect
Ionospheric effects	± 5 meter
Ephemeris errors	± 2.5 meter
Satellite clock errors	± 2 meter
Multipath distortion	± 1 meter
Tropospheric effects	± 0.5 meter
Numerical errors	± 1 meter

UTC (Coordinated Universal Time)

This is the atomic time standard basis of our everyday time keeping. This time scale is kept by time laboratories around the world, including the U.S. Naval Observatory, and is determined using highly precise atomic clocks. *Universal Time* (UT), on the other hand, (usually denoted as *UT1*) is a measure of the rotation angle of the Earth as observed astronomically. UTC is not permitted to differ from UT1 by more than 0.9 second. When it appears that the difference between the two kinds of time may approach this limit, a one-second change called a "leap second" is introduced into UTC. This occurs on average about once every year to a year and a half. This is not because the earth is slowing in rotation, but rather because the rate of time keeping is different between the two and the rotation rate fluctuates. UTC is readily obtained from the GPS satellites.

- V -

Variance

The square of the standard deviation

Very High Frequency (VHF)

Radio frequencies in the band from 30 MHz to 300 MHz.

Wide-Lane Observable

The GPS observable obtained by differencing the carrier-phase observations of a single epoch measured, in cycles, on the L_1 and L_2 frequencies. That is, $L_1 - L_2$. The effective wavelength is 86.2 centimeters. It can be useful in resolving carrier-phase ambiguities.

World Geodetic System 1984 (WGS84)

A global geodetic datum defined and maintained by the DoD. As the control segment coordinates and the broadcast ephemerides are expressed in this datum, the autonomous GNSS positioning results are said to be in the WGS84 datum. WGS 84 positions differs from NAD 83 between 1 and 2 meters .

Augmentation of the constellations will enable users to see this difference with uncorrected handheld units in the near future. The WGS84, PZ 90.02 and ITRS are compatible at the few centimeters level. However, the ITRS is a more precise realization of an ECEF terrestrial reference system as shown in the iterations of the ITRF.

References

- 1) Ahn, Yong Won (M.Sc. thesis), (2005), Analysis of NGS CORS Network for GPS RTK Performance Using External NOAA Tropospheric Corrections Integrated with a Multiple Reference Station Approach, UCGE Report 20211.
- 2) Beutler, G., Bauersima, I., Gurtner, W., Rothacher, M., Schildknecht, T. & Geiger, A., (1989). Atmospheric refraction and other important biases in GPS carrier phase observations. In monograph 12, Atmospheric Effects on Geodetic Space Measurements, F.K.Brunner (ed.), School of Geomatic Engineering (formerly Surveying), The University of New South Wales, 15-44.
- 3) Caltrans/Division of Right of Way and Land Surveys, Surveys Manual, (2006).webpage http://www.dot.ca.gov/hq/row/landsurveys/SurveysManual/Manual_TOC.html
- 4) Caroline Erickson (M.Sc. thesis),(1992), Investigations of C/A Code and Carrier Measurements and Techniques for Rapid Static GPS Surveys, UCGE Report No. 20044.
<http://www.geomatics.ucalgary.ca/Papers/Thesis/GL/92.20044>
- 5) Dennis, Michael L., (2008), “Ground Truth- Design and Documentation of Low Distortion Projections for Surveying and GIS”, Arizona Professional Land Surveyors 2008 workshop paper.
- 6) Dao, Thi Hong Diep, (2005). Performance Evaluation of Multiple Reference Station GPS RTK for a Medium Scale Network. UCGE Report 20214.
<http://www.geomatics.ucalgary.ca/links/GradTheses.html>
- 7) Eckl, M.C., Snay, R.A., Soler, T., Cline, M.W., & Mader, G.L.,(2002), Accuracy of GPS Derived Relative Positions As a Function of Interstation Distance and Observing Station Duration. Journal of Geodesy, 75 (12):pp 633-640.
- 8) Gutman, S., T. Fuller-Rowell and D. Robinson, (2003). Using NOAA Atmospheric Models to Improve Ionospheric and Tropospheric Corrections, U.S. Coast Guard Differential GPS Symposium, June 2003, Portsmouth, USA
http://www.gpsmet.noaa.gov/jsp/downloads/NOAA_Atmospheric_Corrections.ppt.
- 9) International Organization for Standardization (ISO) TC 172/SC 6, (2008).Optics And Optical Instruments- Field Procedures For Testing Geodetic And Surveying Instruments - Part 8: GNSS Field Measurement Systems In Real-Time Kinematic (RTK),
http://www.iso.org/iso/iso_catalogue/catalogue_tc/catalogue_detail.htm?csnumber=42213
- 10) Landau, H. and Euler, H. J., (1992), On-The-Fly Ambiguity Resolution for Precise Differential Positioning, ION GPS-92 Proceedings, Albuquerque, New Mexico, pp. 607-613.

- 11) Langley, R.B., (1997), GPS Receiver System Noise, GPS World, Vol. 8, No. 6, pp.40-45
- 12) Leick, A., (2004), Wiley, GPS Satellite Surveying, 3rd Edition
- 13) Mader, G. (1990): Ambiguity Function Techniques for GPS Phase Initialization and Kinematic Solutions. Proceedings of the Second International Symposium on Precise Positioning with the Global Positioning System, Ottawa, Canada, Sept. 1990.
- 14) Meyer, T.H., Bean, J.E., Ferguson, C.R. & Naismith, J.M., (2002), The Effect of Broadleaf Canopies on Survey-Grade Horizontal GPS/GLONASS Measurements, Surveying and Land Information Science 62(4), 215–224.
- 15) Meyer, T. H., Hiscox, A.,(2005), Position Errors Caused By GPS Height of Instrument Blunders, webpage http://digitalcommons.uconn.edu/thmeyer_articles/4/
- 16) New York State Department of Transportation/Land Surveying section, (2005), Land Surveying Standards and Procedures Manual. webpage <https://www.nysdot.gov/portal/page/portal/divisions/engineering/design/design-services/land-survey/standards-procedures>
- 17) NOAA (2005) Space Weather Prediction Center. webpage. <http://www.sec.noaa.gov>
- 15) Remondi, B. W., (1984), Using the Global Positioning System (GPS) phase observable for relative geodesy: modeling, processing, and results, PhD Thesis, University of Texas at Austin.
- 16) Remondi, B. W., Performing Centimeter-Level Surveys in Seconds with GPS Carrier Phase: Initial Results, Journal of The Institute of Navigation, Vol. 32, No. 4, Winter 1985-6
- 17) Rizos, C., (1999), Principles and Practice of GPS Surveying, accessed via the web, July 2008: http://www.gmat.unsw.edu.au/snap/gps/gps_survey/principles_gps.htm
- 18) Yang X., Brock R., RDOP Surface for GPS Relative Positioning, United States Patent 6057800, issued May 2, 2000, web page <http://www.patentstorm.us/patents/6057800-fulltext.html>
- 19) Zilkoski, D.; D'onofrio, J.; Frakes, S. (1997). NOAA Technical Memorandum NOS-NGS-58 Guidelines for Establishing GPS-Derived Ellipsoid Heights (Standards: 2 cm and 5cm) Version 4.3, November 1997, webpage: http://www.ngs.noaa.gov/PUBS_LIB/NGS-58.html
- 20) Zilkoski, D.; Carlson, E.; Smith, C., (2005). Draft Guidelines for Establishing GPS-Derived Orthometric Heights (Standards: 2 cm and 5 cm) Version 1.4. webpage: http://www.ngs.noaa.gov/PUBS_LIB/pub_index.html

APPENDIX A

Abstract

Real Time Kinematic (RTK) surveying has been in use now for over a decade. However, there is minimal documentation available relative to suggested field procedures designed to produce positions of specific accuracies. Additionally, the methods for transmitting and receiving RTK corrections have expanded to include the use of cellular modems, thus overcoming the distance dependency of traditional UHF radio broadcasts and most manufactures support the collection and processing of Global Navigation Satellite Systems (GNSS) such as GLONASS. The below describes a case study into the use of single base RTK GNSS corrections being generated by the VT CORS Network and accessed with a cellular modem. The Vermont CORS Network is briefly described. Occupation time, baseline length, and field procedures are discussed and compared. The results of this case study indicate that the guidelines listed for RT1, RT2, RT3, and RT4 will in fact produce the stated accuracies.

Introduction

In the fall of 2006, the Vermont Agency of Transportation began an ambitious effort to establish a state-wide network of Continuously Operating GNSS Reference Stations (CORS). This CORS infrastructure would be designed to provide both archived data for post-processing as well as real-time corrections (single baseline) to support Real Time Kinematic (RTK) surveys. By the spring of 2007 the first eleven stations were in place and available for real-time applications. The Vermont CORS network is being designed to have a station spacing of approximately 40km to 50km. (See figure 1)

The GNSS antenna's for the CORS were positioned relative to NAD83 CORS96(Epoch 2002) by submitting numerous 12-hour datasets to the NGS' Online User Positioning Service (OPUS). The OPUS solutions for each station were combined and then averaged to establish the position of the GNSS Antenna Reference Point (ARP).

Field Testing Procedure

Stations to be occupied

RTK observations were taken on existing control stations that are part of the National Spatial Reference System

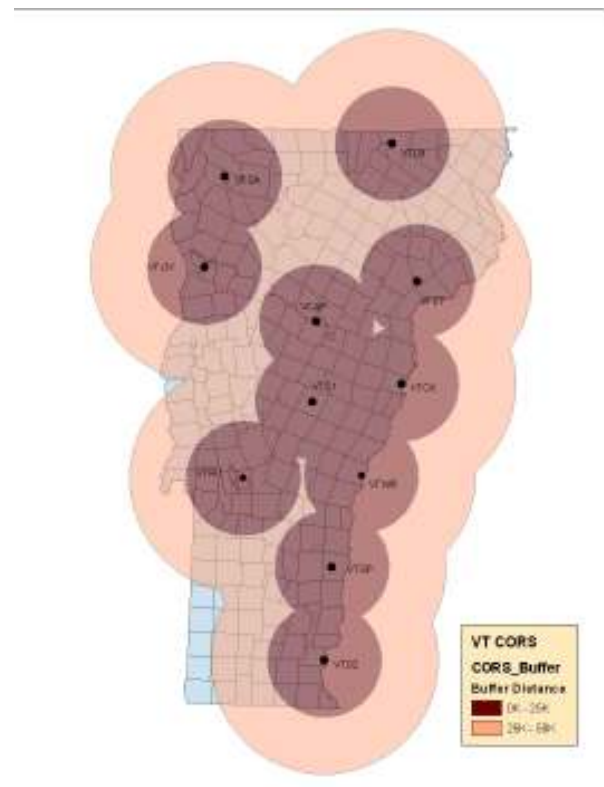

Figure 1 - Current configuration of VT CORS Network

(NSRS). The published coordinates from the new national readjustment (NAD83 NSRS2007) would be used as truth. Whenever possible, stations that also had a

APPENDIX A

published NAVD88 orthometric height would be used.

Baseline Lengths

Multiple baseline lengths would be tested to include the maximum expected distance from the nearest CORS once the network is complete. Proposed network design indicates this may be as much as 30km. For the purpose of this study, baseline lengths of more than double the expected network spacing were also tested.

In order to test at various baseline lengths, three test stations were selected in the central Vermont area. Observations were taken relative to three or more CORS at each station in order to gain samples at various distances. Table 1 shows the base/field station combinations used.

CORS	Field Station	Distance (m)
VCAP	SKYL	7888
VCAP	SOBA	11263
VTC1	LLCZ	17140
VCAP	LLCZ	19400
VTC1	SOBA	27097
VTC1	SKYL	30536
VTWR	LLCZ	52358
VTWR	SOBA	60397
VTUV	SOBA	63773
VTWR	SKYL	64112

Table 1 - Station Combinations for VT Procedure

Observation Scheme

When the draft guidelines became available for review, it was decided to implement these procedures in the field and collect data sets for analysis. Since it is Vermont's intent to base all of their RTK observations on their CORS stations, no "classical" RTK observations were taken. That is to say that since the Vermont CORS provided the

control, and the VT CORS stations are spaced at 40km – 50km the ability to conduct observations from two bases at each station within specified distances was not possible for the RT1 and RT2 classifications. Regardless of the distance constraints, data was collected at each station using the observation time for all accuracy classes. Additionally, the draft guidelines call for maximum Positional Dilution of Precision (PDOP) and Route Mean Square (RMS) criteria for positions collected under each accuracy class. It was decided that data would be collected regardless of the conditions at the time of observation and that the observation statistics would be extracted from the data after the fact for analysis.

On Site Collection Procedure

1. Setup bipod/antenna and start survey
2. Initialize to nearest CORS
3. Collect observation using the criteria for RT1, RT2, RT3 and RT4 in rapid succession (regardless of actual field conditions)
4. End survey
5. Start new survey
6. Initialize to a different CORS
7. Repeat steps 3-6 using a number of CORS stations
8. End Survey
9. Move to different test locations and repeat steps 1-8
10. Repeat procedure steps 1-9 four or more hours later

Alternative On Site Collection Procedure (Unique Initializations):

1. Setup bipod/antenna and start survey
2. Initialize to nearest CORS
3. Collect one observation at 30 epochs
4. End survey/shut off receiver
5. Restart receiver and start survey
6. Repeat steps 2-5 a number of times

APPENDIX A

Accuracy and Precision Analysis

The precision analysis will make a comparison of repeat observations relative to their difference from the mean. Accuracy analysis will be conducted by showing the difference in field derived values as compared to truth (published NSRS stations).

For this study, three separate individual field observers were used. Each observer worked independently in the field. All data was grouped by individual observer, and then later merged by accuracy class. Since a large amount of data was collected for this study, the analysis was first done based on the individual observer's data.

Data by Observer

Data was collected by Observers 1 and 2 2008 on Julian days 030 and 032 and on Julian days 025 and 026 by Observer 3. The data for each observer was organized by accuracy class and coordinate differences for each day were computed from the published station coordinates of each station he occupied. The average of the two observations was also computed. Figure 2 shows the comparison of the Day1 and Day2 and average observations differenced from the published values for the Northing, Easting and Ellipsoid height components respectively. The error bars on each data point show the RT1 precision constraint of +/- 1.5 cm horizontal and +/- 2.5 cm vertical. These graphs give both an indication of the accuracy of the observations as well as the precision. The reader will certainly observe that one of the data points contains a significant error both in accuracy and precision. On inspection of the data, it was determined that this is a classic example of a bad initialization. Although it does not happen often, it does

happen. It was determined that the Day2 observation contained the bad initialization as this error carried through to all observations taken under this initialization. This was further verified in that other observations taken at this particular station from the same base provided acceptable results. The observations associated with the bad initialization were rejected from the test data and will not be shown in any further graphs in order to better depict the accuracy/precision of the remaining data sets.

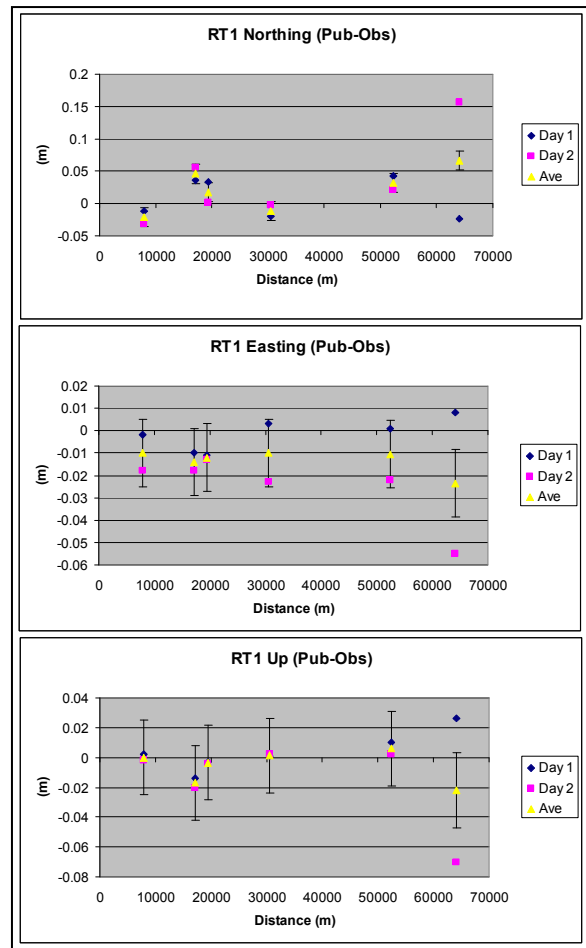

Figure 2 – Comparison of Day1, Day2 and Average N, E, and U (published-observed) vs. baseline length using RT1 field procedures. Y-error bar scale is 1.5cm horizontal and 2.5cm vertical.

APPENDIX A

As can be seen from each dataset's deviation from the mean, the Day1 and Day2 observations agree well within the specified RT1 precision tolerances even at distances of over 50km. The accuracy of the observations relative to the published values generally tends to agree within +/- 2cm with the exception of the northing average at 17km and 52km. Both of these distances represent observations taken at LLCZ and could therefore represent an error in the published value of LLCZ. Further discussion on accuracy will follow later.

Figures 3, 4, and 5 show the comparison of the Day1 and Day2 and average observations for the RT2, RT3, and RT4 observations taken by observer 1 differenced from the published values for the Northing, Easting and Ellipsoid height components respectively. The error bars on each data point show the RT1 precision constraint of +/- 1.5 cm horizontal and +/- 2.5 cm vertical. It is important to remember that these observations were not necessarily collected at the lower limit of the all allowable constraints of the error classes. For instance, the minimum number of satellites observed for an RT4 observation is five, however the observations taken may have included as many as 13 satellites; in other words, the only observation criterion used in the field was duration of the observation.

When reviewing the plots for Observer 1, it can be inferred that there does not appear to be any degradation of precision or accuracy relative to the duration of observation. There does however appear to a linear trend relative to the average accuracy of the ellipsoid height vs. baseline distance. This was an interesting feature and somewhat expected as it is commonly accepted that GNSS RTK errors are correlated to distance.

Evidence of this is seen in manufacturer specifications, i.e., RMS errors of 1cm+1ppm horizontal and 2cm+1ppm vertical. However, after looking at similar plots for Observer 2 and Observer 3 (Figures 4 and 5) it is clear that this feature is non-existent in these observations. Additionally, there does not appear to be any notable difference in the magnitude of the vertical errors relative to the horizontal errors. This is further illustrated later when data from all observations are combined.

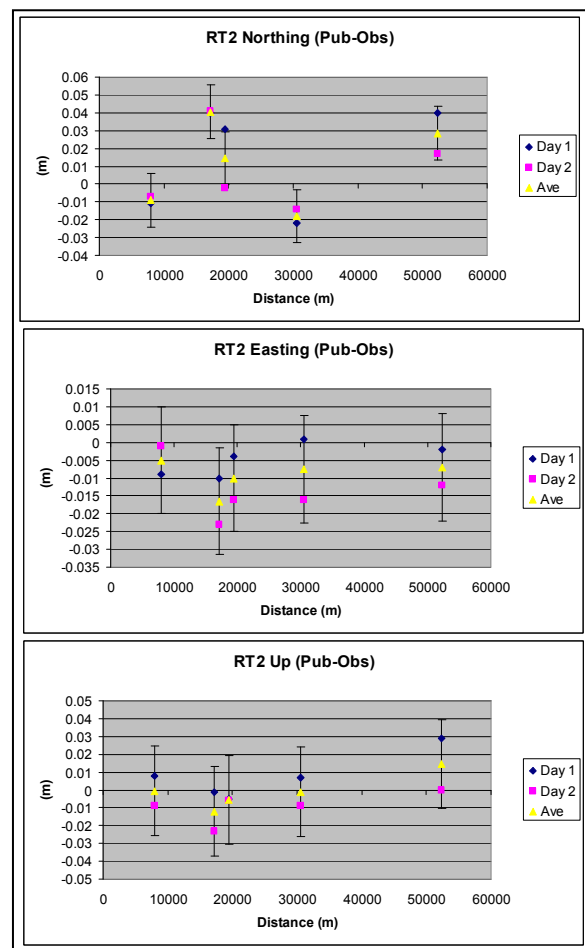

Figure 3 – Comparison of Day1, Day2 and Average N, E, and U (published-observed) vs. baseline length using RT2 field procedures. Y-error bar scale is 1.5cm horizontal and 2.5cm vertical.

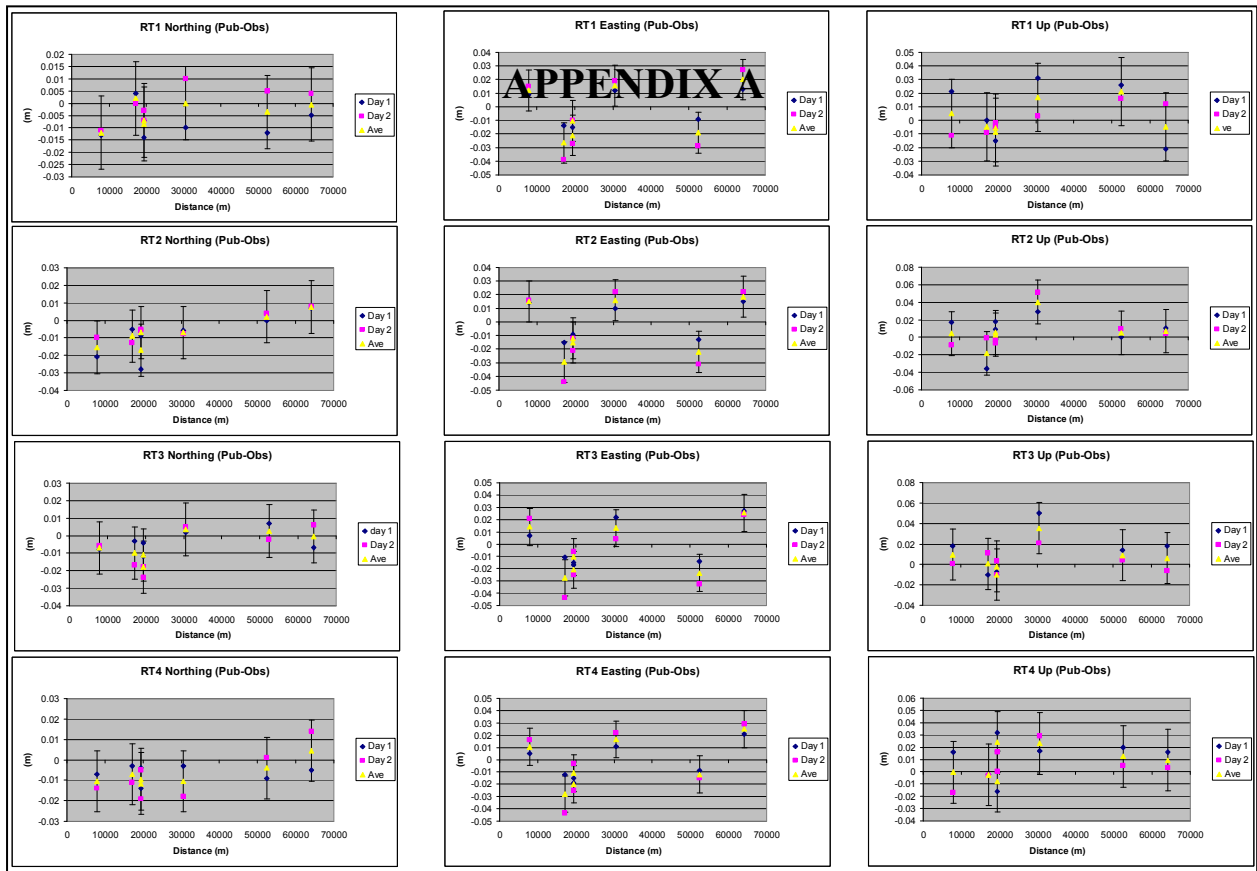

Figure 4 – Observer 2 Day1, Day2 and Average N, E, and U (published-observed) vs. baseline length using RT1 – RT4 field procedures. Y-error bar scale is 1.5cm horizontal and 2.5cm vertical.

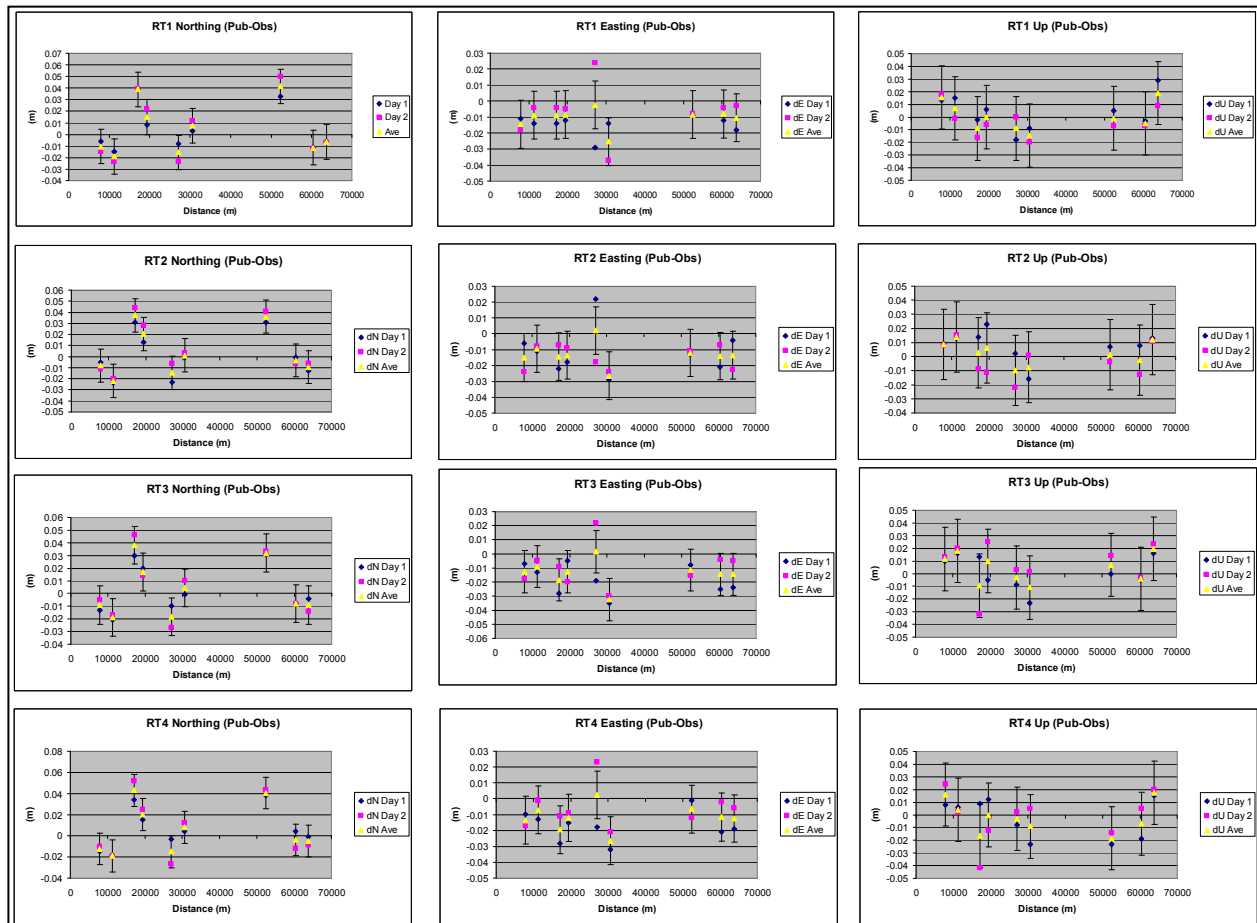

Figure 5 – Observer 3 Day1, Day2 and Average N, E, and U (published-observed) vs. baseline length using RT1 – RT4 field procedures. Y-error bar scale is 1.5cm horizontal and 2.5cm vertical.

APPENDIX A

Also of notable interest is the fact that all observations meet the RT1 precision horizontal cutoff of 1.5cm and 2.5cm horizontal and vertical based on the individual component differences. This is not a true indicator as the guidelines are based on a horizontal (resultant) and vertical repeatability at 95%. However it allows us to view individual component differences looking for trends or biases.

It was noted before that the northing difference (published-observed) at LLCZ might indicate an error in the published value for this station. Comparing the average northing differences for this station from each observer shows that both Observer 1 and Observer 3 show a difference from the published northing of LLCZ of about +4cm while Observer 2 shows a difference of approximately -1cm. This would generally indicate that there could in fact be an issue with the published northing for LLCZ. As a check, two hours of static data was collected at LLCZ and submitted both to the NGS Online Positioning User Service (OPUS) and OPUS Rapid Static (OPUS-RS). The OPUS and OPUS-RS derived coordinates verified that northing of LLCZ appeared to be about 2cm out. The OPUS-derived position for LLCZ was input as the published value and the data replotted. Figures 6 and 7 show the RT1 northing plots for Observer 2 and Observer 3 using the OPUS-derived coordinate.

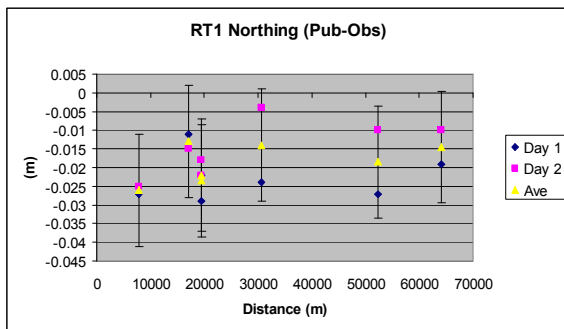

Figure 6 – Observer 2 (OPUS as published)

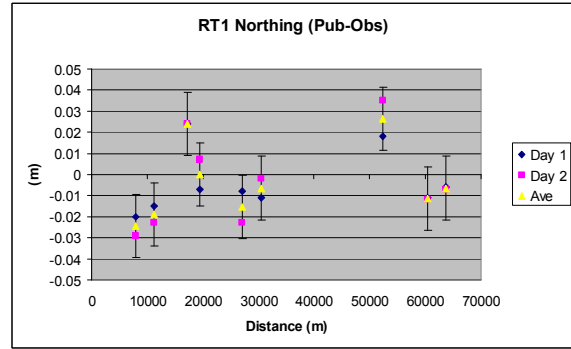

Figure 7 – Observer 3 (OPUS as published)

LLCZ can be seen at the two data points at 17km and 52km. The observations between Observers 2 and 3 are now within a couple of cm of truth however there is still a significant disagreement between the two. The site at which LLCZ is set would tend to dictate that observers orient their bipods approximately the same way each time it was observed. There is a dirt road to the north of the station and thick grasses to the west, south, and east. It was confirmed that each observer did indeed set their bipods with the bubbles to the north when observations were taken. Since observer one and three used the same equipment, this might indicate that the bubble on one of the two bipods was out of adjustment and that an equipment bias was introduced.

Data by Accuracy Class

Further analysis was conducted by combining all observers' data by Accuracy Class in order to better determine if differences in perceived accuracy were evident. See Figure 8.

Examination of Figure 8 would again seem to indicate that there was a loss of accuracy based on duration of observation. With the exception of the northing component at 17km and 52km (LLCZ) the component residuals generally fall within +/- 2cm of the published values. It is also noted that there appear to be clusters of points representing

APPENDIX A

different accuracy classes. On further examination of the data, it can be seen that these clusters represent data points collected under the same initialization. The field collection procedure dictated that the observers initialize to a CORS and collect RT1-RT4 observations under the same initialization. This would indicate that the observation time is generally independent of the accuracy and that the determining factor is the initialization itself.

deviation of the component differences for each accuracy class.

	σN (m)	σE (m)	σh (m)
RT1	0.021	0.012	0.011
RT2	0.020	0.013	0.012
RT3	0.020	0.014	0.014
RT4	0.021	0.013	0.014

Table 2 – Standard Deviation of the average of Day1-Day2 observations

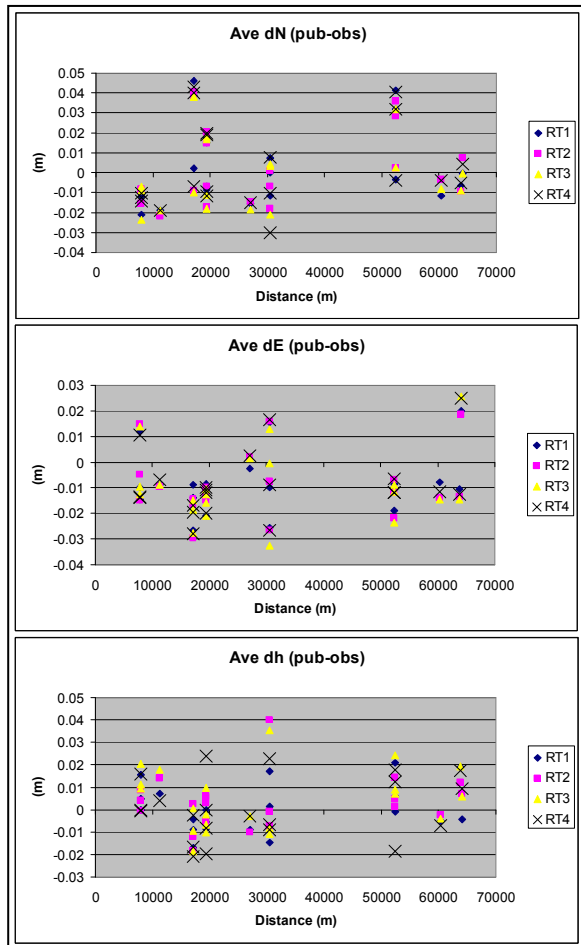

Figure 8 – Combined data (average day1-day2) from all observers separated into accuracy classes.

A visual inspection of Figure 8 does infer however that there appears to be more random scatter in vertical plot, especially in the RT4 observations. To quantify the differences, Table 2 shows the standard

Table 2 illustrates that there is no significant difference in the precision of the horizontal components relative to duration of observation. There is however a minor improvement with observation time in the vertical component. It should be noted that the standard deviation of the northing component includes the suspect observations at LLCZ. If those observations are removed, the standard deviation into the 1cm to 1.5cm range and is very comparable to standard deviation shown for the easting component. Table 2 also shows that the vertical precision is equally as good as the horizontal precision.

Field Requirements (Quality Indicators)

There are a number of quality indicators available to the observer in the field. Though not a guarantee that the field measurements are precise, or will yield an accurate position, these indicators are used to help insure quality data. Information that is readily available to the observer in the field consists of the number of the satellites being observed, the geometry of those satellites (Dilution of Precision), and the field derived precision of the measurement being taken (RMS). This section will look at these indicators and determine their affect

APPENDIX A

on precision and accuracy of the field derived positions.

Number of Satellites

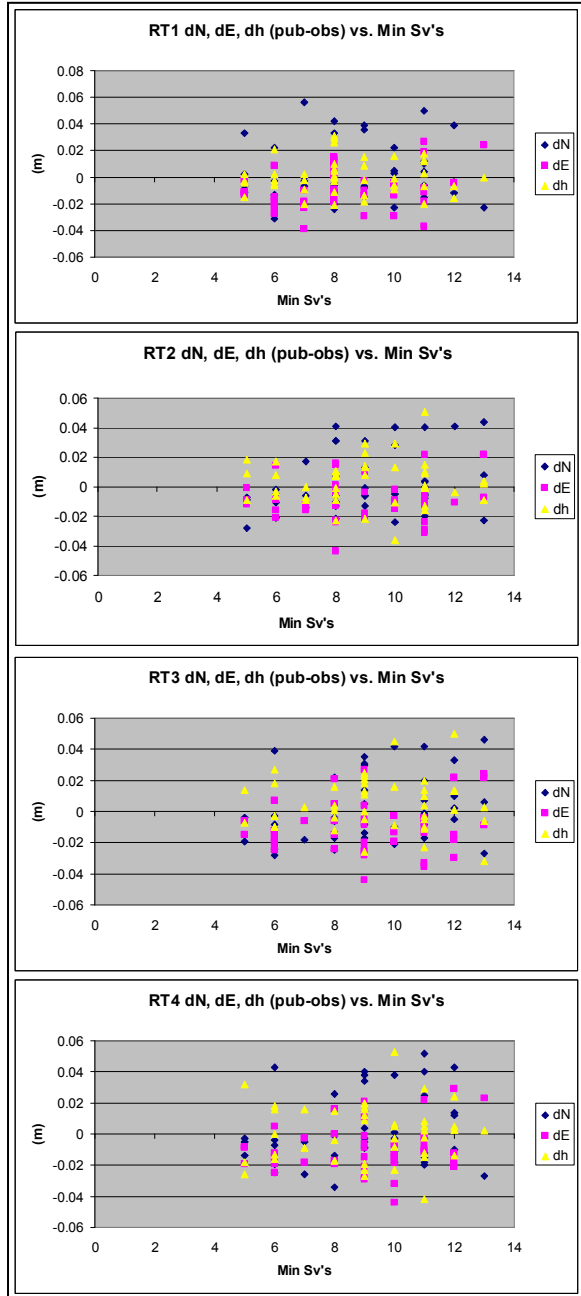

Figure 9 – Plots showing RT1-RT4 observations plotted vs. minimum number of satellites during occupation.

Component residuals from each of the RT classes (published-observed) were plotted relative to the number of satellites used in

each solution. Figure 9 illustrates this comparison. Based on visual inspection of the plots, there appears to be little correlation if any.

Field Derived RMS

The RMS observed in the field is a direct measurement of the precision of the derived position. That is to say that it is a measure of the scatter of all epochs that went into the final derivation of the position or vector. It should be noted also that measure is usually in the form of a two dimensional horizontal RMS and a one dimensional vertical RMS as opposed to showing each component individually. The horizontal RMS is used as an indicator in the NGS guidelines.

In order make a direct comparison, it was necessary to compute a horizontal resultant of the northing and easting residuals (published-observed). This was simply done by using the equation:

$$\sqrt{(N_{pub} - N_{obs})^2 + (E_{pub} - E_{obs})^2}$$

This calculation was performed for each data point so that a two dimensional horizontal displacement could be determined. These numbers, being component resultants will have a positive sign and will indicate only the distance on the ground from the published value. A direction could be computed but for this exercise it is not relevant. Figure 10 show the component resultants plotted relative to field RMS. As with most of these plots, the magnitude of the data points are of little concern as it is the precision or repeatability that is of importance. Specifically, in Figure 10 we are looking for any correlation between the component resultants and the field RMS. As with the plot relative to minimum number of satellites, there does not appear to be any correlation.

APPENDIX A

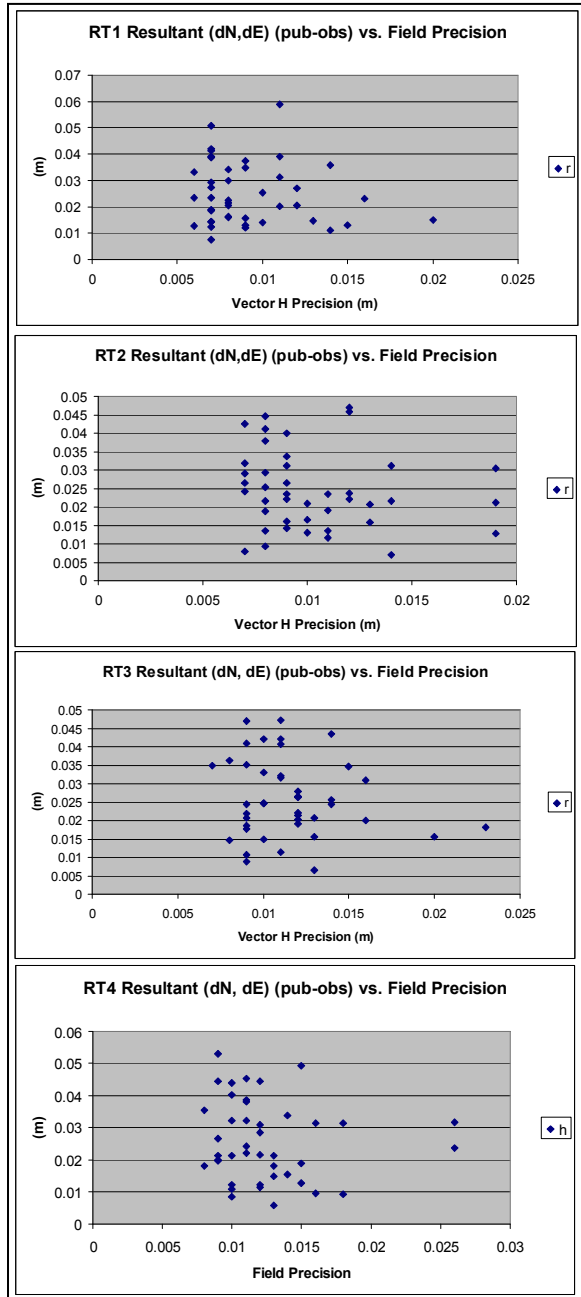

Figure 10 – Plots showing RT1-RT4 observations plotted vs. field precision (RMS) during occupation.

It can be seen though that the field RMS improves with time on station. That is to say that the longer one observes, the lower the RMS. This is evident when looking at the upper and lower limits and distribution of the RMS in the RT1 and RT4 plots. The question is whether this field RMS actually translates to accuracy. For instance, the one

bad initialization that was shown earlier had a field RMS of less than 1cm.

PDOP (Position Dilution Of Precision)

At the beginning of this study, it was thought that the PDOP could be recovered from the field data after the fact. This was not the case. Though the PDOP was available to the observer in the field, it was not available for reporting once the data was downloaded. The indicator that was available was RDOP, or Relative Dilution Of Precision.

Unlike PDOP, which is a measure of satellite geometry at a single epoch relative to a single point being positioned, RDOP considers the changing satellite geometry over the length of an observation session at both stations that define a baseline. An investigation published by Yang and Brock (2000) indicate that “In contrast to the commonly used values of PDOP which indicate the effect of the instantaneous satellite geometry at a single epoch on point positioning, the values of RDOP give information about the effect of the continuously changing satellite geometry over a certain observation period on relative positioning. Similar to PDOP, the lower the value of RDOP the better the solution of a GPS baseline.”

The RDOP quality indicator does not appear to be widely supported by most GNSS manufacturers but since it is the only DOP that we had available it was used for this study.

According to Yang and Brock (2000) and Trimble (1991), RDOP values of less than three tend to indicate that the duration of the observation session was long enough to allow for sufficient change in satellite geometry to produce accurate baselines.

APPENDIX A

Trimble (1991) goes on to say that a baseline with a low RDOP that has poor ratio might indicate that other factors such as ionosphere could be causing problems. Figure 11 shows the coordinate residuals (published-observed) relative to session RDOP.

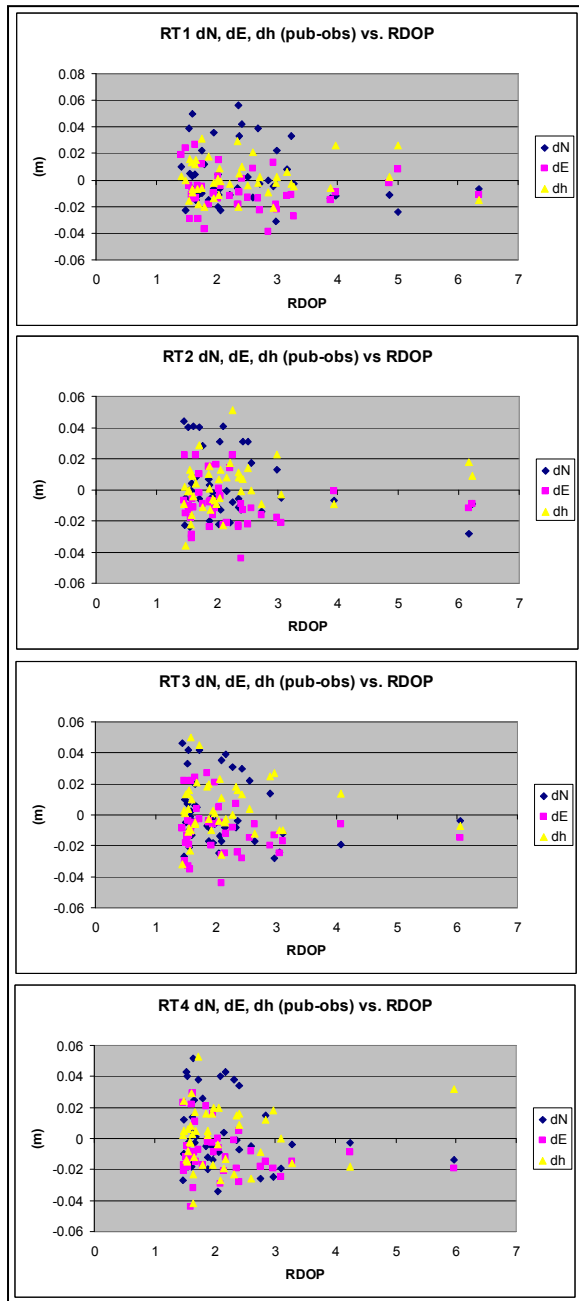

Figure 11 – Plots showing RT1-RT4 observations plotted vs. RDOP.

It should be pointed out that the suspect data for LLCZ is still included. This is easily seen when looking at the northing residuals. The northing residuals that plot at around 4 cm or higher can be attributed to this suspect data. The inclusion of these points tends to give the appearance of a negative correlation of precision to RDOP, however if the suspect residuals are visually ignored the distribution of the data points appear to be much more random and suggest no correlation.

Final Tests relative to Accuracy Class

Finally we will look at all data specific to their accuracy class and test them against precision cutoffs listed in the guidelines. We will also look at a measure of accuracy to determine if the same results are repeatable through independent observations conducted by other parties.

Precision Measures

The real time accuracy classes are defined by an observer's ability to take two measurements at a location under different conditions and obtain agreement of each of the observations within a certain separation from their mean. That is to say that in order to meet the requirement for the RT1 accuracy class, the two observations must agree horizontally with their mean to within 1.5 cm and vertically with their mean to within 2.5 cm. In order to test the horizontal precision the following equation was derived:

$$H \text{ Resultant} = \sqrt{\left(\frac{dN_{d1} - dN_{d2}}{2}\right)^2 + \left(\frac{dE_{d1} - dE_{d2}}{2}\right)^2}$$

Where $H \text{ Resultant}$ = the spatial difference from the mean of each set of redundant

APPENDIX A

observations, dN and dE are the delta northing and easting (published-observed) and subscripts $d1$ and $d2$ denote day1 and day2 observations. The vertical precision was simply computed by the equation:

$$V = \frac{dh_{d1} - dh_{d2}}{2}$$

Where V is the vertical height difference (ellipsoidal) from the mean of each set of redundant observations, dh is the delta ellipsoid height (published-observed) and subscripts $d1$ and $d2$ denote day1 and day2 observations.

Figure 12 shows the results of this analysis and is a direct measure of precision relative to an observer's ability to repeat a measurement within a certain tolerance. The lines on the graph labeled as "H Env" and "V Env" are respectively the Horizontal and Vertical RT Class tolerance envelope. The RT4 tolerance envelope was not plotted as all data points are well within that tolerance and plotting the RT4 envelope would only serve to make the graph less readable.

The results in Figure 12 show that all individual precisions are within the specified tolerances. Also shown on each plot are the combined horizontal and vertical precisions at 95%. As has already been seen, there is no significant difference in the horizontal precision between the different accuracy classes but there is a definite noticeable improvement in the vertical relative to the length of observation based on the 95% precisions.

The 95% horizontal and vertical precisions were computed using the draft National Standard for Spatial Data Accuracy (FGDC 1997) where the 95% accuracy level for circular error is defined as $1\sigma * 2.4477$. The final FGDC standard was published in 1998

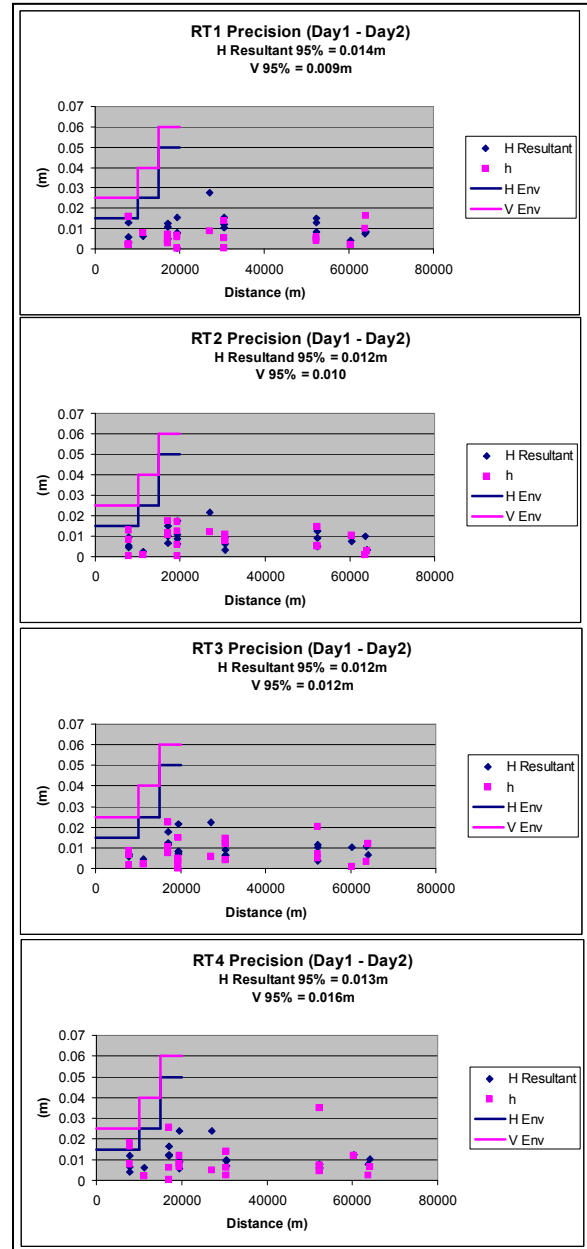

Figure 12 – Plots showing RT1-RT4 average horizontal and vertical observation differences from day1 and day2. “H env” and “V env” are respectively the horizontal and vertical RT1-RT3 class tolerance envelopes.

and is based on Route Mean Square Error (RMSE) as opposed to standard deviation. The use of the draft standard was an oversight by the author; however the difference in computational statistics is insignificant at this stage as we are primarily concerned with precisions not accuracies.

APPENDIX A

Transitioning Precision Measures to Accuracy Measures

The accuracy of a measurement is defined by how closely the measurement compares to truth. In this case study, measurements were taken at points with known coordinates so accuracy can be tested by comparing our measurements to these known values. More importantly, we can measure the scatter of the data for each accuracy class collected by different observers. By doing this, we can determine any observer's ability to be within some statistical horizontal radius and vertical separation from each other. In lieu of a known value, the average of all observers' measurements would best represent truth. Figure 13 shows the average radial error for each observation set (Day1, Day2). Figure 14 shows the corresponding average vertical error for each observation set.

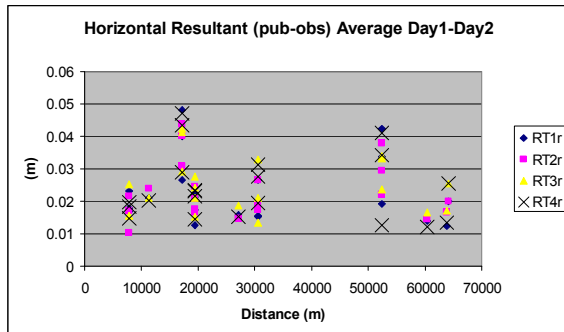

Figure 13 – Plot showing RT1-RT4 average radial error (Published – Average Day1, Day2).

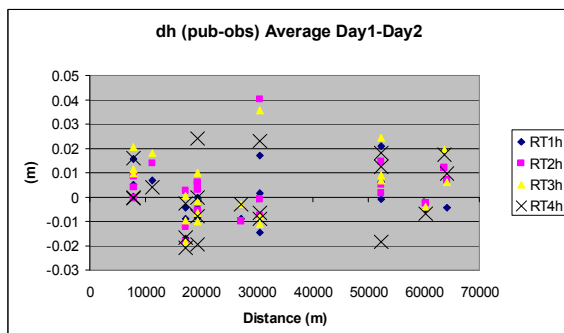

Figure 14 – Plot showing RT1-RT4 average vertical error (published – Average Day1, Day2).

As before, the larger residuals at LLCZ have been left in the analysis but as previously indicated, these observations may contain an equipment bias. Table 3 shows the horizontal and vertical 2σ error estimates from the data contained in figures 13 and 14.

	2σ Horizontal (m)	2σ Vertical (m)
RT1	0.024663	0.020933
RT2	0.021754	0.023475
RT3	0.020684	0.027002
RT4	0.025223	0.027488

Table 3 – Horizontal and Vertical 2σ Error Estimates (Average of Day1-Day2 observations)

Table 4 shows the horizontal 2σ error estimates if the large residuals at LLCZ are removed from the analysis.

	2σ Horizontal (m)
RT1	0.010786
RT2	0.011772
RT3	0.013639
RT4	0.014448

Table 4 – Horizontal 2σ Error Estimates (Average of Day1-Day2 observations) with Large LLCZ Residuals Removed

Tables 3 and 4 are showing the observers' ability to produce the same radial error. For instance, table 4 indicates that observations taken under RT1 criterion will produce a radial error that is within 0.011 meters of similar observations 95% of the time. These numbers directly correspond to the expected accuracy of one observer's coordinate determination relative to another observer's coordinate determination.

As was seen previously, the precision of the vertical component decreases slightly as observations are shortened. Also, now that the suspect data at LLCZ has been removed (Table 4), a slight decrease in horizontal

APPENDIX A

precision is also evident as observation times were shortened. Figure 15 shows the relationship of horizontal and vertical 2σ precisions relative to the length of observation.

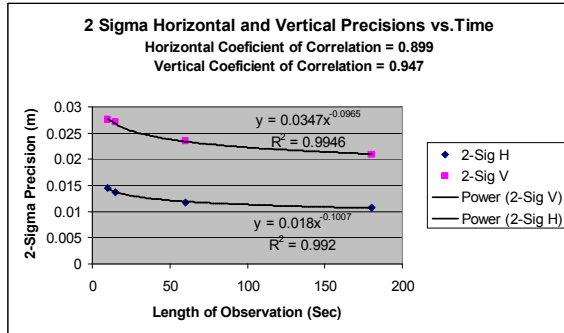

Figure 15 – Plot 2σ Horizontal and Vertical Precisions relative to Length of Observation.

Though the overall differences between the 10 second (RT4) and 180 second (RT1) observations are in the range of millimeters, it is clear that a correlation exists, as is further illustrated by the horizontal and vertical correlation coefficients at the top of the plot.

Computing Horizontal and Vertical Accuracies

According to the Federal Geographic Data Committee (1998), horizontal error at point i is defined as:

$$\sqrt{(x_{data,i} - x_{check,i})^2 + (y_{data,i} - y_{check,i})^2}$$

where $x_{data,i}$ and $y_{data,i}$ are the x and y values from the field data and $x_{check,i}$ and $y_{check,i}$ are the published x and y values.

Horizontal accuracy is defined in terms of radial Route Mean Square Error ($RMSE_r$) and is determined with the equation:

$$\sqrt{\frac{\sum((x_{data,i} - x_{check,i})^2 + (y_{data,i} - y_{check,i})^2)}{n}}$$

where n is the number of check points tested. Horizontal accuracy at 95% is computed by the formula:

If the x and y errors are assumed to be equal then $Accuracy_r = 1.7308 * RMSE_r$

Vertical Accuracy at 95% = $Accuracy_z = 1.96 * RMSE_z$

$$RMSE_z = \sqrt{\frac{\sum(z_{data,i} - z_{check,i})^2}{n}}$$

Table 5 lists the 95% horizontal and vertical accuracies as defined by the FGDC National Standard for Spatial Data Accuracy (NSSDA).

	95%($RMSE_r$) (m)	95%($RMSE_z$) (m)
RT1	0.032967	0.018825
RT2	0.033251	0.0237233
RT3	0.036622	0.027924
RT4	0.036143	0.026851

Table 5 – NSSDA Horizontal and Vertical Accuracy (Average of Day1-Day2 observations) for RT1-RT4 observations with Large LLCZ Residuals Removed

Technically speaking, the accuracy test that was just performed is designed for spatial data not survey data. The proper way to determine accuracies for survey data is through a properly weighted least squares adjustment. As this data has not been run through an adjustment, the only way to determine accuracies is through an analysis similar to the one performed here.

As was seen in the precision analysis (table 4), the accuracy analysis indicates a correlation between accuracy and observation time. This is most noticeable in the horizontal accuracy results.

APPENDIX A

Another interesting feature that exists in Table 5 is that the apparent vertical accuracy is better than the horizontal accuracy. Since the horizontal precisions in Table 4 were very good, and the accuracy test contains all errors including those associated with the check coordinates, this would indicate the presence of a bias in either the published horizontal coordinates or the field derived horizontal coordinates. A horizontal bias could also exist between the published coordinates for the CORS stations and those of the check stations. Without a high-order resurvey of the three check stations relative to CORS, there is no way to determine the exact cause of the larger horizontal accuracies.

Discussion

A number of the results shown in this study appear to be contrary to commonly accepted beliefs relative to GNSS Surveys. However, it must also be pointed out that this study is very limited in its scope as it was conducted using only one type of equipment; in one part of the country which tends to have a dryer troposphere than other parts of the country, say Florida or Southern Louisiana. This study was also conducted at a time when the ionosphere is quite. In fact, we are currently at the lowest point on the curve of the 11-year solar cycle.

In this study:

- More satellites observed did not result in better precisions. However it should be noted that field observations designed to test the worst case scenario of each accuracy class
- Observations with lower DOP values were not determined to be better than those with higher DOP values. But as with criterion for minimum number of satellites, the observations

were not designed to test the worst case.

- The length of observed baseline had little to no affect on the relative precision of the baselines.
- Lower field RMS did not yield better horizontal or vertical precisions in the office.

Some common beliefs were also reinforced:

- The precision of each of the horizontal components appeared to be about equal the precision of the vertical component. However once the data was cleansed of some high residual outliers, it was seen that in fact the horizontal precisions were better than the vertical. Based on this study, the horizontal 2-dimensional position is better than the vertical 1-dimensional position by a factor of 1.9.
- The horizontal and vertical precision first appeared to be independent of length of occupation. However once the data was cleansed of some high residual outliers, both the horizontal and vertical precisions showed a strong correlation to length of occupation.

Based on this discussion, it is clear that more research is needed. Future research should:

- Include many different models of GNSS equipment to include those that are both GLONASS and non-GLONASS capable.
- Be conducted in other parts of the county to include areas with a wetter troposphere.
- Continue to be conducted or re-conducted periodically as we climb up the curve toward solar-max to measure the effect of active ionosphere.

APPENDIX A

Conclusions

As the use of RTK positioning continues to increase, so does the need for development of standards, specifications, and guidelines designed to meet specific levels of precision and accuracy. The results shown in this case study are very encouraging relative to the ability to produce observations of high precision with “Single Base RTK”. In fact the results far exceeded the author’s expectations relative to the NGS Accuracy Classes. Further research may show that some of the observation criterion listed such as minimum number of satellites, PDOP, and RMS may be relaxed or may be shown to have little to no effect on one’s ability to produce precise RTK measurements.

The case study reported here shows that Single Base RTK observations can be taken over significantly long distances up to (60 km) and still produce results that meet or approach the precision levels of much shorter observations. It is also shown that the duration or length of observation is a definite factor in the precision of RTK measurements. Finally, it can be concluded that if:

- Observations are designed with proper redundancy to remove systematic errors (tropo, iono) and detect bad initializations;
- The data is analyzed to detect and remove statistical outliers;

Single Base RTK observations that meet or exceed the precision criterion of the NGS Single Base Guidelines for RT1, RT2, RT3, and RT4 accuracy classes is achievable carried out under normal field conditions similar to those experienced during this case study.

References

- FGCD. 1997. *Draft Geospatial Positioning Accuracy Standards Part 3: National Standard for Spatial Data Accuracy*. May 1997. Federal Geographic Data Committee, 590 National Center, Reston, VA, 20192
- Federal Geographic Data Committee. 1998. *Geospatial Positioning Accuracy Standards Part 3: National Standard for Spatial Data Accuracy*. 1998. Federal Geographic Data Committee, 590 National Center, Reston, VA, 20192
- Trimble 1991. *Trimvec-Plus GPS Survey Software, User’s Manual and Technical Reference Guide*. September, 1991, P 3-12.
- Yang, X., and R. Brock. 2000. *RDOP Surface for GPS Relative Positioning*. United States Patent Claim 6057800, [<http://www.patentstory.us/patents/6057800-fulltext.html>]

Appendix B

Differencing and Ambiguity Resolution

This section graphically depicts the differencing sequence as it progresses through single and double differencing. Triple differencing is used to check for cycle slips and top narrow the search radius for ambiguity resolution.

First given is the undifferenced observable equation in cycles delineating the error sources and unknowns. Note that after differencing and ambiguity resolution, the multipath error is still unmodeled and remains in the positional error. The observable equations are solved for both L₁ and L₂ frequencies to each acquired satellite.

See Leick, (2004)

Undifferenced Carrier Phase Observable $\varphi_k^p(t)$

$$\varphi_k^p(t) = \frac{f}{c} \rho_k^p(t) - f dt_k(t) + f dt^p(t) + N_k^p - I_{k,\varphi}^p(t) + \frac{f}{c} T_k^p(t) + d_{k,\varphi}(t) + d_{k,\varphi}^p(t) + d_\varphi^p(t) + \varepsilon_\varphi$$

Superscripts refer to the satellite, subscripts refer to ground station

φ : Carrier phase observable in cycles φ_k^p refers to the carrier phase observable from SV p to Station k.

f : Carrier frequency

L1= 5.255 CYCLES PER METER)

c : Speed of light

$\rho(t)$: The topocentric range ρ_k^p is the range from SV p to Station k.

$d_k(t)$: Receiver clock bias as a function of time

$dt^p(t)$: SV clock error as a function of time

N_k^p : The integer ambiguity from SV p to Station k

$I_k^p(t)$: Ionospheric advance $I_{k,\varphi}^p$ is the Ionospheric advance from SV p to Station k in cycles

$T(t)$: Tropospheric delay T_k^p is the tropospheric delay from SV p to Station k

$d_{k,p}^r(t)$: Receiver hardware delays in cycles as a function of time

$d_{k,p}^m(t)$: Multipath in cycles as a function of time

$d_p^s(t)$: Satellite hardware delays in cycles as a function of time

σ_p : Measurement noise in cycles

φ_k^p is the actual phase observable recorded in the receiver.

The terms to the right of the equal sign model various components that make up the observable.

N_k^p is the initial integer count of the number of cycles from SV p to Station k. This is also referred to as the integer ambiguity. Unlike the other modeled terms to the right of the equal sign, it is not a function of time, as long as the receiver maintains lock on the SV signal this number will not change.

When a receiver locks onto a signal from the GPS satellite, it continuously monitors the satellite transmission. At predetermined epochs, the receiver records the data at that epoch. The frequency with which the receiver records data is the data sampling rate. The data sampling rate is frequently incorrectly described as "epochs". For example, it is often, "Data was collected at 30 second epochs." The correct terminology is, "Data was collected with a data sampling rate of 30 seconds." An *epoch* is a particular instant in time. The time between epochs is an *interval*.

Single-Difference

A **single difference** is the difference between two **undifferenced** observables for the same satellite at the same epoch.

$\varphi_k^p(t) = \varphi_k^p(t) - \varphi_m^p(t)$ is the single difference between SV p and Stations k and m at epoch t.

$$\begin{aligned} \varphi_{km}^p(t) &= \varphi_k^p(t) - \varphi_m^p(t) \\ &= \frac{f}{c} \rho_k^p(t) - f dt_k(t) + f dt^p(t) + N_k^p - I_{k,\varphi}^p(t) + \frac{f}{c} T_k^p(t) + d_{k,\varphi}(t) + d_{k,\varphi}^p(t) + d_\varphi^p(t) + s_{k,\varphi}^p \\ &\quad - \left(\frac{f}{c} \rho_m^p(t) - f dt_m(t) + f dt^p(t) + N_m^p - I_{m,\varphi}^p(t) + \frac{f}{c} T_m^p(t) + d_{m,\varphi}(t) + d_{m,\varphi}^p(t) + d_\varphi^p(t) + s_{m,\varphi}^p \right) \\ &= \frac{f}{c} (\rho_k^p(t) - \rho_m^p(t)) - f (dt_k(t) - dt_m(t)) + f (\cancel{dt^p(t)} - \cancel{dt^p(t)}) + (N_k^p - N_m^p) - (I_{k,\varphi}^p(t) - I_{m,\varphi}^p(t)) \\ &\quad + \frac{f}{c} (T_k^p(t) - T_m^p(t)) + (d_{k,\varphi}(t) - d_{m,\varphi}(t)) + (d_{k,\varphi}^p(t) - d_{m,\varphi}^p(t)) + (\cancel{d_\varphi^p(t)} - \cancel{d_\varphi^p(t)}) + (s_{k,\varphi}^p - s_{m,\varphi}^p) \\ &= \frac{f}{c} (\rho_k^p(t) - \rho_m^p(t)) - f (dt_k(t) - dt_m(t)) + N_{km}^p - I_{km,\varphi}^p + \frac{f}{c} T_{km}^p(t) + d_{km,\varphi}(t) + d_{km,\varphi}^p(t) + s_{km,\varphi}^p \end{aligned}$$

The satellite clock errors and satellite hardware delays cancel.

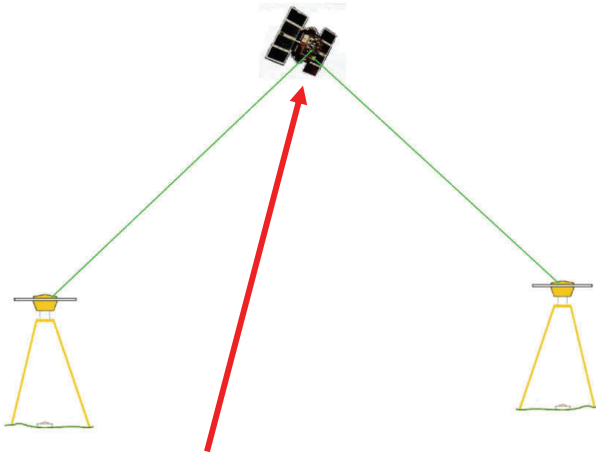

Two receivers, one satellite, same epoch.

Eliminates satellite clock error,
satellite hardware error

OR

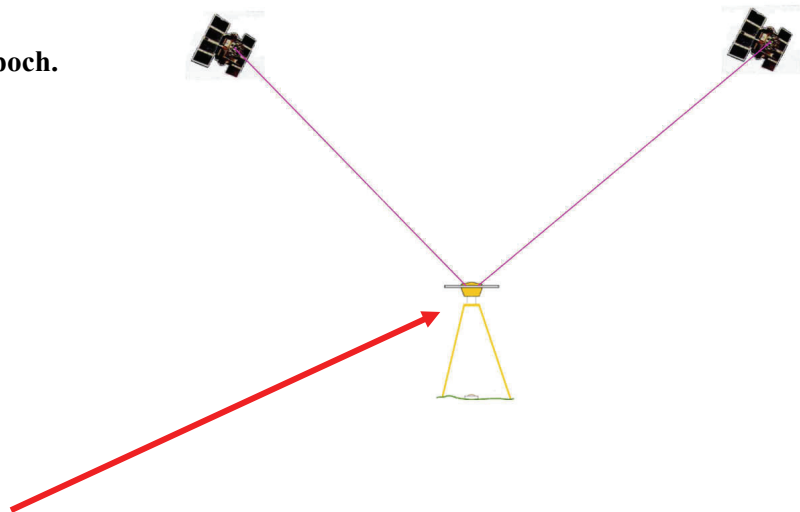

Two satellites, one receiver same epoch,

eliminates receiver clock error,

receiver hardware error

Double-Differenced Phase Solution

$\varphi_{km}^{\rho q}(t) = \varphi_{km}^{\rho}(t) - \varphi_{km}^q(t)$ is the **double difference** observable between SV p and q and Stations k and m at epoch t.

$$\begin{aligned}
 \varphi_{km}^{\rho q}(t) &= \varphi_{km}^{\rho}(t) - \varphi_{km}^q(t) \\
 &= \frac{f}{c} (\rho_k^{\rho}(t) - \rho_m^{\rho}(t)) - f \Delta t_{km}(t) + N_{km}^{\rho} - I_{km,\rho}^{\rho}(t) + \frac{f}{c} T_{km}^{\rho}(t) + d_{km,\rho}(t) + d_{km,\rho}^{\rho}(t) + \varepsilon_{km,\rho}^{\rho} \\
 &\quad - \left(\frac{f}{c} (\rho_k^q(t) - \rho_m^q(t)) - f \Delta t_{km}(t) + N_{km}^q - I_{km,\rho}^q(t) + \frac{f}{c} T_{km}^q(t) + d_{km,\rho}(t) + d_{km,\rho}^q(t) + \varepsilon_{km,\rho}^q \right) \\
 &= \frac{f}{c} (\rho_k^{\rho}(t) - \rho_m^{\rho}(t) - \rho_k^q(t) + \rho_m^q(t)) - \left[\cancel{d_{km,\rho}^{\rho}(t)} - \cancel{d_{km,\rho}^q(t)} \right] + (N_{km}^{\rho} - N_{km}^q) - (I_{km,\rho}^{\rho}(t) - I_{km,\rho}^q(t)) \\
 &\quad + \frac{f}{c} (T_{km}^{\rho}(t) - T_{km}^q(t)) + \left[\cancel{d_{km,\rho}(t)} - \cancel{d_{km,\rho}(t)} \right] + (d_{km,\rho}^{\rho}(t) - d_{km,\rho}^q(t)) + (\varepsilon_{km,\rho}^{\rho} - \varepsilon_{km,\rho}^q) \\
 &= \frac{f}{c} (\rho_k^{\rho}(t) - \rho_m^{\rho}(t) - \rho_k^q(t) + \rho_m^q(t)) + N_{km}^{\rho q} - (I_{km,\rho}^{\rho q}) + \frac{f}{c} (T_{km}^{\rho q}(t)) + d_{km,\rho}^{\rho q}(t) + \varepsilon_{km}^{\rho q}
 \end{aligned}$$

Now the receiver clock errors and hardware delays cancel.

DOUBLE DIFFERENCE – 2 SVNS / 2 RECEIVERS / 1 EPOCH

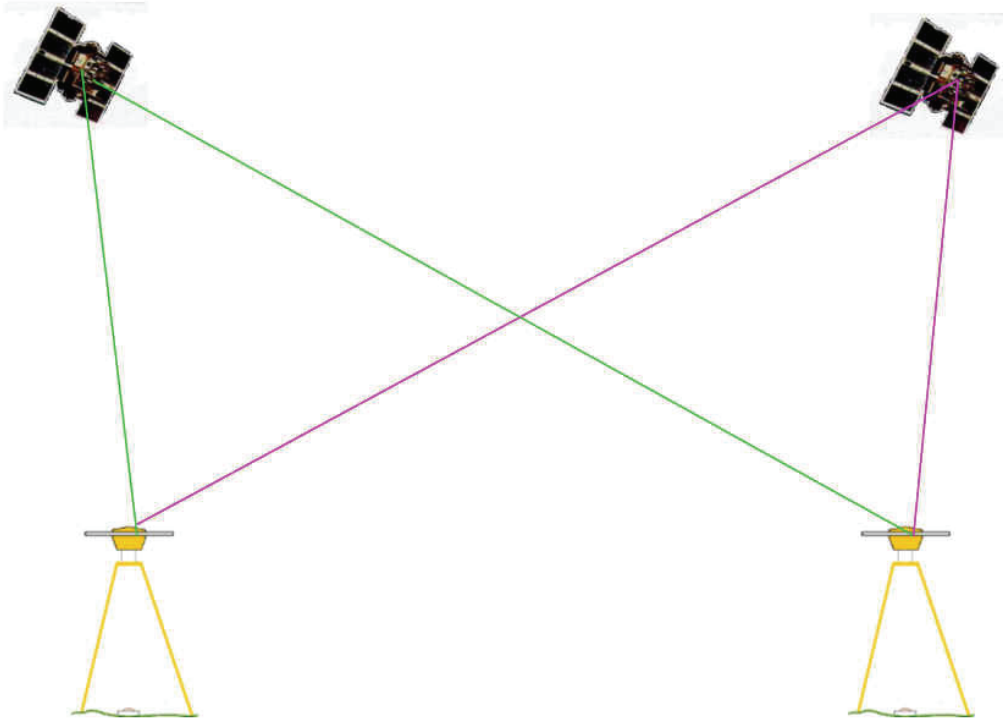

Double differencing: two receivers, two satellites, same epoch (two Single Differences). Eliminates receiver clock error, receiver hardware error, reduces other errors

Triple-Differenced Phase Solution

A **triple difference** observable is the difference between two **double difference** observables for successive epochs.

$\varphi_{km}^{pq}(t_2, t_1) = \varphi_{km}^{pq}(t_2) - \varphi_{km}^{pq}(t_1)$ is the triple difference between SV p and q and Stations k and m at epoch t_2 and epoch t_1 .

$$\varphi_{km}^{pq}(t_1) = \frac{f}{c} (\rho_k^p(t_1) - \rho_m^p(t_1) - \rho_k^q(t_1) + \rho_m^q(t_1)) + N_{km}^{pq}$$

$$\varphi_{km}^{pq}(t_2) = \frac{f}{c} (\rho_k^p(t_2) - \rho_m^p(t_2) - \rho_k^q(t_2) + \rho_m^q(t_2)) + N_{km}^{pq}$$

$$\begin{aligned} \varphi_{km}^{pq}(t_2, t_1) &= \frac{f}{c} (\rho_k^p(t_2) - \rho_m^p(t_2) - \rho_k^q(t_2) + \rho_m^q(t_2)) + N_{km}^{pq} \\ &\quad - \left(\frac{f}{c} (\rho_k^p(t_1) - \rho_m^p(t_1) - \rho_k^q(t_1) + \rho_m^q(t_1)) + N_{km}^{pq} \right) \\ &= \frac{f}{c} (\rho_k^p(t_2) - \rho_k^p(t_1) - \rho_m^p(t_2) + \rho_m^p(t_1) - \rho_k^q(t_2) + \rho_k^q(t_1) + \rho_m^q(t_2) - \rho_m^q(t_1)) \\ &\quad + \cancel{N_{km}^{pq}} - \cancel{N_{km}^{pq}} \quad \text{Cancels Double Difference integer cycles} \\ &= \frac{f}{c} (\rho_k^p(t_2) - \rho_k^p(t_1) - \rho_m^p(t_2) + \rho_m^p(t_1) - \rho_k^q(t_2) + \rho_k^q(t_1) + \rho_m^q(t_2) - \rho_m^q(t_1)) \end{aligned}$$



TRIPLE DIFFERENCE – DOUBLE DIFFERENCES ON 2 EPOCHS

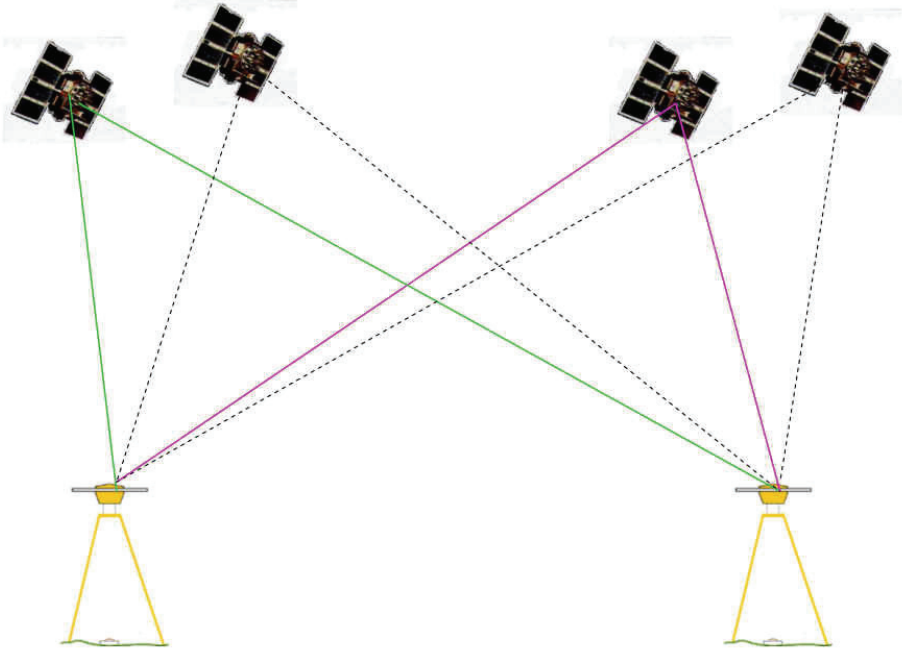

Triple difference – difference of two double differences at two epochs for two satellites and two receivers

If the receiver retains lock between epochs, the double difference ambiguity remains the same for each epoch and therefore will cancel out in the triple difference equation. If the receiver loses lock, the triple difference solution that contains that loss of lock will show as an outlier and therefore will show the cycle slip during processing.

RESULTING DIFFERENCED PHASE OBSERVABLE (CYCLES)

$$\varphi_k^p(t) = \frac{f}{c} \rho_k^p(t) - \int_{t_0}^t \dot{a}_{k,p}(t) dt - f \Delta t_k^p(t) - I_{k,p}^p(t) - I_{k,p}^g(t) + \frac{f}{c} T_k^p(t) + \dot{a}_{k,p}(t) + d_{k,p}^p(t) - \dot{a}_{k,p}^g(t) + \varepsilon_p$$

Superscripts refer to the satellite, subscripts refer to ground station

**LEAVES MULTIPATH,
MEASUREMENT NOISE
& RANGE TO
SATELLITE**

**ASSUMED THE SAME FOR
ROVER & BASE**

Number of Cycles x wave length = distance to satellite.

Variance – covariance matrices are formed from the double differenced ambiguities. The best candidates are established for the integer cycle solution. Pseudorange measurements and frequency combinations such as wide laning and narrow laning and Kalman filtering are some methods that are used to solve the ambiguities through iterative least squares solutions.

Some factors influencing the reliability of Ambiguity Resolutions are:

- Baseline Length
- GDOP - satellite-receiver geometry
- Residual Atmospheric and orbit errors
- Multipath

- Cycle slips
- Search strategy algorithms
- Rising/setting satellites
- Round off integers

Statistically, the ratio of the best to next best solution is constantly monitored in conjunction with change or increase in the RMS. This then gives assurance of the correct ambiguity resolution as the session proceeds after initialization to a fixed solution. Most major GNSS hardware/software manufacturers give their ambiguity resolution confidence at 99.9 percent.

Appendix C

Adjusting the Circular Level Vial

From SECO (http://www.surveying.com/tech_tips/details.asp?techTipNo=13):

ADJUSTMENT OF THE CIRCULAR VIAL:

1. Set up and center bubble as precisely as possible.
2. Rotate center pole 180 degrees. If any part of the bubble goes out of the black circle adjustment is necessary.
3. Move quick release legs until bubble is half way between position one and position two.
4. With a 2.5 mm allen wrench turn adjusting screws until bubble is centered. Recommended procedure is to tighten the screw that is most in line with the bubble. Caution: very small movements work best.
5. Repeat until bubble stays entirely within circle.

A rover pole with an adjusted **standard 40 minute vial** located about midpoint of the length should introduce a maximum leveling error of no more than 2.5 mm (less than 0.01 feet). It should be noted that 10 minute vials are available.

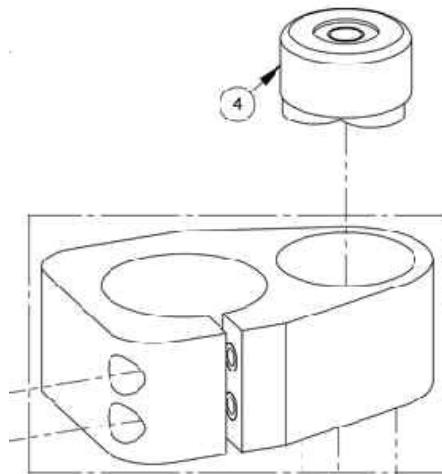

Diagram II-1 - Typical circular vial assembly for the Rover pole

Appendix D

On Determining Survey Project Coordinates and Heights

**Contributed by Michael Dennis, RLS., PE. Chair AAGS Government Programs
Committee**

(Mr. Dennis's text is offered here as a counterpoint to the standard procedure of using GNSS manufacturer's software in field and office routines that provide a quick and easy methodology to constrain local passive monumentation – either horizontally, vertically or with both components. While these built in algorithms are proven techniques that work well for a project area, they essentially comprise a non-geodetic path for the result. It is felt that a valid geodetic transformation routine could provide a better solution if users would become familiar with the concepts and techniques. Mr. Dennis echoes many other geospatial professionals who would like to see this alternative more widely used, and his case is made here to reflect the committee's view and to shed light on this alternative- W.E.H.)

GNSS is a strictly geodetic tool. Once the $\Delta X, \Delta Y, \Delta Z$ ECEF vector from the base to the rover had been computed, the RT GNSS operation is done. Although there is now an X, Y, Z coordinate at the point occupied by the rover that is not normally the final desired product. The geospatial professional using RT GNSS usually wants something else, such as projected (grid) coordinates, so that a map of the results can be made, along with perhaps “elevations” (such as NAVD 88 orthometric heights). The purpose of this commentary is to dispel the persistent myth that a “calibration” or “localization” is required to generate such desired coordinates and “elevations” (this belief is especially strong if the system is considered “local”). There is more than one approach to this problem, and I believe the “calibration/localization” approach is usually *not* the optimal approach.

First, I think it is appropriate to briefly discuss the purpose of guidelines. Guidelines should promote *best practices*, and not merely echo the status quo. And, even if it turns out that such standard existing practice is the best approach, the impression should not be given that it is the only approach

The second task is to define what, exactly, “calibration/localization” means. This is a source of tremendous confusion, which is not helped by the increasing opacity of software. Within the draft guidelines, a site calibration has been promoted as a quick means for transforming from “WGS 84” to a local “datum” using a 7-parameter (Helmert) similarity transformation, which is a geodetic operation, a type of 3D datum transformation. But, in reality a site calibration instead decomposes into two separate horizontal and vertical operations, and either can be performed without the other.

The horizontal calibration is a 4-parameter (conformal) similarity transformation that is performed on projected (grid) coordinates, not on geodetic coordinates. In other words, it is a purely planar (non-geodetic) operation. What this means is that before the calibration can be performed, the “WGS 84” geodetic coordinates must first be projected. For the typical workflow where a “local” coordinate system is desired, the software typically computes a Transverse Mercator (TM) projection with its central meridian through the first point in the calibration list. The TM projection central meridian is scaled (presumably to “ground”) based on a project height entered by the user, which has nothing whatsoever to do with the calibration points (if the project height is zero, the central meridian is one and the TM is tangent to the reference ellipsoid). Then, the northings and eastings based on this projection are transformed to best match the calibration points, which also are stored as northings and eastings. This is done via a best-fit unweighted least squares planar rotation, translation, and scale. Later I will go over the implications of this.

(Formally, a datum transformation is also performed from “WGS 84” to some “local” datum, such as NAD 83, prior to projecting. But this transformation has nothing to do with the calibration, and is performed prior to and completely independently of the calibration. For some vendors, the WGS 84 / NAD 83 transformation is a zero “do nothing” transformation, and for others it is a non-zero one locked to a specific time, usually 1997.0.)

The vertical calibration is quite different. For a single point, it is merely a constant vertical shift. For multiple vertical calibration points, a planar correction surface is computed using unweighted least squares. If a geoid model is used, this surface is based on the ortho height after the geoid model is applied; otherwise it is applied directly to the ellipsoid heights. It’s important to note that this is a planar correction surface (a tilted plane), and not a reference plane *per se*. That is, it is a model that applies a vertical correction value that varies linearly with horizontal position, and its mathematical description is of the same form as the equation for a Euclidian plane.

That pretty much summarizes what horizontal and vertical calibrations are. So what are the implications?

Disadvantages with calibration/localization:

1. ***It increases complexity of a coordinate system definition without improving performance.*** In a vast majority of applications, the horizontal calibration is completely unnecessary for defining a coordinate system, local or otherwise. Yet the mistaken belief persists among most surveyors that you must calibrate in order to get local coordinates.
2. ***It decreases data transferability.*** The use of local coordinate systems based on calibrations (especially horizontal calibrations) is probably the main reason why it is so difficult to get survey data into GIS. What a pity! Such data are potentially extremely valuable, and yet they cannot easily be used in GIS simply because of an unnecessary and

misguided workflow. The reason they cannot be used is that post-projection rotation, translation, and scaling of coordinates is not supported in GIS. And it should not be supported, because it is an unnecessary thing to do. Horizontal calibration essentially “breaks” the data, and makes it much less useful to others.

3. ***It makes it difficult (and at times impossible) to separate out error or distortion sources.*** Everything is bundled together: The measurement error of the calibration grid coordinates, the projection distortion of the calibration grid coordinates, and the measurement error of the observed “WGS 84” coordinates all contribute to the computed parameters and the residuals. ***You can’t tell what error is due to what source.***
4. ***It is not a geodetic operation,*** so it is generally not an appropriate method for making a survey match geodetic control. The problem is that it is a planar operation, and so part of the error budget in the calibration is due to map projection distortion, an effect which increases with the size of the area used (however, this is not a problem if the same projection is used for both the observed “WGS 84” positions and the calibration grid coordinates). It is in addition an unweighted operation based only on coordinate values. The best approach by far is to perform an appropriately weighted least squares ***adjustment of redundant GNSS vectors.***
5. ***When calibrations are used, too much emphasis is placed on inspecting only the residuals for evaluation.*** Beware: ***Small residuals do not guarantee good results.*** It is important to also evaluate the scale of the horizontal calibration, and the slope of the vertical calibration. If NGS is going to promote calibration, guidance should be given on what to look for (and why) in the horizontal scale and planar correction surface slope. But these are not easy things to generalize.

Advantages with calibration/localization

1. ***It’s easy.*** While easy is laudable, it’s a bit of a mirage, for two reasons: 1) It’s also easy to fool yourself and unwittingly end up with profoundly erroneous results, and 2) it’s only easy for the person doing the calibration. Other data users downstream suffer, because it’s more complicated than it needs to be, and it’s non-standard (currently you absolutely cannot get a horizontally calibrated local coordinate system into ESRI GIS without error).

Now we need to return to the original question: Should we encourage people to calibrate/localize? Let’s not lose sight of the real objective here, and that is to generate coordinates and heights useful to surveyors and their clients, and to do so in a reasonably simple (and hopefully standardized) way. To answer this, horizontal and vertical calibrations need to be considered separately.

My opinion is that horizontal calibrations are needed only very rarely. The ***only*** time that I use them (for defining coordinate systems) is when I have to match a set of undefined coordinates, say for a construction staking job where I must match the plans (and even then I try to get as close as possible using rigorously defined standard projections). The only other time I use them is as “throwaway” calibrations for searching for points in the field, such as PLSS corners keyed

in from a plat. They are quite useful for that, but disposable. The 4-parameter similarity transformation can be a very useful tool, and it should be part of every surveyor's tool kit, and not just for calibrating. I often use this transformation to "anticalibrate", that is, to make record surveys match my (rigorously defined) coordinate system. That seems more logical to me. And how could there be a better alternative if there are multiple surveys of record? You can only calibrate to one. Which one?

Vertical calibrations are a different story. A high-resolution hybrid geoid model, such as GEOID03, combined with an accurate NAD 83 ellipsoid height will almost never match the published orthometric height of a station, whether it was determined from differential leveling or an NGS Height Modernization Survey. So, in order to match a benchmark (which is often a project requirement), a simple vertical shift is required, at the minimum. My standard practice is to do only a vertical shift, and then let the geoid model carry the relative orthometric height changes. Even when I have multiple vertical marks, I rarely use a multiple point vertical calibration. Instead, I determine the mean vertical shift that best matches all monuments. Why not use an inclined planar correction surface? In order to avoid the cardinal sin of *creating a definition that increases complexity without improving performance*. What I have found in a vast majority of cases (in Arizona) is that the planar correction surface is at the "noise" level, i.e., at the limit of measurement. When I have ties to several first and second order NGS vertical control stations, the slope of my correction surface is almost always less than 1 ppm. It becomes absurd to use it, because the "improvement" to GPS-derived ortho heights is not even detectable. This leads to some little rules of thumb: If you do a multi-point vertical calibration and the slope of the correction surface exceeds 2 ppm, you should be nervous. If it exceeds 5 ppm, something is probably wrong. If it exceeds 10 ppm, something is definitely wrong (unless it's a small area, say less than a square mile). If you don't use a geoid model, then the slope of the correction surface should match the magnitude and direction of the geoid model slope to the ppm levels cited previously. In other words, use a geoid model (note: these rules likely work well most places in the Lower 48; the situation in Alaska is different).

To summarize, I've basically said that horizontal calibrations are bad, and that vertical calibrations are OK (as long as you don't get too carried away with that inclined planar correction surface business). That leaves a question as to how the surveyor is supposed to generate local "ground" (low-distortion) coordinates. Actually the question is a bit misleading, because a calibration really has nothing to do with generating low-distortion coordinates (or at least it should not be used for that purpose). At present, the major vendors all provide a "push button" approach to generating "ground" coordinates, at least in the office software. This basically consists of scaling an existing coordinate system (such as State Plane) using some user-entered information (such as project height). However, such functionality is not always available in the field (i.e., data collector), and there is a question as to whether it is the best approach anyway.

But rather than attempt to address such a question here, there is a more fundamental question: Should the NGS even be involved in the business of giving guidance on how best to derive “local” coordinates from GNSS? On the one hand, I hear NGS say that projected coordinates really aren’t their responsibility, and/or they don’t have the resources to address the issue. On the other hand, these draft guidelines already try to address such coordinates, and projected coordinates (for SPCS and UTM) are included on datasheets and OPUS output. So there is a bit of inconsistency here. My opinion is that the NGS should address projected coordinates in some way. Presently there is a great deal of confusion on this topic, and people have myriad ways of approaching it, but there is no good standard practice. It seems to me that specifying such best practices is an appropriate role for NGS, and one that could raise its profile without necessarily consuming a lot of resources. And although I believe that NGS should address this issue, it is not clear that it should be addressed in these guidelines. One problem with addressing it in these guidelines is that it is an involved topic, so it could take up a lot of space and thus detract from the goal of providing guidance on using RT GNSS. The other problem is that it is not unique to RT GNSS. So perhaps the best approach would be to address the issue of generating “final” coordinates and heights elsewhere, as separate guidelines. That of course would require additional resources (and time). But it would be better than endorsing vendor-specific workflows and terminology that may not be the best approach. As it stands, in these draft guidelines it appears that “calibration/localization” is being represented as something other than what it actually is, and it’s giving the impression that such an approach is required for RT GNSS projects. I believe there is a better way, which is something I have tried to communicate here.

APPENDIX E

Low Distortion Projections - Michael Dennis, RPLS, PE

What is map projection distortion?

Map projection distortion is an *unavoidable* consequence of attempting to represent a curved surface on a flat surface. It can be thought of as a change in the “true” relationship between points located on the surface of the Earth and the *representation* of their relationship on a plane. Distortion cannot be eliminated — it is a *Fact of Life*. The best we can do is decrease the effect.

There are two general types of map projection distortion:

1. Linear distortion. Difference in distance between a pair of grid (map) coordinates when compared to the true (“ground”) distance, denoted here by δ .
 - Can express as a ratio of distortion length to ground length:
 - E.g., feet of distortion per mile; parts per million (= mm per km).
 - *Note*: 1 foot / mile = 189 ppm = 189 mm / km.
 - Linear distortion can be positive or negative:
 - NEGATIVE distortion means the grid (map) length is SHORTER than the “true” horizontal (ground) length.
 - POSITIVE distortion means the grid (map) length is LONGER than the “true” horizontal (ground) length.
 - Minimizing distortion *only* makes sense for *conformal* projections.
 - For conformal projections (e.g., Transverse Mercator, Lambert Conformal Conic, Stereographic, Oblique Mercator, regular Mercator, etc.), linear distortion is the same in every direction from a point.
 - For *all* non-conformal projections (such as equal area projections), linear distortion generally varies with direction, so there is no single unique linear distortion (or “scale”) at any point.

2. Angular distortion. For conformal projections (e.g., Transverse Mercator, Lambert Conformal Conic, Stereographic, Oblique Mercator, etc.), this equals the *convergence (mapping) angle*, γ . The convergence angle is the difference between grid (map) north and true (geodetic) north.

- Convergence angle is zero on the projection central meridian, positive east of the central meridian, and negative west of the central meridian.
- Magnitude of the convergence angle increases with distance from the central meridian, and its rate of change increases with increasing latitude:

Table 1. Convergence angle at distance of one mile (1.6 km) east (positive) and west (negative) of projection central meridian (for both Transverse Mercator and Lambert Conformal Conic projections).

Latitude	Convergence angle 1 mile from CM	Latitude	Convergence angle 1 mile from CM
0°	0° 00' 00"	50°	±0° 01' 02"
10°	±0° 00' 09"	60°	±0° 01' 30"
20°	±0° 00' 19"	70°	±0° 02' 23"
30°	±0° 00' 30"	80°	±0° 04' 54"
40°	±0° 00' 44"	89°	±0° 49' 32"

- Usually convergence is not as much of a concern as linear distortion, and it can only be minimized by staying close to the projection central meridian (or limiting surveying and mapping activities to equatorial regions of the Earth). Note that the convergence angle is zero for the regular Mercator projection, but this projection is not suitable for large-scale mapping in non-equatorial regions.

Total linear distortion of grid (map) coordinates is a combination of distortion due to Earth curvature and distortion due to ground height above the ellipsoid. In many areas, distortion due to variation in ground height is greater than that due to curvature. This is illustrated in the diagrams and tables on the following pages.

Table 2. Horizontal distortion of grid coordinates due to Earth curvature.

Maximum zone width for secant projections (km and miles)	Maximum linear horizontal distortion, δ		
	Parts per million (mm/km)	Feet per mile	Ratio (absolute value)
25 km (16 miles)	± 1 ppm	± 0.005 ft/mile	1 : 1,000,000
57 km (35 miles)	± 5 ppm	± 0.026 ft/mile	1 : 200,000
81 km (50 miles)	± 10 ppm	± 0.05 ft/mile	1 : 100,000
114 km (71 miles)	± 20 ppm	± 0.1 ft/mile	1 : 50,000
180 km (112 miles)	± 50 ppm	± 0.3 ft/mile	1 : 20,000
255 km (158 miles) e.g., SPCS*	± 100 ppm	± 0.5 ft/mile	1 : 10,000
510 km (317 miles) e.g., UTM [†]	± 400 ppm	± 2.1 ft/mile	1 : 2,500

*State Plane Coordinate System; zone width shown is valid between $\sim 0^\circ$ and 45° latitude

[†]Universal Transverse Mercator; zone width shown is valid between $\sim 30^\circ$ and 60° latitude

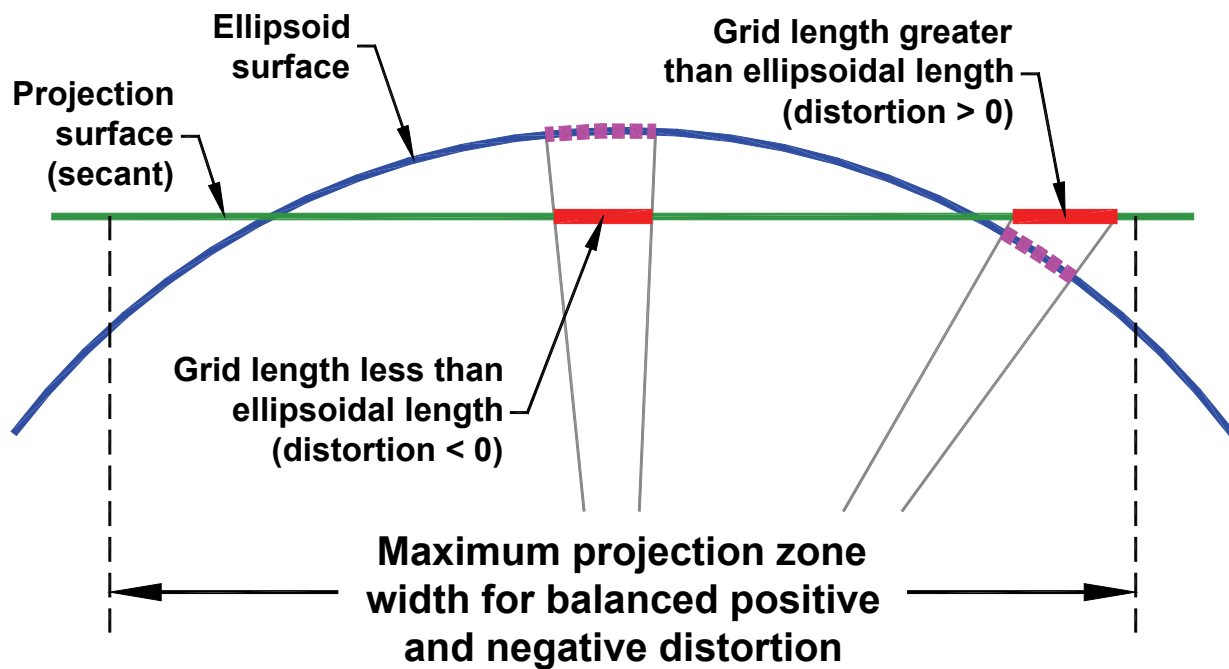

Table 3. Horizontal distortion of grid coordinates due to ground height above the ellipsoid.

Height below (-) and above (+) projection surface	Maximum linear horizontal distortion, δ		
	Parts per million (mm/km)	Feet per mile	Ratio (absolute value)
±30 m (±100 ft)	±4.8 ppm	±0.025 ft/mile	~1 : 209,000
±120 m (±400 ft)	±19 ppm	±0.10 ft/mile	~1 : 52,000
±300 m (±1000 ft)	±48 ppm	±0.25 ft/mile	~1 : 21,000
+600 m (+2000 ft)*	-96 ppm	-0.50 ft/mile	~1 : 10,500
+1000 m (+3300 ft)**	-158 ppm	-0.83 ft/mile	~1 : 6,300
+4400 m (+14,400 ft)†	-688 ppm	-3.6 ft/mile	~1 : 1,500

*Approximate mean topographic height of North America (US, Canada, and Central America)

** Approximate mean topographic height of western coterminous US (west of 100°W longitude)

† Approximate maximum topographic height in coterminous US

Rule of Thumb:

A 30 m (100-ft) change in height causes a 4.8 ppm change in distortion

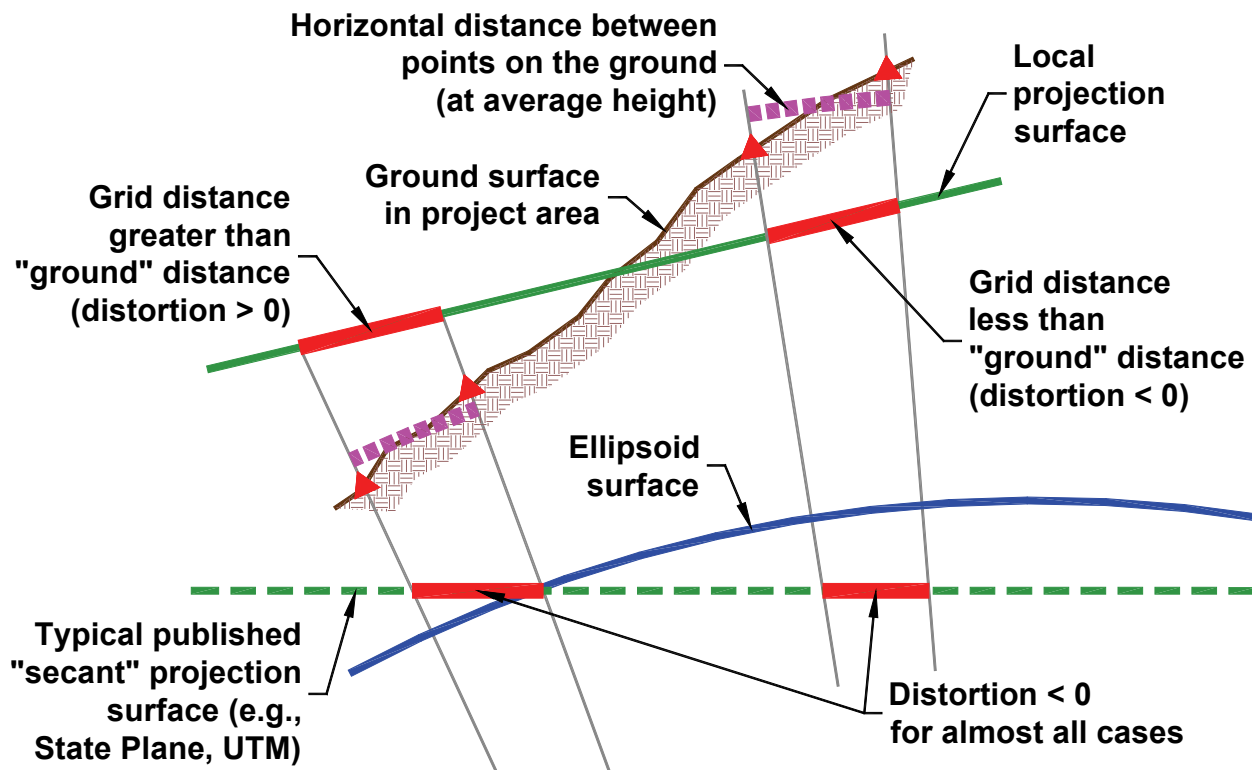

Methods for creating low-distortion grid coordinate systems

1. Design a Low Distortion Projection (LDP) for a specific project geographic area

Use a conformal projection referenced to the existing geodetic datum.

Described in detail later in this document

2. Scale the reference ellipsoid “to ground”

A map projection referenced to this new “datum” is then designed for the project area.

Problems:

- Requires a new ellipsoid (datum) for every coordinate system, which makes it more difficult to implement than an LDP.
- New datum makes it more complex than an LDP, yet it does not perform any better.
- *Generates new set of latitudes that can be substantially different from original latitudes.*
 - Change in latitude can exceed 3 feet per 1000 ft of topographic height, depending on method used for scaling the ellipsoid (this case is for scaling with constant flattening).
 - Can lead to confusion over which latitude values are correct.

3. Scale an existing published map projection “to ground”

Often referred to as “modified” State Plane when an SPCS projection definition is scaled.

Problems:

- Generates coordinates with values similar to “true” State Plane (can cause confusion).
 - Can eliminate this problem by translating grid coordinates to get smaller values.
- Often yields “messy” parameters when a projection definition is back-calculated from the scaled coordinates (in order to import the data into a GIS).
 - More difficult to implement in a GIS, and may cause problems due to rounding or truncating of “messy” projection parameters (especially for large coordinate values).
 - Can reduce this problem through judicious selection of “scaling” parameters.
- Does **not** reduce the convergence angle (it is same as that of original SPCS definition).
 - In addition, the *arc-to-chord correction* may be significant; it can reach ½ arc-second for a 1-mile line located 75 miles from the projection axis (this correction is used along with the convergence angle for converting grid azimuths to geodetic azimuths).
- **MOST IMPORTANT: Usually does not minimize distortion over as large an area as the other two methods**
 - Extent of low-distortion coverage generally *decreases* as distance *increases* from projection axis (i.e., central meridian for TM and central parallel for LCC projection).
 - State Plane axis usually does NOT pass through the project area.
 - *Sketches illustrating this problem with “modified” SPCS are shown on the next page.*

Local grid coordinate system designed for specific project location, showing extent of low-distortion coverage

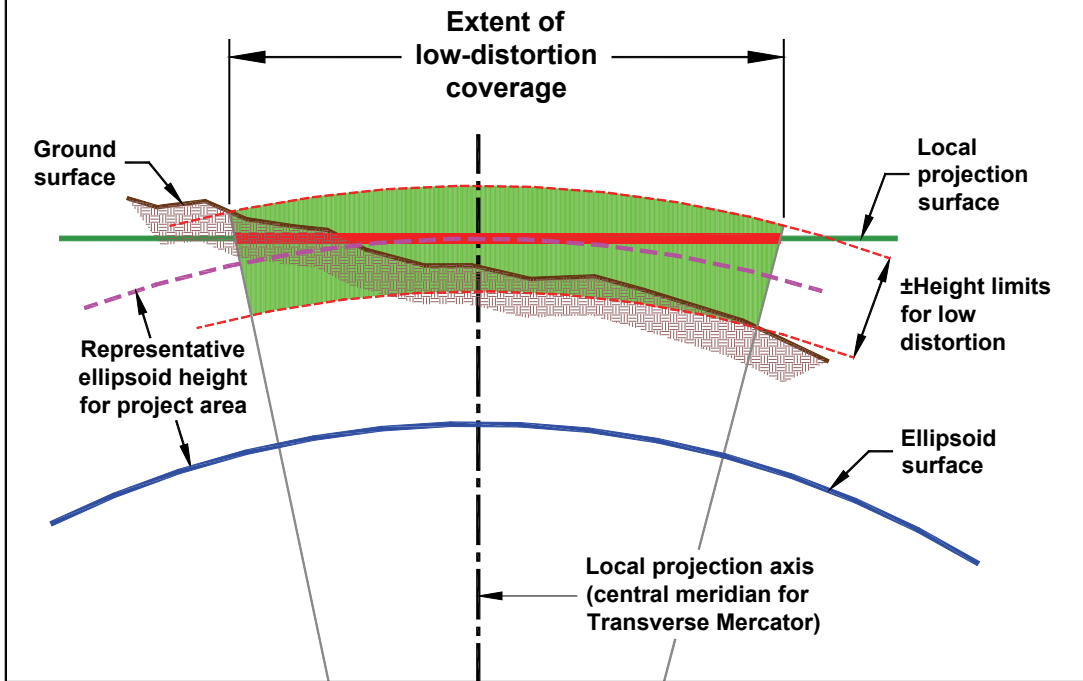

Local grid coordinate system based on "modified" State Plane approach, showing reduced extent of low-distortion coverage

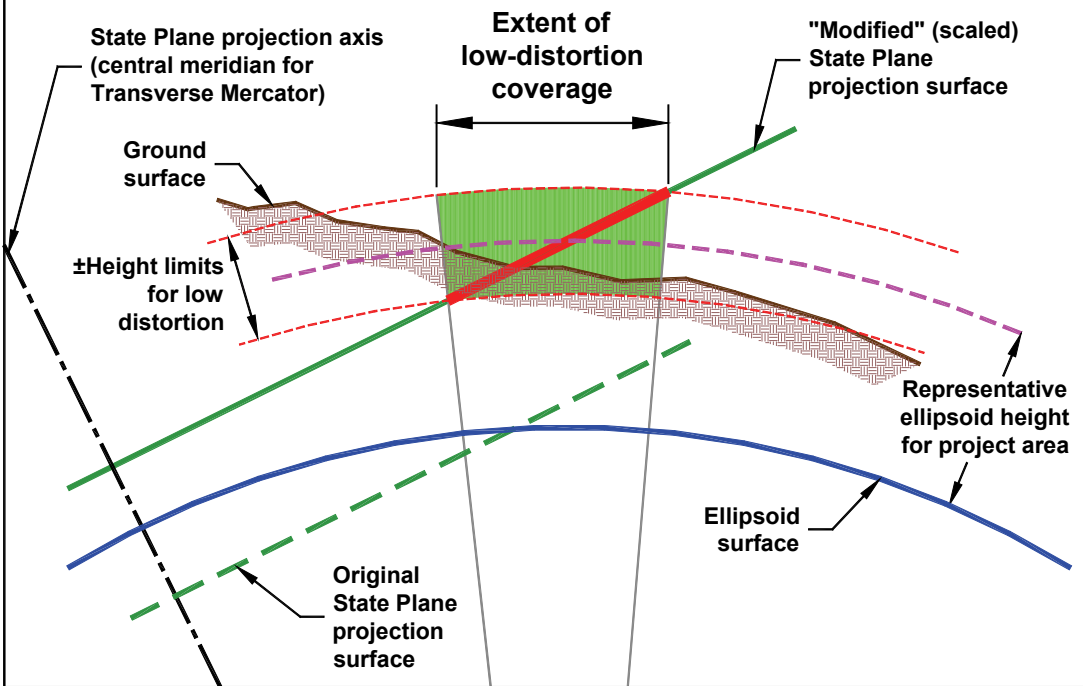

Six steps for designing a Low Distortion Projection (LDP)

1. Define project area and choose *representative* ellipsoid height, h_0 (not elevation)

- The *average* height of an area may not be appropriate (e.g., for projects near a mountain).
 - Usually no need to estimate height to an accuracy of better than about ± 6 m (± 20 ft).
- Note that as the size of the area increases, the effect of Earth curvature on distortion increases, and it must be considered in addition to the effect of topographic height
 - E.g., for areas wider than about 57 km (35 miles) perpendicular to the projection axis (i.e., ~ 29 km or ~ 18 miles either side of projection axis), distortion due to curvature alone exceeds 5 parts per million (ppm). The “projection axis” is defined in step #2.

2. Choose projection type and place projection axis near centroid of project area

- Select a well-known and widely used *conformal* projection, such as the Transverse Mercator (TM), one-parallel Lambert Conformal Conic (LCC), or Oblique Mercator (OM).
 - When minimizing distortion, it will not always be obvious which projection type to use, but for small areas ($< \sim 55$ km or ~ 35 miles wide perpendicular to the projection axis), usually both the TM and LCC will provide satisfactory results.
 - When in doubt, the TM is a good choice for most applications, since it is probably the map projection supported across the broadest range of software packages. However, commercial software vendors are adding more user-definable projections, and so over time the problem of projection availability should diminish.
 - In nearly all cases, a two-parallel LCC should *not* be used for an LDP with the NAD 83 datum definition (but note that some software may not support a one-parallel LCC). A two-parallel LCC should not be used because the reason there are two parallels is to make the projection secant to the ellipsoid (i.e., the central parallel scale is less than 1). This is at odds with the usual objective of scaling the projection so that the developable surface is at the topographic surface, which is typically above the ellipsoid, particularly in areas where reduction in distortion is desired.
 - The OM projection can be very useful for minimizing distortion over large areas, especially areas that are more than about 55 km (35 miles) long in an oblique direction. It can also be useful in areas where the topographic slope varies gradually and more-or-less uniformly in a direction other than north-south or east-west. The disadvantage of this projection is that it is more difficult to evaluate, since another parameter must be optimized (the projection skew axis). In addition, this projection is more complex, and may not be available in as many software packages as the TM and LCC.

- The Oblique Stereographic (OS) projection can also provide satisfactory results for small areas, but it has the disadvantage of not conforming to Earth curvature in any direction. In situations where this projection works well, there really is no reason to use it, because the TM projection will give equally good (if not better) results. In very rare cases this projection might give the best results, such as bowl-shaped areas.
- Bear in mind that universal commercial software support is not an essential requirement for selecting a projection. In the rare cases where third parties must use a coordinate system based on a projection not supported in their software, it is always possible for them to get on the coordinate system implicitly (i.e., using a best-fit procedure based on coordinate values).
- “Projection axis” is the line along which projection scale is constant (with respect to the ellipsoid). It is the central meridian for the TM projection, the standard (central) parallel for the one-parallel LCC projection, the (implicitly defined) central parallel for the two-parallel LCC projection, and the skew axis for the OM projection. The OS projection does not have a projection axis (projection scale is only constant at one point).
 - Place the central meridian of the projection near the east-west “middle” of the project area in order to minimize convergence angles (i.e., the difference between geodetic and grid north).
- In some cases it may be advantageous to offset the projection axis from project centroid (e.g., if topographic height increases gradually and more-or-less uniformly with distance from the projection axis).

3. Scale central meridian of projection to representative ground height, h_0

- Compute map projection axis scale factor “at ground”: $k_0 = 1 + \frac{h_0}{R_G}$
 - For TM projection, k_0 is the central meridian scale factor
 - For one-parallel LCC projection, k_0 is the standard (central) parallel scale factor
- R_G is the geometric mean radius of curvature, $R_G = \frac{a\sqrt{1-e^2}}{1-e^2 \sin^2 \varphi}$

and φ = geodetic latitude of point, and for the GRS-80 ellipsoid:

$$a = \text{semi-major axis} = 6,378,137 \text{ m (exact)} = 20,925,646.325 \text{ international ft}$$

$$= 20,925,604.474 \text{ US survey ft}$$

$$e^2 = \text{first eccentricity squared} = 2f - f^2$$

$$f = \text{geometric flattening} = 1 / 298.257222101$$

- Alternatively, can initially approximate R_G since k_0 will likely be refined in Step #4:

Table 4. Geometric mean radius of curvature at various latitudes for the GRS-80 ellipsoid (rounded to nearest 1000 meters and feet).

Latitude	R_G (meters)	R_G (feet)	Latitude	R_G (meters)	R_G (feet)
0°	6,357,000	20,855,000	50°	6,382,000	20,938,000
10°	6,358,000	20,860,000	60°	6,389,000	20,961,000
20°	6,362,000	20,872,000	70°	6,395,000	20,980,000
30°	6,367,000	20,890,000	80°	6,398,000	20,992,000
40°	6,374,000	20,913,000	90°	6,400,000	20,996,000

4. Check distortion at points distributed throughout project area

- Best approach is to compute distortion over entire area and generate distortion contours (this ensures optimal low-distortion coverage).
 - May require repeated evaluation using different k_0 values.
 - May warrant trying different projection axis locations and different projection types.
- Distortion computed at a point (at ellipsoid height h) as $\delta = k \left(\frac{R_G}{R_G + h} \right) - 1$
 - Where k = projection grid point scale factor (i.e. “distortion” with respect to ellipsoid at a specific point). Note that computation of k is rather involved, and is often done by commercially available software. However, if your software does not compute k , or if you want to check the accuracy of k computed by your software, equations for doing so for the TM and LCC projections are provided later in this document.
 - Multiply δ by 1,000,000 to get distortion in parts per million (ppm).

5. Keep the definition SIMPLE and CLEAN!

- Define k_0 to no more than SIX decimal places, e.g., 1.000206 (exact).
 - *Note:* A change of one unit in the sixth decimal place equals distortion caused by a 6.4-meter (21-foot) change in height.
- Defining central meridian and latitude of grid origin to nearest whole arc-minute is usually adequate (e.g., central meridian = 111°48’00” W).

- Define grid origin using whole values with as few digits as possible (e.g., false easting = 50,000 for a system with maximum easting coordinate value < 100,000). Note that the grid origin definition has no effect whatsoever on the map projection distortion.
 - It is strongly recommended that the coordinate values everywhere in the design area be distinct from other coordinate system values for that area (such as State Plane or UTM) in order to reduce the risk of confusing the LDP with other systems.
 - *Note:* In some applications, there may be an advantage to using other criteria for defining the grid origin. For example, it may be desirable for all coordinates in the design area to have the same number of digits (such as six digits, i.e., between 100,000 and 999,999). In other cases it may be useful to make the coordinates distinct from State Plane by using larger rather than smaller coordinates, especially if the LDP covers a very large area.

6. **Explicitly define linear unit and geometric reference system (i.e., geodetic datum)**

- E.g., Linear unit = international foot; Geometric reference system = NAD 83 (2007).
 - The international foot is shorter than the US survey foot by 2 ppm. Because coordinate systems typically use large values, it is critical that the type of foot used be identified (the values differ by 1 foot per 500,000 feet).
- *Note:* The reference system realization (i.e., “datum tag”) is not an essential component of the coordinate system definition. However, the datum tag is an essential component for defining the spatial data used within the coordinate system. This is shown in a metadata example later in this document. For NAD 83, the NGS convention is to give the datum tag in parentheses after the datum name, usually as the year in which the datum was “realized” as part of a network adjustment. Common datum tags are listed below:
 - “2007” for the current NSRS2007 (National Spatial Reference System of 2007) realization.
 - “199x” for the various HARN (or HPGN) realizations, where *x* is the last digit of the year of the adjustment (usually done for a particular state). For example, the HARN/HPGN adjustment for Arizona was done in 1992, so its datum tag is “1992”. The HARN and HPGN abbreviations are equivalent, and they stand for “High Accuracy Reference Network” and “High Precision Geodetic Network”.
 - “CORS” for the realization based on the CORS network, and currently corresponding to 2002.00 for the coterminous US and Hawaii (and 2003.00 in Alaska).
 - “1986” for the original NAD 83 realization. Because of the coordinate changes that occurred as part of the HARN/HPGN and NSRS2007 readjustments, this realization is not appropriate for data with horizontal accuracies of better than about 1 meter.

Example LDP computations

Design a Low Distortion Projection (LDP) for: Cochise County

1. Define project area and choose *representative* ellipsoid height, h_0 (not elevation)

From National Elevation Dataset and GEOID03 model, mean value for Cochise County is approximately $h_0 = \underline{4550 \text{ ft}}$

2. Choose projection type and place projection axis near centroid of project area

After some preliminary evaluation, a Transverse Mercator projection was selected, so the projection axis is the central meridian. Based on the location and east-west extent of the county, a good, clean value for the central meridian is $\lambda_0 = \underline{109^\circ 45' 00'' \text{ W}}$

3. Scale central meridian of projection to representative ground height, h_0

First compute Earth radius at mid-latitude of $\varphi = \underline{31^\circ 50' 00'' \text{ N}}$ (no need for greater accuracy than nearest arc-minute of latitude):

$$R_G = \frac{a\sqrt{1-e^2}}{1-e^2 \sin^2 \varphi} = \frac{20,925,646.325 \times \sqrt{1-0.006694380023}}{1-0.006694380023 \times [\sin(31.833333^\circ)]^2} = \underline{20,894,400 \text{ ift}}$$

Thus the central meridian scale factor scaled to the representative ellipsoid height is

$$k_0 = 1 + \frac{h_0}{R_G} = 1 + \frac{4550}{20,894,400} = \underline{1.000218}$$

Based on these results, the following Transverse Mercator projection is defined (will refine definition if necessary based on results of Step #4):

Latitude of grid origin: south of Mexican border)	$\varphi_0 = 31^\circ 15' 00'' \text{ N}$ (clean number
Central meridian:	$\lambda_0 = 109^\circ 45' 00'' \text{ W}$
False northing:	$N_0 = 0.000 \text{ ift}$
False easting: number for midpoint)	$E_0 = 250,000.000 \text{ ift}$ (clean
Central meridian scale:	$k_0 = 1.000218$

4. Check distortion at points distributed throughout project area

Distortion was checked by computing values on a regular grid over the entire county. It was found that the mean distortion over the county based on the average ellipsoidal height was too large (approximately +20 ppm) because of the effect of Earth curvature.

Example computations of distortion at specific points are provided for two NGS control stations with similar ellipsoidal heights (values rounded to nearest foot):

$$\text{RASO 2 (CY0421): } \varphi_0 = 32^\circ 20' 58.00'' \text{ N, } \lambda_0 = 109^\circ 44' 28.34'' \text{ W, } h = 4327 \text{ ft}$$

$$\text{LOBO (DH5758): } \varphi_0 = 31^\circ 43' 50.75'' \text{ N, } \lambda_0 = 110^\circ 21' 03.34'' \text{ W, } h = 4303 \text{ ft}$$

Linear distortion is computed as $\delta = k \left(\frac{R_G}{R_G + h} \right) - 1$. For the initial LDP design we have:

$$\text{RASO 2: } \delta = 1.00021801 \times \left(\frac{20,895,537}{20,895,537 + 4327} \right) - 1 = 1.00001092 - 1 = \underline{\underline{+10.9}}$$

ppm

$$\text{LOBO: } \delta = 1.00025799 \times \left(\frac{20,894,176}{20,894,176 + 4303} \right) - 1 = 1.00005203 - 1 = \underline{\underline{+52.0}}$$

ppm

Because of the excessive positive distortion, the value of k_0 was decreased to achieve better low distortion coverage over the entire county. After some analysis, a value of $k_0 = 1.000195$ was selected. The linear distortion at the example NGS stations becomes:

$$\text{RASO 2: } \delta = 1.00019501 \times \left(\frac{20,895,537}{20,895,537 + 4327} \right) - 1 = 0.99998793 - 1 = \underline{\underline{-12.1}}$$

ppm

$$\text{LOBO: } \delta = 1.00023499 \times \left(\frac{20,894,176}{20,894,176 + 4303} \right) - 1 = 1.00002904 - 1 = \underline{\underline{+29.0}}$$

ppm

In addition, it was decided to move the latitude of grid origin further north to $\varphi_0 = 31^\circ 19' 00'' \text{ N}$ (closer to the Mexican border), and to decrease the false easting slightly to $E_0 = 240,000.000 \text{ if}$ (note that the false northing and easting values have NO effect on distortion, nor does the latitude of grid origin for the Transverse Mercator projection).

5. Keep the definition SIMPLE and CLEAN!

All of the projection parameters were initially defined in Step #3, but were refined to the following values:

- k_0 defined to *exactly* SIX decimal places: $k_0 = 1.000195$ (exact)
- Both latitude of grid origin and central meridian are defined to nearest whole arc-minute:

$$\varphi_0 = 31^\circ 19' 00'' \text{ N} = 31.316666666667^\circ \quad \text{and} \quad \lambda_0 = 109^\circ 45' 00'' \text{ W} \\ = -109.75^\circ$$

φ_0 was selected far enough south to ensure positive northings, but far enough north to minimize northings.

- Grid origin is defined using clean whole values with as few digits as possible:

$$N_0 = 0.000 \text{ ift} \quad \text{and} \quad E_0 = 240,000.000 \text{ ift}$$

These values were selected to keep grid coordinates positive but as small as possible in Cochise County (and thus distinct from State Plane and UTM values)

6. Explicitly define linear unit and geometric reference system (i.e., geodetic datum)

- Linear unit is **International foot**, and geometric reference system is **NAD 83 (2007)**
- The final projection parameters, linear unit, and geodetic datum can be used directly to create a coordinate system definition that is compatible with most GIS and surveying software. For example, this can be done for ESRI software by using ArcCatalog to create a projection file (*.prj), or for Trimble software by using Coordinate System Manager to augment the coordinate system database file (*.csd).

Table 5. Comparison of Cochise County LDP parameters to State Plane Coordinate System of 1983, Arizona Eastern Zone (SPCS 83 AZ E, 0201) and “equivalent” back-calculated modified SPCS 83 AZ E scaled about projection origin (all linear units are International feet)

Transverse Mercator projection parameters	Cochise County LDP	SPCS 83 AZ E	“Equivalent” modified SPCS 83 AZ E
Latitude of grid origin	31°19'00" N	31°00'00" N	31°00'00" N
Longitude of central meridian	109°45'00" W	110°10'00" W	110°10'00" W
Northing at grid origin	0.000 ift	0.000 ift	0.000 ift
Easting at central meridian	240,000.000 ift	700,000.000 ift	700,209.026 020 871... ift
Central meridian scale factor	1.000195 (exact)	0.9999 (exact)	1.000 198 578 740 38...

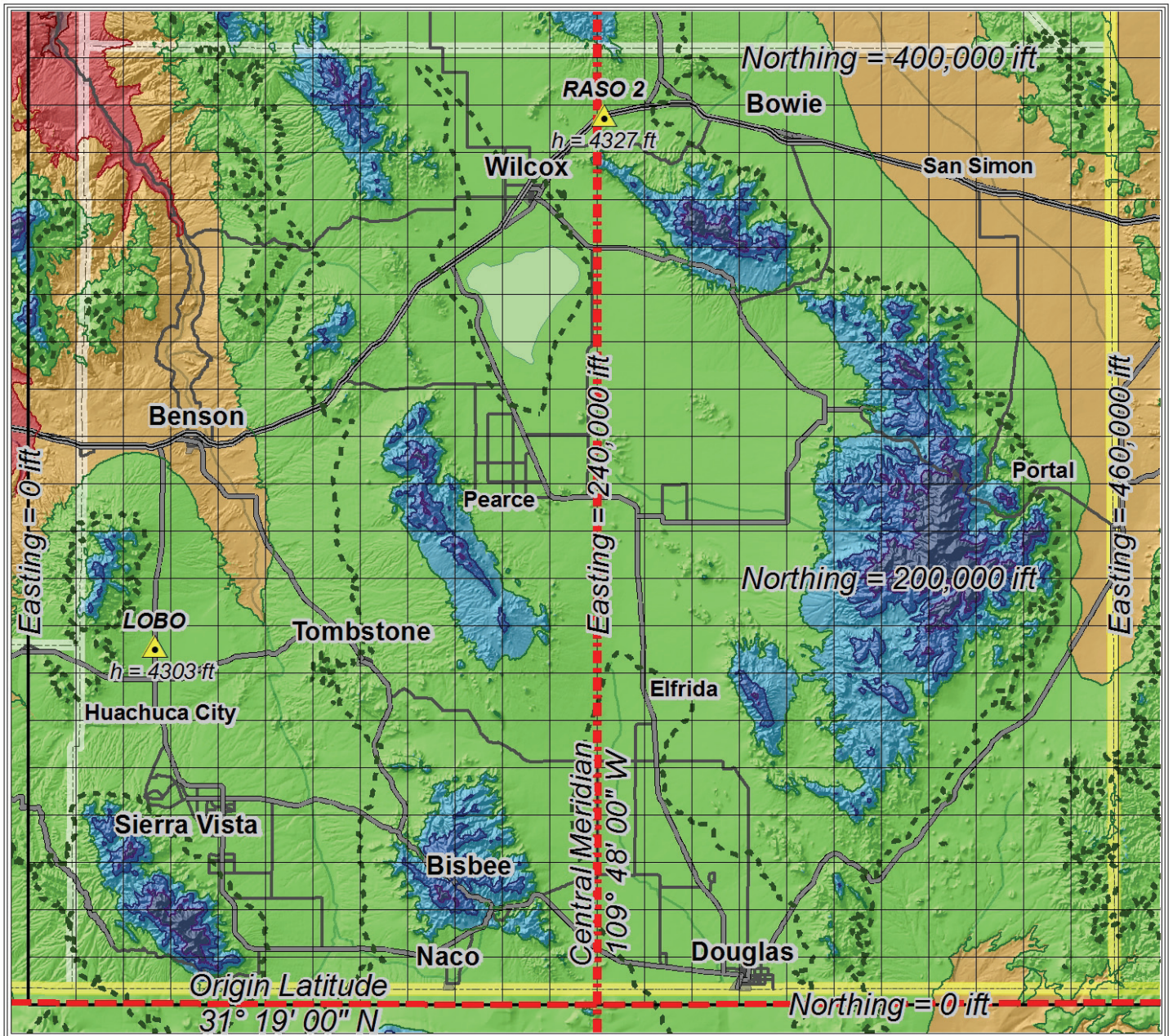

Cochise County, Arizona Low Distortion Projection

Linear unit: International foot
 North American Datum of 1983
 Transverse Mercator projection
 Latitude of origin: 31° 19' 00" N
 Central meridian: 109° 45' 00" W
 False northing: 0.000 ift
 False easting: 240,000.000 ift
 CM scale factor: 1.000195 (exact)

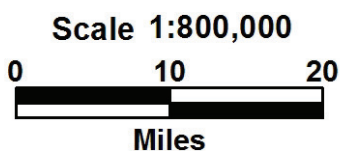

Linear distortion

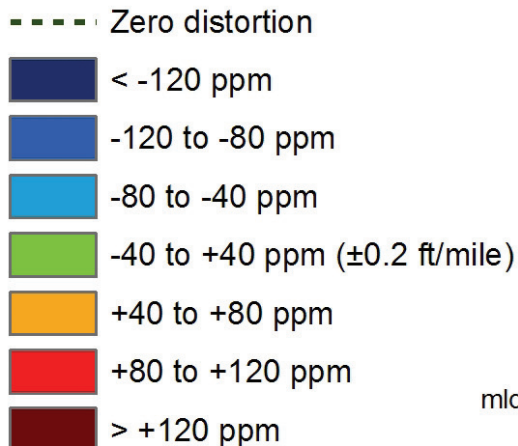

Vicinity Map



Prepared by:
 Geodetic Analysis, LLC
 8775 S Cluff Ranch Rd
 Pima, AZ 85543
 mld@geodeticanalysis.com
 © 2006 Michael L. Dennis

Projection grid point scale factor and convergence angle computation

The projection grid point scale factor, k , is required to compute map projection distortion for a point on the ground. Because some GIS and surveying software does not provide k , formulas for computing it are given below for the Transverse Mercator and Lambert Conformal Conic projections. These were modified from those provided in *NOAA Manual NOS NGS 5 "State Plane Coordinate System of 1983"* by James Stem (1990). Equations for computing the convergence angle of these projections are also provided.

For the *Transverse Mercator* (TM) projection, the grid scale factor at a point can be computed as follows (modified from Stem, 1990, pp. 32-35):

$$k = k_0 \left\{ 1 + \frac{(\Delta\lambda \cos \varphi)^2}{2} \left(1 + \frac{e^2 \cos^2 \varphi}{1 - e^2} \right) \left[1 + \frac{(\Delta\lambda \cos \varphi)^2}{12} \left(5 - 4 \tan^2 \varphi + \frac{e^2 \cos^2 \varphi}{1 - e^2} (9 - 24 \tan^2 \varphi) \right) \right] \right\}$$

where $\Delta\lambda = \lambda_0 - \lambda$ (in radians; note that west longitude is negative)

λ = geodetic longitude of point

λ_0 = central meridian longitude

and all other variables are as defined previously.

The following shorter equation can be used to approximate k for the TM projection. It is accurate to better than 0.02 part per million (at least 7 decimal places) if the computation point is within about $\pm 1^\circ$ of the central meridian (about 80-100 km or 50-60 miles between latitudes of 30° and 45°).

$$k \approx k_0 \left\{ 1 + \frac{(\Delta\lambda \cos \varphi)^2}{2} \left(1 + \frac{e^2 \cos^2 \varphi}{1 - e^2} \right) \right\}$$

Note that this equation may not be sufficiently accurate for computing k throughout a UTM system zone (at the zone width of $\pm 3^\circ$ from the central meridian the error can exceed 1 ppm).

An even simpler equation can be used to approximate the grid scale factor, which utilizes the grid coordinate easting value and is about twice as accurate as the previous equation (i.e., better than 0.01 part per million if the computation point is within about $\pm 1^\circ$ of the central meridian):

$$k \approx k_0 + \frac{(E_0 - E)^2}{2(k_0 R_G)^2}$$

where E = Easting of the point where k is computed (in same units as R_G)

E_0 = False easting (on central meridian) of projection definition (in same units as R_G)

R_G = Earth geometric mean radius of curvature (can estimate using 6,373,000 meters or 20,910,000 feet for coterminous US)

For the **Lambert Conformal Conic** (LCC) projection, the grid scale factor at a point can be computed as follows (modified from Stem, 1990, pp. 26-29):

$$k = k_0 \frac{\cos \varphi_0}{\cos \varphi} \sqrt{\frac{1 - e^2 \sin^2 \varphi}{1 - e^2 \sin^2 \varphi_0}} \exp \left\{ \frac{\sin \varphi_0}{2} \left[\ln \frac{1 + \sin \varphi_0}{1 - \sin \varphi_0} - \ln \frac{1 + \sin \varphi}{1 - \sin \varphi} + e \left(\ln \frac{1 + e \sin \varphi}{1 - e \sin \varphi} - \ln \frac{1 + e \sin \varphi_0}{1 - e \sin \varphi_0} \right) \right] \right\}$$

where k_0 = projection grid scale factor applied to central parallel (tangent to ellipsoid if $k_0 = 1$)

φ_0 = geodetic latitude of central parallel = standard parallel for one-parallel LCC

$e = \sqrt{e^2} = \sqrt{2f - f^2}$ = first eccentricity of the reference ellipsoid

and all other variables are as defined previously. In order to use this equation for a two-parallel LCC, the two-parallel LCC must first be converted to an equivalent one-parallel LCC by computing φ_0 and k_0 . The equations to do this are long, but are provided here for the sake of completeness. For a two-parallel LCC, the central parallel is

$$\varphi_0 = \sin^{-1} \left[\frac{2 \ln \left(\frac{\cos \varphi_S}{\cos \varphi_N} \sqrt{\frac{1 - e^2 \sin^2 \varphi_N}{1 - e^2 \sin^2 \varphi_S}} \right)}{\ln \left(\frac{1 + \sin \varphi_N}{1 - \sin \varphi_N} \right) - \ln \left(\frac{1 + \sin \varphi_S}{1 - \sin \varphi_S} \right) + e \left[\ln \left(\frac{1 + e \sin \varphi_S}{1 - e \sin \varphi_S} \right) - \ln \left(\frac{1 + e \sin \varphi_N}{1 - e \sin \varphi_N} \right) \right]} \right],$$

and the central parallel scale factor is

$$k_0 = \frac{\cos \varphi_N}{\cos \varphi_0} \sqrt{\frac{1 - e^2 \sin^2 \varphi_0}{1 - e^2 \sin^2 \varphi_N}} \times \exp \left\{ \frac{\sin \varphi_0}{2} \left[\ln \left(\frac{1 + \sin \varphi_N}{1 - \sin \varphi_N} \right) - \ln \left(\frac{1 + \sin \varphi_0}{1 - \sin \varphi_0} \right) + e \left(\ln \left[\frac{1 + e \sin \varphi_0}{1 - e \sin \varphi_0} \right] - \ln \left[\frac{1 + e \sin \varphi_N}{1 - e \sin \varphi_N} \right] \right) \right] \right\},$$

where φ_N and φ_S = geodetic latitude of northern and southern standard parallels, respectively, and all other variables are as defined previously.

Convergence angles. For the TM, the convergence angle can be approximated as $\gamma = -\Delta\lambda \sin \varphi$ (where all variables are as defined previously; the units of γ are the same as the units of $\Delta\lambda$). This equation is accurate to better than ± 0.2 arc-second if the computation point is within about $\pm 1^\circ$ of the central meridian. For any LCC, the convergence angle is exactly equal to $\gamma = -\Delta\lambda \sin \varphi_0$.

Surveying & mapping spatial data requirements & recommendations

These should be explicitly specified for surveying and mapping projects

1. Completely define the coordinate system

- a. Linear unit (e.g., international foot, U.S. survey foot, meter).
 - i. Use same linear unit for horizontal and vertical coordinates.
- b. Geometric reference system (i.e., geodetic datum) — recommend North American Datum of 1983 (NAD 83).
 - i. Always include datum “tag” (usually as a year).
 - 1) e.g., 1986, 1992 (HARN), 2002.0 (CORS), 2007, NSRS2007.
 - ii. NAD 27, any realization of WGS 84 or ITRF, and NAD 83 (1986) are **NOT** recommended.
- c. Vertical datum (e.g., North American Vertical Datum of 1988).
 - i. If GPS used for transferring elevations, recommend using a modern high-accuracy geoid model (e.g., GEOID09).
 - ii. Recommend using NAVD 88 rather than NGVD 29 when possible.
- d. Map projection type and parameters (e.g., Transverse Mercator, Lambert Conformal Conic).
 - i. Special attention required for low-distortion grid (a.k.a. “ground”) coordinate systems.
 - 1) Avoid scaling of existing coordinate systems (e.g., “modified” State Plane).

2. Require *direct* referencing of the NSRS (National Spatial Reference System)

- a. Ties to published control strongly recommended (e.g., National Geodetic Survey control).
 - i. Relevant component of control must have greater accuracy than positioning method used.
 - 1) E.g., B-order (or better) stations for GPS control, 2nd order (or better) for vertical control.
 - 2) Note: NGS moving toward a different system for classifying GPS control accuracy using linear units in the north, east, and up (ellipsoid height) components (at 95% confidence). Most of the NGS GPS-derived control utilizes this new accuracy system.
- b. NGS Continuously Operating Reference Stations (CORS) can be used to reference the NSRS.
 - i. Free Internet GPS post-processing service: OPUS (Online Positioning User Service).

3. Specify *accuracy* requirements (*not* precision)

- a. Use objective, defensible, and robust methods (published ones are recommended).
 - i. Mapping and surveying: FGDC National Standard for Spatial Data Accuracy (NSSDA)
 - 1) Require occupations (“check shots”) of known high-quality control stations as a means to evaluate positional accuracy.
 - ii. Surveys performed for establishing control or determining property boundaries:
 - 1) Appropriately constrained and over-determined least-squares adjusted control network.
 - 2) Beware of “cheating” (e.g., using “trivial” GPS vectors in a network adjustment without accounting for the additional false redundancy).

4. Documentation is *essential* (metadata!)

- a. Require a report detailing methods, procedures, and results for developing final deliverables.
 - i. This must include any and all post-survey coordinate transformations.
 - 1) E.g., published datum transformations, computed correction surfaces, “rubber sheeting”, “calibrating/localizing”.
- b. Documentation should be complete enough that someone else can reproduce the product.
- c. For GIS data, recommend that accuracy and coordinate system information be included as feature attributes (not just as separate, easy-to-lose, easy-to-ignore, and often incomplete metadata files).

Example of surveying and mapping documentation (*metadata*)

Basis of Bearings and Coordinates

Linear unit: International foot (ift)

Geodetic datum: North American Datum of 1983 (2007)

Vertical datum: North American Vertical Datum of 1988 (see below)

System: Arizona LDP

Zone: Cochise County

Projection: Transverse Mercator

Latitude of grid origin: 31° 19' 00" N

Longitude of central meridian: 109° 45' 00" W

Northing at grid origin: 0.000 ft

Easting at central meridian: 240,000.000 ift

Scale factor on central meridian: 1.000195 (exact)

All distances and bearings shown hereon are projected (grid) values based on the preceding projection definition. The projection was defined such that projected (grid) distances are equivalent to "ground" distances in the project area.

The basis of bearings is geodetic north. Note that the grid bearings shown hereon (or implied by grid coordinates) do not equal geodetic bearings due to meridian convergence.

Orthometric heights (elevations) were transferred to the site from NGS control station "FLYING" (PID CG1157) using GPS with NGS geoid model "GEOID03" referenced to the current published NAVD 88 height of this station (1357.50 m).

The survey was conducted using GPS referenced to the National Spatial Reference System. A partial list of point coordinates is given below (additional coordinates are available upon request). Local network accuracy estimates are given at the 95% confidence level and are based on an appropriately constrained least-squares adjustment of over-determined and statistically independent observations.

COCHISE COUNTY 2 CORS ARP (PID DH3830), permanent GPS base, NGS control (off site)

Latitude = 31° 23' 27.77105" N	Northing = 27,107.944 ft	<i>Estimated accuracy</i>
Longitude = 109° 55' 44.85303" W	Easting = 184,093.148 ft	Horizontal = Fixed
Ellipsoidal height = 4836.526 ft	Elevation = 4926.866 ft	Vertical = Fixed

Point #1002, 1/2" rebar with aluminum cap, derived coordinates (on site)

Latitude = 31° 23' 14.13617" N	Northing = 25,775.798 ft	<i>Estimated accuracy</i>
Longitude = 110° 00' 13.78081" W	Easting = 160,774.664 ft	Horizontal = ±0.034 ft
Ellipsoidal height = 4482.839 ft	Elevation = 4573.861 ft	Vertical = ±0.046 ft

Point #1006, 1/2" rebar with plastic cap, derived coordinates (on site)

Latitude = 31° 23' 26.45539" N	Northing = 27,020.754 ft	<i>Estimated accuracy</i>
Longitude = 110° 00' 13.25560" W	Easting = 160,823.072 ft	Horizontal = ±0.047 ft
Ellipsoidal height = 4507.190 ft	Elevation = 4598.196 ft	Vertical = ±0.057 ft

Selected References

Primary resource: The National Geodetic Survey (<http://www.ngs.noaa.gov/>)

Some NGS web pages of particular interest

Control station datasheets: <http://www.ngs.noaa.gov/cgi-bin/datasheet.prl>

The Geodetic Tool Kit: <http://www.ngs.noaa.gov/TOOLS/>

Online Positioning User Service (OPUS): <http://www.ngs.noaa.gov/OPUS/>

Continuously Operating Reference Stations (CORS): <http://www.ngs.noaa.gov/CORS/>

The Geoid Page: <http://www.ngs.noaa.gov/GEOID/>

NGS State Geodetic Advisors:

<http://www.ngs.noaa.gov/ADVISORS/AdvisorsIndex.shtml>

Federal Geographic Data Committee (1998) *Geospatial Positioning Accuracy Standards*, FGDC-STD-007.2-1998, Federal Geographic Data Committee, Reston, Virginia, USA, 128 pp., <http://www.fgdc.gov/standards/projects/FGDC-standards-projects/accuracy/>, [includes Standards for Geodetic Networks (Part 2), National Standard for Spatial Data Accuracy (Part 3), and Standards for Architecture, Engineering, Construction (A/E/C) and Facility Management (Part 4)].

Hager, J.W., Behensky, J.F., and Drew, B.W. (1989) The Universal Grids: Universal Transverse Mercator (UTM) and Universal Polar Stereographic (UPS), *DMA Technical Manual 8358.2*, Defense Mapping Agency, Fairfax, Virginia, USA, 49 pp., “TM8358_2.pdf” in http://earth-info.nga.mil/GandG/publications/tm8358.2/TM8358_2.pdf.

Hager, J.W., Fry, L.L., Jacks, S.S. and Hill, D.R. (1990) Datums, Ellipsoids, Grids, and Grid Systems, *DMA Technical Manual 8358.1*, Edition 1, Defense Mapping Agency, Fairfax, Virginia, USA, 150 pp., <http://earth-info.nga.mil/GandG/publications/tm8358.1/toc.html>.

Snyder, J.P. (1987) *Map Projections — A Working Manual*, U.S. Geological Survey Professional Paper 1395, U.S. Government Printing Office, Washington, D.C., USA, 383 pp.

Stem, J.E., (1990) State Plane Coordinate System of 1983, *NOAA Manual NOS NGS 5*, U.S. Department of Commerce, National Oceanic and Atmospheric Administration, National Geodetic Survey, Rockville, Maryland, USA, 119 pp., http://www.ngs.noaa.gov/PUBS_LIB/ManualNOSNGS5.pdf.

Van Sickle, J. (2004) *Basic GIS Coordinates*, CRC Press LLC, Boca Raton, Florida, USA, 173