

Trimble® R7/R8 GPS Receiver

User Guide



Version 1.00
Revision A
September 2003

Corporate Office

Trimble Navigation Limited
Engineering and Construction Division
5475 Kellenburger Road
Dayton, Ohio 45424-1099
U.S.A.

Copyright and Trademarks

© 2001-2003, Trimble Navigation Limited. All rights reserved.

Trimble, the Globe & Triangle logo, and GPS Total Station are trademarks of Trimble Navigation Limited, registered in the United States Patent and Trademark Office. Configuration Toolbox, eRTK, Micro-Centred, SiteNet, Trimble Geomatics Office, Trimble Survey Controller, Trimble Survey Pro, TRIMMARK, TRIMTALK, TSC1, TSCe, and Zephyr are trademarks of Trimble Navigation Limited.

Bluetooth is a trademark owned by Bluetooth SIG, Inc. and licensed to Trimble Navigation Limited

All other trademarks are the property of their respective owners.

Release Notice

This is the September 2003 release (Revision A) of the *Trimble R7/R8 GPS Receiver User Guide*.

The following limited warranties give you specific legal rights. You may have others, which vary from state/jurisdiction to state/jurisdiction.

Hardware Limited Warranty

Trimble warrants that this Trimble hardware product (the "Product") shall be free from defects in materials and workmanship and will substantially conform to Trimble's applicable published specifications for the Product for a period of one (1) year, starting from the date of delivery. The warranty set forth in this paragraph shall not apply to software/firmware products.

Software and Firmware License, Limited Warranty

This Trimble software and/or firmware product (the "Software") is licensed and not sold. Its use is governed by the provisions of the applicable End User License Agreement ("EULA"), if any, included with the Software. In the absence of a separate EULA included with the Software providing different limited warranty terms, exclusions, and limitations, the following terms and conditions shall apply. Trimble warrants that this Trimble Software product will substantially conform to Trimble's applicable published specifications for the Software for a period of ninety (90) days, starting from the date of delivery.

Warranty Remedies

Trimble's sole liability and your exclusive remedy under the warranties set forth above shall be, at Trimble's option, to repair or replace any Product or Software that fails to conform to such warranty ("Nonconforming Product"), or refund the purchase price paid by you for any such Nonconforming Product, upon your return of any Nonconforming Product to Trimble in accordance with Trimble's standard return material authorization procedures.

Warranty Exclusions and Disclaimer

These warranties shall be applied only in the event and to the extent that: (i) the Products and Software are properly and correctly installed, configured, interfaced, maintained, stored, and operated in accordance with Trimble's relevant operator's manual and specifications, and; (ii) the Products and Software are not modified or misused. The preceding warranties shall not apply to, and Trimble shall not be responsible for defects or performance problems resulting from (i) the combination or utilization of the Product or Software with products, information, data, systems or devices not made, supplied or specified by Trimble; (ii) the operation of the Product or Software under any specification other than, or in addition to, Trimble's standard specifications for its products; (iii) the unauthorized modification or use of the Product or Software; (iv) damage caused by accident, lightning or other electrical discharge, fresh or salt water immersion or spray; or (v) normal wear and tear on consumable parts (e.g., batteries).

THE WARRANTIES ABOVE STATE TRIMBLE'S ENTIRE LIABILITY, AND YOUR EXCLUSIVE REMEDIES, RELATING TO PERFORMANCE OF THE PRODUCTS AND SOFTWARE. EXCEPT AS OTHERWISE EXPRESSLY PROVIDED HEREIN, THE PRODUCTS, SOFTWARE, AND ACCOMPANYING DOCUMENTATION AND MATERIALS ARE PROVIDED "AS-IS" AND WITHOUT EXPRESS OR IMPLIED WARRANTY OF ANY KIND BY EITHER TRIMBLE NAVIGATION LIMITED OR ANYONE WHO HAS BEEN INVOLVED IN ITS CREATION, PRODUCTION, INSTALLATION, OR DISTRIBUTION, INCLUDING, BUT NOT LIMITED TO, THE IMPLIED WARRANTIES OF MERCHANTABILITY AND FITNESS FOR A PARTICULAR PURPOSE, TITLE, AND NONINFRINGEMENT. THE STATED EXPRESS WARRANTIES ARE IN LIEU OF ALL OBLIGATIONS OR LIABILITIES ON THE PART OF TRIMBLE ARISING OUT OF, OR IN CONNECTION WITH, ANY PRODUCTS OR SOFTWARE. SOME STATES AND JURISDICTIONS DO NOT ALLOW LIMITATIONS ON DURATION OR THE EXCLUSION OF AN IMPLIED WARRANTY, SO THE ABOVE LIMITATION MAY NOT APPLY TO YOU.

TRIMBLE NAVIGATION LIMITED IS NOT RESPONSIBLE FOR THE OPERATION OR FAILURE OF OPERATION OF GPS SATELLITES OR THE AVAILABILITY OF GPS SATELLITE SIGNALS.

Limitation of Liability

TRIMBLE'S ENTIRE LIABILITY UNDER ANY PROVISION HEREIN SHALL BE LIMITED TO THE GREATER OF THE AMOUNT PAID BY YOU FOR THE PRODUCT OR SOFTWARE LICENSE OR U.S.\$25.00. TO THE MAXIMUM EXTENT PERMITTED BY APPLICABLE LAW, IN NO EVENT SHALL TRIMBLE OR ITS SUPPLIERS BE LIABLE FOR ANY INDIRECT, SPECIAL, INCIDENTAL, OR CONSEQUENTIAL DAMAGES WHATSOEVER UNDER ANY CIRCUMSTANCE OR LEGAL THEORY RELATING IN ANY WAY TO THE PRODUCTS, SOFTWARE, AND ACCOMPANYING DOCUMENTATION AND MATERIALS, (INCLUDING, WITHOUT LIMITATION, DAMAGES FOR LOSS OF BUSINESS PROFITS, BUSINESS INTERRUPTION, LOSS OF BUSINESS INFORMATION, OR ANY OTHER PECUNIARY LOSS), REGARDLESS OF WHETHER TRIMBLE HAS BEEN ADVISED OF THE POSSIBILITY OF ANY SUCH LOSS AND REGARDLESS OF THE COURSE OF DEALING WHICH DEVELOPS OR HAS DEVELOPED BETWEEN YOU AND TRIMBLE. BECAUSE SOME STATES AND JURISDICTIONS DO NOT ALLOW THE EXCLUSION OR LIMITATION OF LIABILITY FOR CONSEQUENTIAL OR INCIDENTAL DAMAGES, THE ABOVE LIMITATION MAY NOT APPLY TO YOU.

Regulations and Safety

The Bluetooth module inside your receiver is a radio-modem transmitter and receiver.

Regulations regarding the use of the radio-modems vary greatly from country to country. In some countries, the unit can be used without obtaining an end-user license. Other countries require end-user licensing. Consult your local communications governing agency for licensing information.

Before operating this receiver, determine if authorization or a license to operate the unit is required in your country. It is the responsibility of the end user to obtain an operator's permit or license for this receiver radio-modem for the location or country of use.

STATEMENT ACCORDING FCC PART 15.19

This device complies with Part 15 of the FCC Rules. Operation is subject to the following two conditions: (1) this device may not cause harmful interference, and (2) this device must accept any interference received, including interference that may cause undesired operation.

STATEMENT ACCORDING FCC PART 15.21

Modifications not expressly approved by Trimble could void the user's authority to operate the equipment.

STATEMENT ACCORDING FCC PART 15.105

This equipment has been tested and found to comply with the limits for a Class B digital device, pursuant to Part 15 of the FCC Rules. These limits are designed to provide reasonable protection against harmful interference in a residential installation. This equipment generates, uses and can radiate radio frequency energy and, if not installed and used in accordance with the instructions, may cause harmful interference to radio communications. However, there is no guarantee that interference will not occur in a particular installation. If this equipment does cause harmful interference to radio or television reception, which can be determined by turning the equipment off and on, the user is encouraged to try to correct the interference by one or more of the following measures:

- Reorient or relocate the receiving antenna.
- Increase the separation between the equipment and receiver.
- Connect the equipment into an outlet on a circuit different from that to which the receiver is connected.
- Consult the dealer or an experienced radio/TV technician for help.

Type Approval

Type approval, or acceptance, covers technical parameters of the equipment related to emissions that can cause interference. Type approval is granted to the manufacturer of the transmission equipment, independent from the operation or licensing of the units. Some countries have unique technical requirements for operation in particular radio-modem frequency bands. To comply with those requirements, Trimble may have modified your equipment to be granted Type approval. Unauthorized modification of the units voids the Type approval, the warranty, and the operational license of the equipment.

Safety

EXPOSURE TO RADIO FREQUENCY RADIATION

The radiated output power of the internal Bluetooth wireless radio is far below the FCC radio frequency exposure limits. Nevertheless, the wireless radio shall be used in such a manner that this receiver is 2.0cm or further from the human body. The internal wireless radio operates within guidelines found in radio frequency safety standards and recommendations, which reflect the consensus of the scientific community. Trimble therefore believes the internal wireless radio is safe for use by consumers. The level of energy emitted is far less than the electromagnetic energy emitted by wireless devices such as mobile phones. However, the use of wireless radios may be restricted in some situations or environments, such as aboard airplanes. If you are unsure of restrictions, you are encouraged to ask for authorization before turning on the wireless radio.

Contents

1	Introduction	13
	Related Information	13
	Technical Assistance	14
	Your Comments.	14
	Trimble R7 GPS Receiver	
2	Overview	17
	Introduction	18
	Features	18
	Use and Care	19
	COCOM Limits.	20
3	Setting up the Receiver	21
	Introduction	22
	Parts of the Receiver	22
	Front panel	23
	Rear panel	24
	Top panel.	25
	Bottom panel	27
	Setup Guidelines	28
	Environmental conditions	28
	Sources of electrical interference	28
	General guidelines	29
	Postprocessed Setup.	30
	Pole-Mounted Setup	32

Backpack Setup	38
Other System Components	40
Radios	40
Cellular modems	43
Antennas	45
CompactFlash cards	46
4 General Operation	47
Introduction	48
Button Functions	48
LED Behavior	49
Logging/Memory LED.	50
SV Tracking LED	50
Radio LED	51
Battery 1 LED and Battery 2 LED.	51
Starting and Stopping the Receiver	51
Logging Data	52
Logging internally	52
Logging to a Trimble controller	53
Resetting to Defaults	53
Formatting a CompactFlash Card.	54
Batteries and Power	54
Battery charging and storage.	57
Operation with the TSC1/TSCe controller.	57
Power output	58
Firmware	59
5 Configuration	61
Introduction	62
Configuring the Receiver in Real Time.	62
Configuring the Receiver Using Application Files	63
Application Files	63
Special application files	64

	Timed application files	66
	Applying application files	68
	Storing application files	68
	Naming application files	68
6	Transferring Data	69
	Introduction	70
	Connecting to the Office Computer.	71
	Transferring Data	73
	Transferring Files Directly from a CompactFlash Card	74
	Deleting Files in the Receiver.	76
	Supported File Types	76
7	Software Utilities.	77
	Introduction	78
	GPS Configurator Software.	78
	Installing GPS Configurator	78
	Configuring the Trimble R7 receiver	79
	Configuration Toolbox Software	80
	Installing Configuration Toolbox	80
	Creating and editing application files	80
	WinFlash Software	83
	Installing WinFlash.	83
	Upgrading firmware	83
	Adding frequencies for the 450 MHz internal radio	85
	Configuring the internal 900 MHz radio setup.	87
8	Specifications	89
	Introduction	90
	Physical Specifications	90
	Positioning Specifications	91
	Technical Specifications	92

9	Default Settings	93
	Introduction	94
	Default Settings	95
	Resetting to Factory Defaults	96
	Examples	97
	Default behavior	97
	Power up settings.	98
	Logging after power loss.	99
	Disabling logging	99
	Application files	100
10	Cables and Connectors	101
	Introduction	102
	Port 1, 2, and 3 Connectors	102
	Power/serial data cable	104
	Event Marker/1PPS Cable	105
	GPS Antennas and Cables	107
11	Event Marker Input and 1PPS Output	109
	Introduction	110
	Event Marker Input	110
	Enabling and configuring event marker input	110
	1PPS Output.	114
	1PPS pulse definition	114
	ASCII time tag definition	115
	Enabling and configuring 1PPS output	116
	Trimble R8 GPS Receiver	
12	Overview	121
	Introduction	122
	Features	122
	Use and Care	124

	COCOM Limits	124
13	Setting up the Receiver	125
	Introduction	126
	Parts of the Receiver	126
	Front panel	126
	Lower housing	127
	Setup Guidelines	129
	Environmental conditions	129
	Sources of electrical interference	129
	General guidelines	130
	Pole-Mounted Setup	130
	Other System Components	131
	Radios	131
	Cellular modems and external radios	132
14	General Operation	135
	Introduction	136
	Button Functions	137
	LED Behavior	137
	LED flash patterns	138
	Starting and Stopping the Receiver	138
	Logging Data	139
	Logging internally	139
	Logging to a Trimble controller	140
	Resetting to Defaults	140
	Batteries and Power	140
	Battery charging and storage	141
	Power output	142
	Firmware	142

15	Configuration	143
	Introduction	144
	Configuring the Receiver in Real Time	144
	Configuring the Receiver Using Application Files	145
	Application Files	145
	Special application files	146
	Applying application files	148
	Storing application files	148
	Naming application files	148
16	Software Utilities	149
	Introduction	150
	GPS Configurator Software	150
	Installing GPS Configurator	150
	Configuring the Trimble R8 receiver	151
	Configuration Toolbox Software	152
	Installing Configuration Toolbox	152
	Creating and editing application files	152
	WinFlash Software	155
	Installing WinFlash	155
	Upgrading firmware	155
	Adding frequencies for the 450 MHz internal radio	157
	Configuring the internal 900 MHz radio setup	159
17	Specifications	161
	Introduction	162
	Physical Specifications	162
	Positioning Specifications	163
	Technical Specifications	164
18	Default Settings	165
	Introduction	166
	Default Settings	167

Resetting to Factory Defaults	168
Default behavior	168
Power up settings.	168
19 Cables and Connectors	169
Introduction	170
Port 1 and 2 Connectors.	170
Power/Serial Data Cables	172
 Trimble R7 and R8 Appendixes	
A NMEA-0183 Output	177
Introduction	178
NMEA-0183 Outputs	178
Common Message Elements	180
Message values.	180
NMEA Messages	181
B RTCM Output.	195
RTCM Output	196
Message Scheduling	197
C Troubleshooting	199
 Index	

Introduction

Welcome to the *Trimble R7/R8 GPS Receiver User Guide*. This manual describes how to install, set up, and use a Trimble® R7 or R8 GPS receiver.

Even if you have used other Global Positioning System (GPS) products before, Trimble recommends that you spend some time reading this manual to learn about the special features of this product.

If you are not familiar with GPS, visit our website for an interactive look at Trimble and GPS at:

- www.trimble.com

Trimble assumes that you are familiar with Microsoft Windows and know how to use a mouse, select options from menus and dialogs, make selections from lists, and refer to online help.

Related Information

An electronic copy of this manual is available in portable document format (PDF) on the *Trimble R7, Trimble R8, 5700, and 5800 GPS Receiver CD*. Use Adobe Reader to view the contents of this file.

Other sources of related information are:

- Release notes – the release notes describe new features of the product, information not included in the manual, and any changes to the manual. They are provided as a PDF on the CD. Use Adobe Reader to view the contents of the release notes.
- Registration – register your receiver to automatically receive e-mail notifications of Trimble R7 receiver firmware upgrades and new functionality. To register, do one of the following:
 - Run the *Trimble R7, Trimble R8, 5700, and 5800 GPS Receiver CD*.
 - Register electronically via the internet by completing the form and submitting.
 - Print the registration form that is on the CD, fill it in, and fax or mail it to the address shown.

Contact your local Trimble Dealer for more information about the support agreement contracts for software and firmware, and an extended warranty program for hardware.

- Trimble training courses – consider a training course to help you use your GPS system to its fullest potential. For more information, visit the Trimble website at www.trimble.com/training.html

Technical Assistance

If you have a problem and cannot find the information you need in the product documentation, *contact your local Distributor*. Alternatively, request technical support using the Trimble website at:

- www.trimble.com/support.html

Your Comments

Your feedback about the supporting documentation helps us to improve it with each revision. E-mail your comments to ReaderFeedback@trimble.com.

SECTION

I

TRIMBLE R7 GPS RECEIVER

Overview

In this chapter:

- Introduction
- Features
- Use and Care
- COCOM Limits

Introduction

This chapter introduces the Trimble R7 GPS receiver. This receiver is designed for GPS surveying applications. The receiver features one-touch logging for ease of use, and five LEDs that let you monitor the survey in progress and the available battery capacity.

The Trimble R7 tracks GPS satellites on both the L1 and L2 frequencies to provide precise position data for land survey applications. The receiver records GPS data on an internal CompactFlash card and makes all data available through serial or USB ports.

You can use the Trimble R7 alone by logging data internally, or as part of the GPS Total Station® system, which logs GPS data from the receiver to a Trimble controller running the Trimble Survey Controller™ or Trimble Survey Pro™ software.

Features

The receiver provides the following features:

- Trimble R-track technology, which allows the receiver to track the L2 Civil signal (L2C)
- Centimeter-accuracy real-time positioning with RTK/OTF data, and up to 10 Hz position updates
- Submeter-accuracy real-time positioning using pseudorange corrections
- Adaptive dual-frequency RTK engine
- WAAS/EGNOS capability (Wide Area Augmentation System/European Geo-Stationary Navigation System)
- Automatic OTF (on-the-fly) initialization while moving
- 1PPS (One Pulse Per Second) output
- Dual event-marker input

- USB port for data transfer
- Type I CompactFlash card for data storage
- Internal charging of batteries (no external battery charger required)
- Three RS-232 serial ports for:
 - NMEA output
 - RTCM SC-104 input and output
 - Trimble Format (CMR) input and output
- Two TNC ports for connecting to the GPS and radio antennas

Use and Care

The Trimble R7 is designed to withstand the rough treatment that typically occurs in the field. However, the receiver is a high-precision electronic instrument and should be treated with reasonable care.



Warning – Operating or storing the receiver outside the specified temperature range can damage it. For more information, see Physical specifications, page 90.

High-power signals from a nearby radio or radar transmitter can overwhelm the receiver circuits. This does not harm the instrument, but it can prevent the receiver electronics from functioning correctly. Avoid using the receiver within 400 meters of powerful radar, television, or other transmitters. Low-power transmitters such as those used in cellphones and two-way radios normally do not interfere with receiver operations.

For more information, contact your local Trimble distributor.

COCOM Limits

The U.S. Department of Commerce requires that all exportable GPS products contain performance limitations so that they cannot be used in a manner that could threaten the security of the United States. The following limitations are implemented on the Trimble R7 receiver.

Immediate access to satellite measurements and navigation results is disabled when the receiver's velocity is computed to be greater than 1000 knots, or its altitude is computed to be above 18,000 meters. The receiver continuously resets until the COCOM situation is cleared.

Setting up the Receiver

In this chapter:

- Introduction
- Parts of the Receiver
- Setup Guidelines
- Postprocessed Setup
- Pole-mounted Setup
- Backpack Setup
- Other System Components

Introduction

This chapter provides general setup information, connection information, and cabling diagrams for the most common uses of the Trimble R7 receiver.

Parts of the Receiver

All operating controls, ports, and connectors on the receiver are located on its four main panels, as shown in Figure 3.1. This section provides a brief overview of the features of each of these panels.

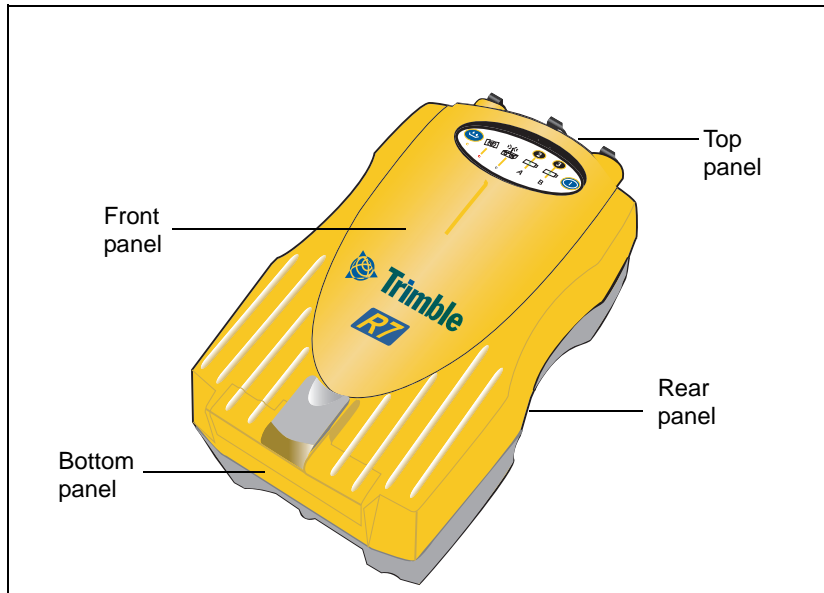

Figure 3.1 Panels on the Trimble R7 receiver

Front panel

Figure 3.2 shows the front panel of the Trimble R7. This panel contains the five indicator LEDs, the two buttons, and the catch for the CompactFlash/USB door.

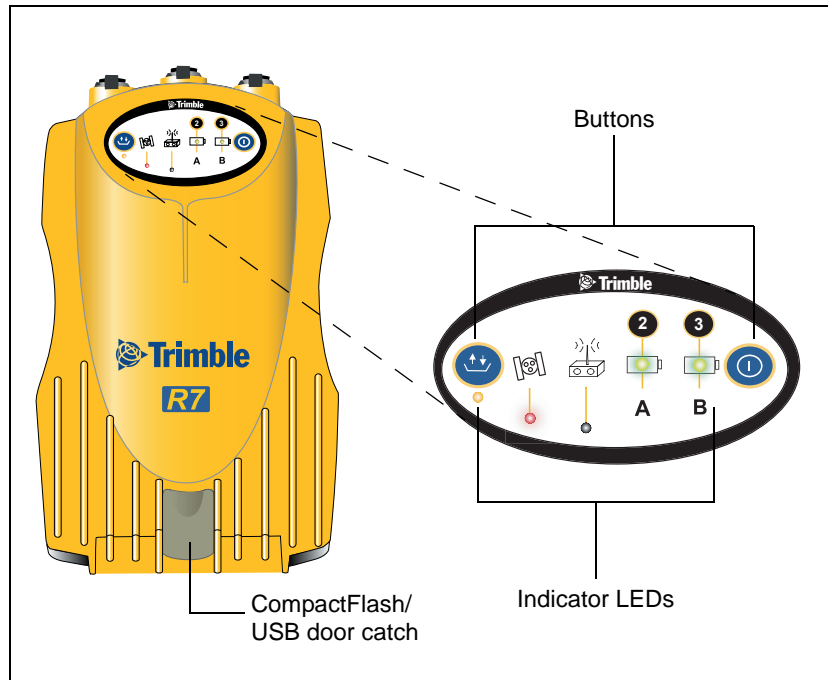

Figure 3.2 Front panel

The two buttons control data logging, data management, power, and settings. For more information, see [Button Functions](#), page 48.

The indicator LEDs show the status of logging, power, satellite tracking, and radio reception. For more information, see [LED Behavior](#), page 49.

Rear panel

Figure 3.3 shows the rear panel of the Trimble R7. This panel contains a slot for attaching the receiver catch lock, and the catches for the two battery compartments on the bottom panel. The catch lock should already be attached to your receiver.

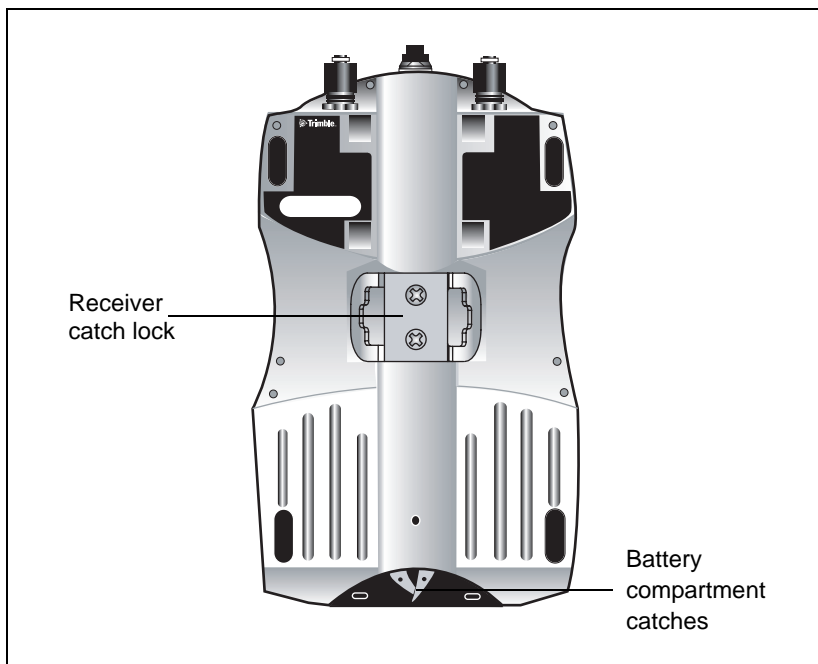

Figure 3.3 Rear panel

To mount the receiver on a pole, you need to attach the receiver bracket to the pole and insert the catch lock into the bracket. For more information, see Pole-Mounted Setup, page 32.

Top panel

Figure 3.4 shows the top panel of the Trimble R7. This panel contains the three power/serial data ports and (TNC) ports for GPS and radio antenna connections.

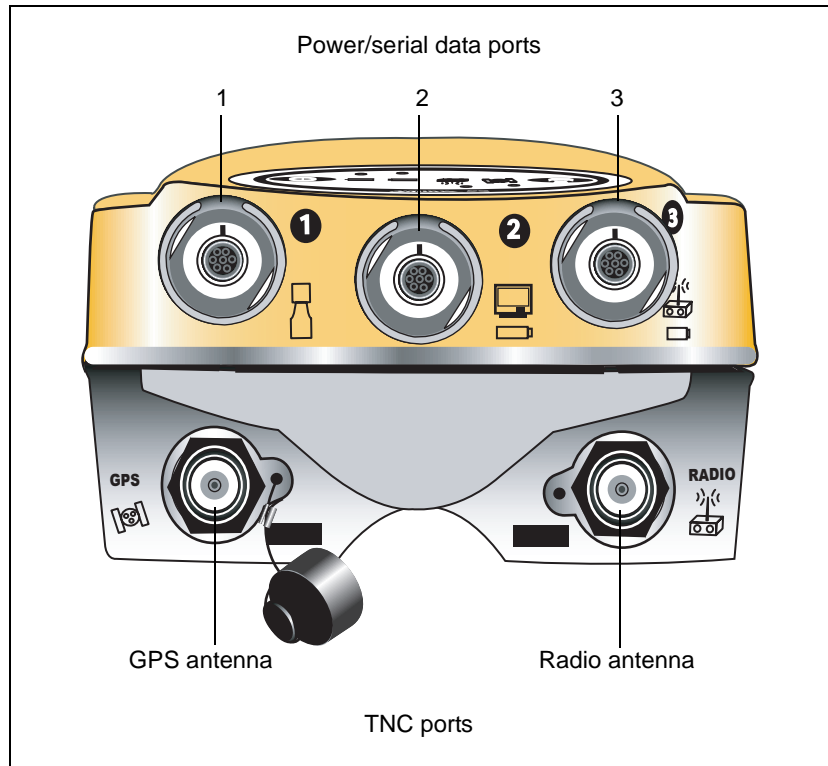







Figure 3.4 Top panel

3 Setting up the Receiver

Each port on the top panel is marked with an icon to indicate its main function.

Table 3.1 Trimble R7 receiver ports

Icon	Name	Connections
	Port 1	Trimble controller, event marker, or computer
	Port 2	Power in, computer, 1PPS, or event marker
	Port 3	External radio, power in
	GPS	GPS antenna
	RADIO	Radio communications antenna

The power/serial data ports are all 7 pin 0-shell Lemo connectors. Both Port 2 and Port 3 can accept external power. For information on default port settings, see *Default Settings*, page 95. For information on connector pinouts, see *Cables and Connectors*, page 101.

The TNC port connectors are color-coded for easy system setup. Connect the yellow GPS antenna cable to the yellow TNC port marked GPS, and connect the blue Range Pole antenna (RPA) cable to the blue TNC connector marked RADIO. For more information on connecting the Trimble R7 system, see the following sections in this chapter.

Bottom panel

Figure 3.5 shows the bottom panel of the Trimble R7. This panel contains the USB port, the CompactFlash port, and the compartments for the two internal batteries.

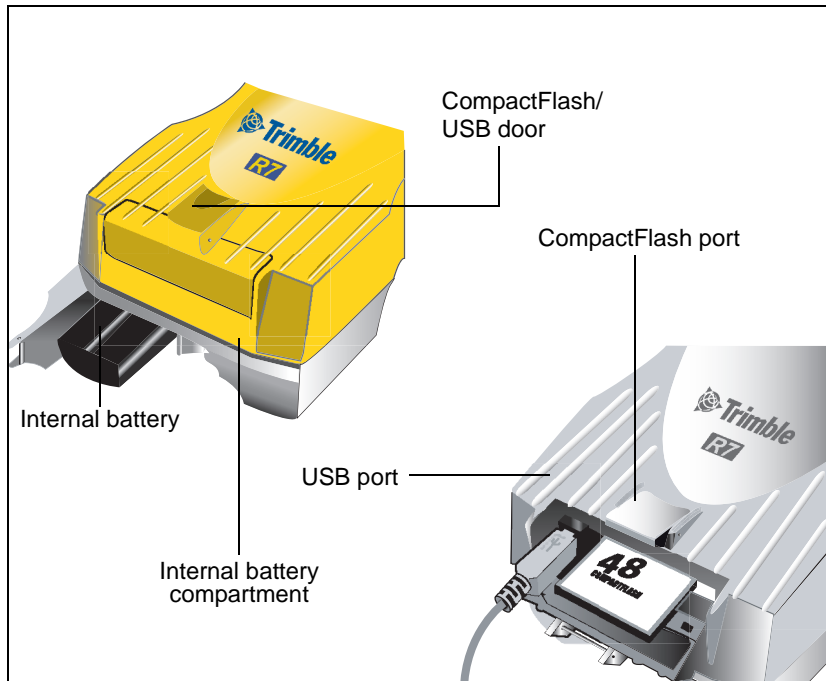

Figure 3.5 Bottom panel

The CompactFlash/USB door conceals the CompactFlash port and USB port. To open the door, push the catch on the front panel down.



Warning – When no USB cable is connected, or when using the receiver in a harsh environment, keep this door closed to keep moisture, dust, and dirt out of the ports. The temperature rating of the receiver applies only when all doors on the receiver are closed.

Setup Guidelines

Consider the following guidelines when setting up the Trimble R7.

Environmental conditions

Although the Trimble R7 has a waterproof housing, reasonable care should be taken to keep the unit dry. Avoid exposure to extreme environmental conditions, including:

- Water
- Heat greater than 65° C (149° F)
- Cold less than -40° C (-40° F)
- Corrosive fluids and gases

Avoiding these conditions improves the receiver performance and long-term reliability.

Sources of electrical interference

Avoid the following sources of electrical and magnetic noise:

- Gasoline engines (spark plugs)
- Televisions and PC monitors
- Alternators and generators
- Electric motors
- Equipment with DC-to-AC converters
- Fluorescent lights
- Switching power supplies

General guidelines

The following guidelines apply whenever you set up your receiver for operation:

- When plugging in a Lemo cable, make sure that the red dots on the receiver port and the cable connector line up. *Never* use force to plug cables in, as this may damage the connector pins.
- When disconnecting a Lemo cable, grasp the cable by the sliding collar or lanyard and pull the cable connector straight out of the port. Do not twist the connector or pull on the cable itself.
- To securely connect a TNC cable, align the cable connector with the receiver receptacle and thread the cable connector onto the receptacle until snug.
- Insert the internal batteries with the battery contacts facing the CompactFlash/USB door. The undersides of the batteries have a center groove for alignment when being inserted into the receiver.

Postprocessed Setup

For a postprocessed survey, you only need:

- the Trimble R7 receiver
- a Zephyr™ or Zephyr Geodetic antenna
- a GPS antenna cable

Other equipment, as described below, is optional.

To set up the Trimble R7 for a postprocessed survey:

1. Set up the tripod with the tribrach and antenna adapter over the survey mark.

Instead of a tripod, you can use a range pole with a bipod. However, Trimble recommends that you use a tripod for greater stability.

2. Mount the antenna on the tribrach adapter.
3. Use the tripod clip to hang the receiver on the tripod.
4. Connect the yellow GPS antenna cable to the Zephyr antenna.
5. Connect the other end of the GPS antenna cable to the yellow TNC port on the receiver.
6. If external power is required, connect a battery with a 0-shell Lemo connection to Port 2 or Port 3 on the receiver.

Figure 3.6 shows the Trimble R7 receiver postprocessed setup.



Figure 3.6 Postprocessed setup

***Note** – Instead of hanging the receiver on the tripod, you can place the receiver in its base case. Run the antenna cable out of the portal in the side of the base case to the antenna so that the case can stay closed while the receiver is running.*

Pole-Mounted Setup

To mount the Trimble R7 on a pole, you need to do the following:

1. Mount the eRTK™ Range Pole antenna (RPA).
2. Mount the receiver.
3. Mount the Trimble controller.

This section provides detailed instructions on each of these three steps.

Mounting the Range Pole antenna (RPA)

To mount the RPA on the pole:

1. Install the RPA bracket 7.5 cm (3") from the pole top by placing the two pieces together and securing with screws. If you are using a 1" diameter pole, place the bracket inserts inside the bracket before securing.

Note – You can use a quarter-wave whip (“rubber duck”) antenna attached directly to the receiver instead of the RPA.

2. Connect the yellow TNC-to-TNC GPS cable and run it through the RPA bracket clips where it is labeled on the bracket. Make sure that the right-angle connector is at the top.

Note – The cable must be routed inside the RPA, through the bracket, or it will affect the RPA radio reception performance.

3. Align the TNC connector on the RPA with the GPS antenna cable on the bracket, and while feeding the cable through the RPA, slide the RPA onto the bracket until it clicks.

Figure 2.7 shows the Trimble R7 receiver pole-mounted setup.

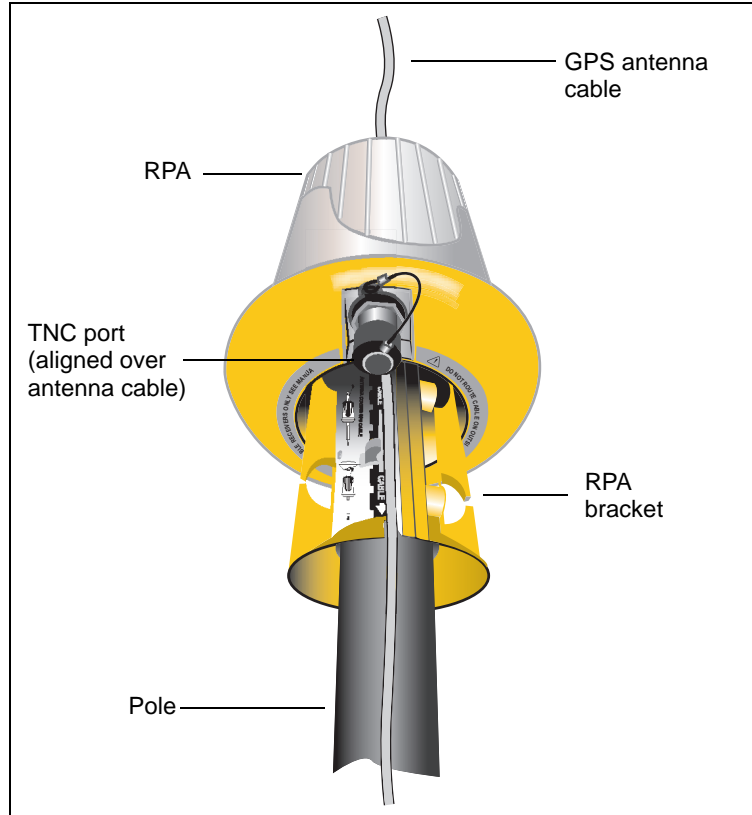

Figure 3.7 RPA and bracket

4. Mount the Zephyr antenna on the range pole.
5. Connect the GPS antenna cable. Make sure that the GPS cable is not hanging over the top of the RPA.
6. Connect the blue TNC-to-TNC radio cable to the RPA.

Mounting the Trimble R7 receiver

To mount the receiver on the pole:

1. Attach the receiver bracket to the pole:
 - a. Place the bracket against the pole, approximately 0.5 m from the ground.

Note – If you are using a 1" diameter pole, flip the black insert around inside the bracket, as shown in Figure 3.8.

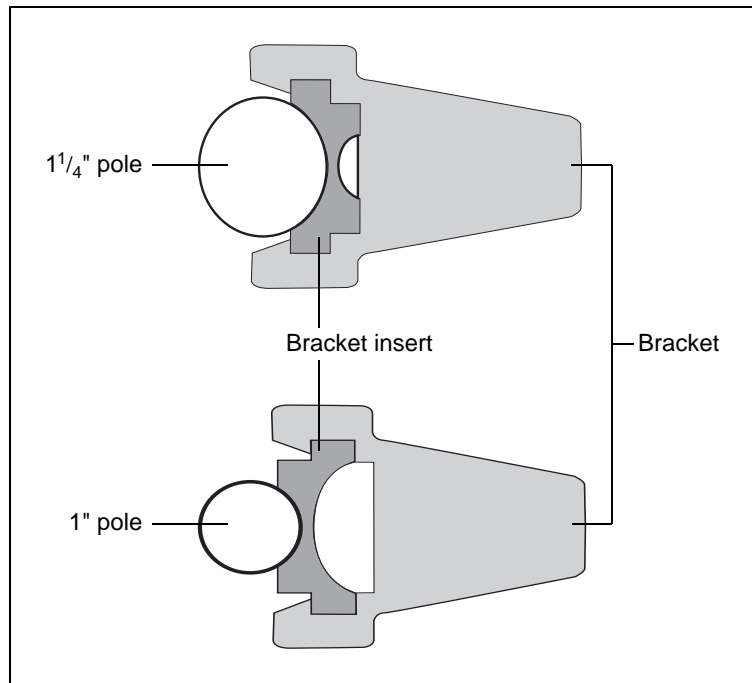

Figure 3.8 Receiver bracket insert

- b. Close the gates of the bracket around the pole.
 - c. Seat the base of the clip lock in the opposite gate.
 - d. Lock the clip lock.

If the clip lock is too tight to be locked, turn it one or two turns counterclockwise and try again. If it is too loose, turn it one or two turns clockwise and try to lock it again.

2. Mount the receiver on the bracket:
 - a. Pull the bracket side locks in towards the pole.
 - b. Set the receiver catch lock in the bracket.
 - c. Holding the receiver in the bracket, pull the side locks back to their original positions, as shown in Figure 3.9.

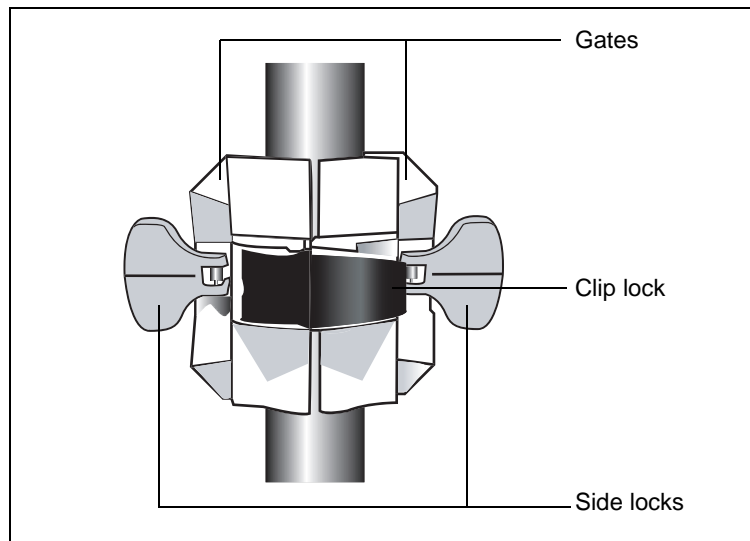

Figure 3.9 Trimble R7 receiver bracket

3. Connect the blue TNC radio communications cable to the blue TNC port on the receiver. If necessary, adjust the position of the receiver to remove cable slack.
4. Connect the yellow TNC GPS antenna cable to the yellow TNC port on the receiver. If necessary, adjust the position of the receiver to remove cable slack.

Mounting the TSC1/TSCe controller

To mount the TSC1™/TSCe™ controller on the pole:

1. Mount the controller bracket on the pole:
 - a. Place the bracket against the pole at a comfortable height.
 - b. Rotate the clamping screw on the bracket pole until tight.
 - c. Place the controller into the cradle assembly and tighten the clamping mechanism.
 - d. Any cables running down the pole should be run through the machined groove on the inside of the controller bracket.
 - e. Position the controller in the preferred position for operation by pressing the spring-loaded release button on the cradle, pulling the assembly outward, and rotating the cradle assembly to the desired angle. Reseat the cradle in the proper position by lining up the alignment pins and pushing inward until the release button locks.
2. Connect one end of the 2 ft 0-shell to 0-shell Lemo cable to the TSC1/TSCe controller.
3. Connect the other end of the Lemo cable to Port 1 on the receiver.
4. Place the hand grip below the controller bracket (or above it, depending on the position of the bracket), with the cables running through the grip.
5. Secure any loose cables, using the velcro cable ties.

Figure 2.10 shows the pole-mounted setup.

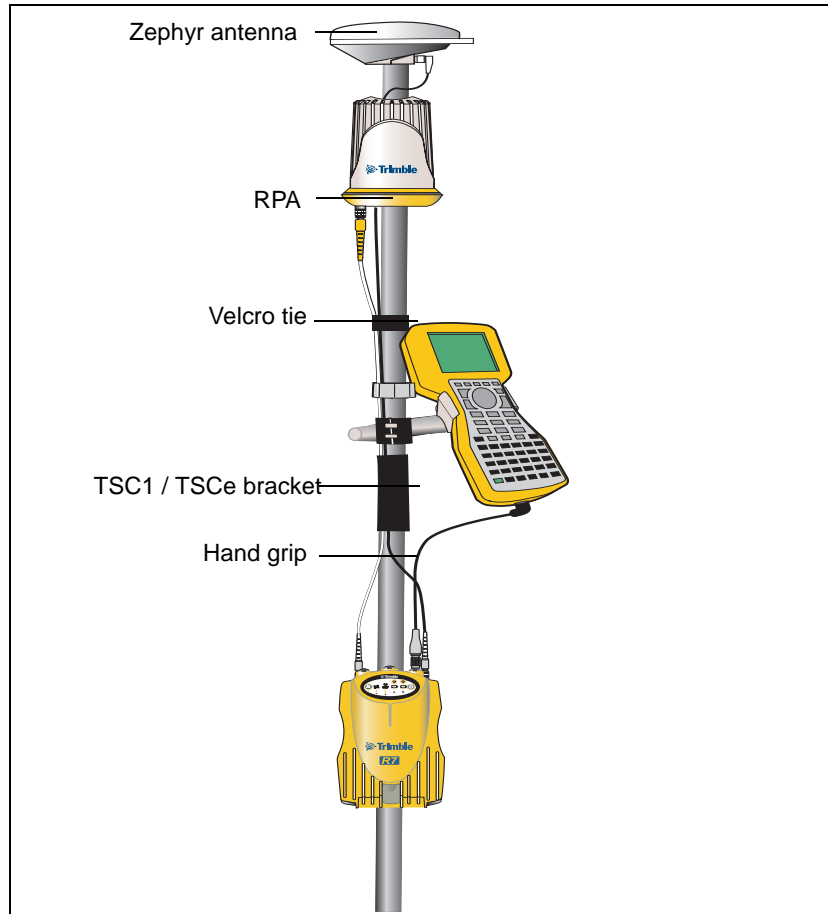

Figure 3.10 Pole-mounted setup

Backpack Setup

Both the whip and RPA antennae are suitable for use in a backpack. The RPA is installed in the same manner as for the pole-mounted setup (see Pole-Mounted Setup, page 32).



Warning – The RPA is tuned for operation with the GPS antenna cable running through it. Operating it from a backpack may reduce its operating range. Trimble recommends using the whip antenna.

To set up the Trimble R7 for use in a backpack:

1. Insert the receiver into the backpack with the ports on the top panel facing upwards and the front panel facing outwards. Secure the receiver around the middle with the velcro strap.
2. Attach the Zephyr™ antenna to a range pole.
3. Attach the whip antenna mount to one of the fittings on the top of the backpack.
4. The backpack has a feedthrough on both sides at the top and on both sides near the bottom to allow cables to be positioned out of the way of the main zipper. Run the radio communications cable through at the top, and connect it to the blue TNC port on the receiver.
5. Connect the straight end of the yellow GPS cable to the yellow TNC port on the receiver.
6. Run the right-angle connector on the yellow GPS cable through the top or side slot on the backpack, and connect it to the Zephyr antenna.
7. Connect one end of the 6 ft 0-shell to 0-shell cable to Port 1 on the receiver.
8. Run the 0-shell cable through the side slot of the backpack and connect it to the TSC1/TSCe controller.

Figure 3.11 shows the backpack setup.

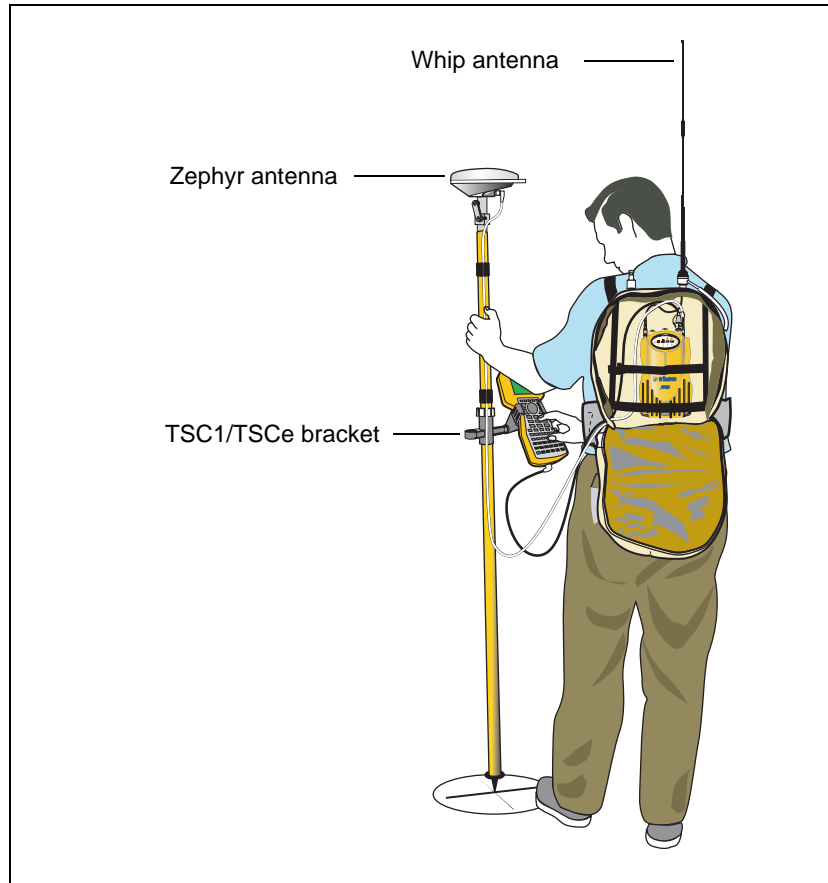

Figure 3.11 Backpack setup

Other System Components

This section describes optional components that you can use with the Trimble R7 receiver.

Radios

Radios are the most common data link for Real-Time Kinematic (RTK) surveying. The Trimble R7 receiver is available with an optional internal radio in either the 450 or 900 MHz UHF bands. You can also connect an external radio to Port 3, whether the internal radio is installed or not.

The Trimble R7 supports the following Trimble base radios when using the internal receiver radio:

- TRIMMARK™ 3
- TRIMMARK IIe
- TRIMTALK™ 450S
- SiteNet™ 450
- SiteNet 900

Internal Radio Setup

You can configure the Trimble R7 optional internal radio using any of the following:

- the GPS Configurator software
- the WinFlash software
- the Trimble Survey Controller software

For more information, refer to the GPS Configurator Help, the WinFlash Help, or the *Trimble Survey Controller User Guide*.

By default, the internal UHF radio has only a few frequencies installed. Use WinFlash to configure additional frequencies. For more information, see Adding frequencies for the 450 MHz internal radio, page 85.

External Radio Setup

To use an external radio with the Trimble R7 receiver, you need an external power source for the radio.

To set up a Trimble R7 using an external radio:

1. Connect one end of the yellow GPS antenna cable to the yellow TNC port on the receiver.
2. Connect the other end of the GPS antenna cable to a Zephyr or Zephyr Geodetic antenna.
3. Connect the external radio to Port 3 on the receiver.
4. Connect a radio antenna to the external radio.

3 Setting up the Receiver

Figure 3.12 shows a TRIMMARK 3 connected to a Trimble R7 receiver.

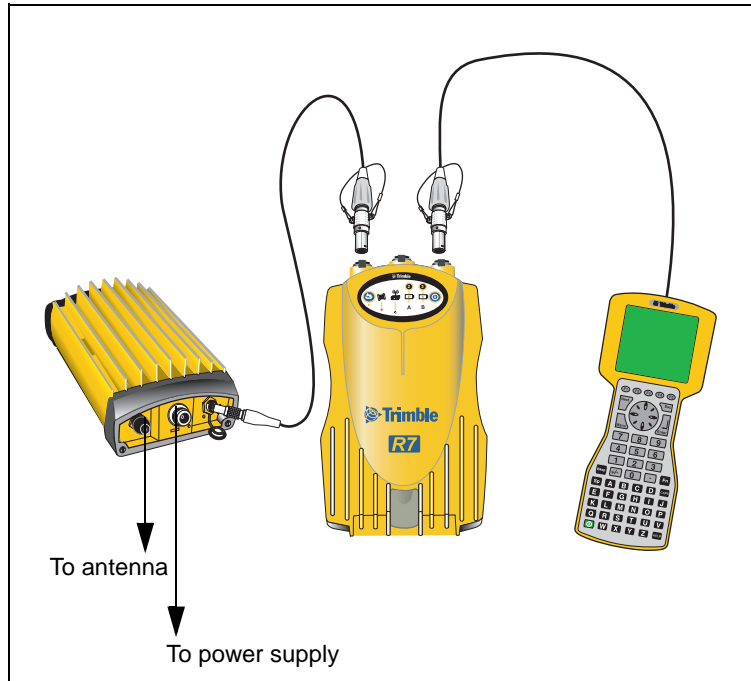

Figure 3.12 Connecting an external radio

5. Connect an external power source to Port 2 on the receiver.

***Note** – External rover radios must have their own power source because the internal Lithium-Ion batteries do not supply enough voltage. Alternatively, supply external power to port 2 of the receiver, and enable power out on port 3. Base radios must have their own power source because of their high power consumption.*

Alternatively, you can apply external power directly to the radio, if it supports it.

You can use a 10 Ah battery, a 6 Ah battery, or camcorder batteries. The choice of power supply depends on the application, and whether you are using the radio as a reference or rover radio. For more information about the power capabilities of the Trimble R7, see *Batteries and Power*, page 54.

6. Configure the external radio using Trimble Survey Controller. Alternatively, you can configure a TRIMMARK 3 radio using WinFlash or the configuration software supplied with the radio.

For more information, refer to the *Trimble Survey Controller User Guide* or the appropriate Help.

7. Set up any other equipment as required, depending on whether you are using the radio as a reference or a rover radio.

Cellular modems

You can use a cellular modem instead of a radio as your data communications link. Cellular modems and other radio links can be used to extend the limits of your surveys.

To connect a cellular modem to a Trimble R7 receiver, you need the following:

- A Trimble R7 receiver
- A custom-designed cellular modem, or a cellphone that can transmit and receive data
- Serial (cellphone to DB9) cable (supplied with the cellular modem or phone)
- Trimble DB9 to 0-shell Lemo cable

Note – This cable is suitable only if flow control can be disabled on the cellular modem. If the cellular modem does not support this functionality, a special cable is required. For more

3 Setting up the Receiver

*information, refer to the document *Using Cellular and CDPD Modems for RTK*, which is available from your local Trimble Distributor.*

Figure 3.13 shows the components required to connect a cellphone to a Trimble R7 receiver.

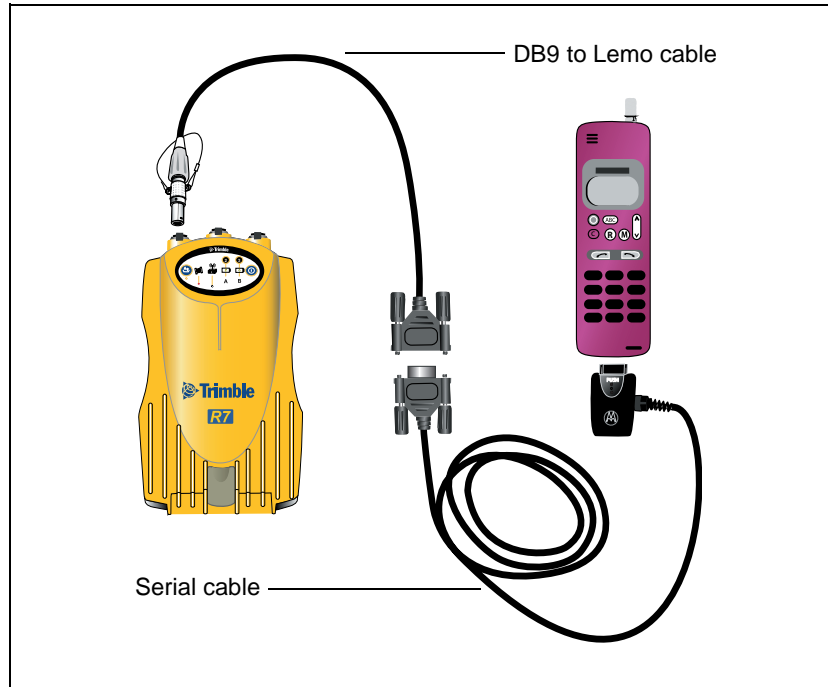

Figure 3.13 Connecting a cellphone

For more information on using a cellular modem as a data link, refer to the *Trimble Survey Controller User Guide*.

Antennas

The Trimble R7 receiver should normally be used with a Zephyr or Zephyr Geodetic antenna. These antennas have been designed specifically for use with the Trimble R7.

Use Figure 3.14 as a guide for measuring the height of the Zephyr and Zephyr Geodetic antennas. The Zephyr antenna is designed to be measured to the top of the notch. The Zephyr Geodetic (shown) has been designed to be measured to the bottom of the notch.

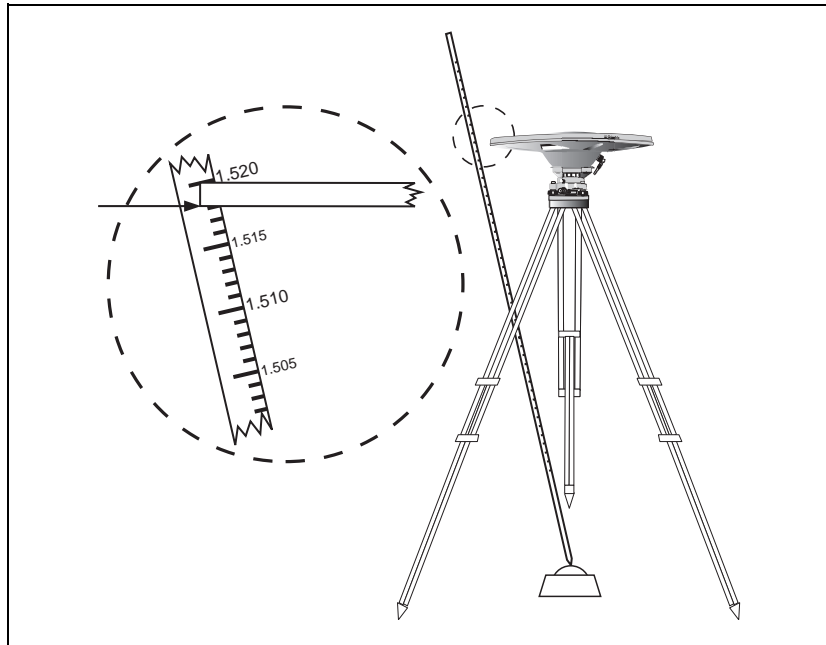

Figure 3.14 Measuring antenna height

Older models of antennas, such as the Choke Ring or Micro-Centered™ L1/L2 antennas, need more power to operate than the Zephyr models. To configure the receiver to output more power on the antenna port, select the correct antenna type in GPS Configurator, or through the Trimble controller. For information on how to do this, contact your local Trimble Service Provider.

CompactFlash cards

The Trimble R7 logs data internally on a CompactFlash card. However, it only support the Type I CompactFlash card. Trimble recommends that you use an industrial-rated CompactFlash card, as commercial cards have a limited operating temperature range.

Before logging data to a CompactFlash card, format the card to ensure the integrity of the file system. To format the card, insert it in the receiver and then hold down **[P]** for 30 seconds.

***Note** – Make sure that you format your CompactFlash card in the receiver. This prevents data on the card from being corrupted if the card is removed while data is being logged. Formatting the card in your PC may cause data corruption, or loss of data.*

When inserting the card, make sure that it slides into the card slot properly.



Warnings:

- The Trimble R7 allows for a maximum of 512 files on the CompactFlash card, regardless of the card's capacity. The file names must be in 8.3 format, otherwise files copied to the CompactFlash card may cause data corruption or loss of data when logging.
 - If the card does not seat into the pins correctly, do **not** use force or you may damage the pins. Remove the card and reinsert it carefully.
-

General Operation

In this chapter:

- Introduction
- Button Functions
- LED Behavior
- Starting and Stopping the Receiver
- Logging Data
- Resetting to Defaults
- Formatting a CompactFlash Card
- Batteries and Power

Introduction

All the controls that you need for general operation of the Trimble R7 receiver are located on the front panel, as shown in Figure 4.1.

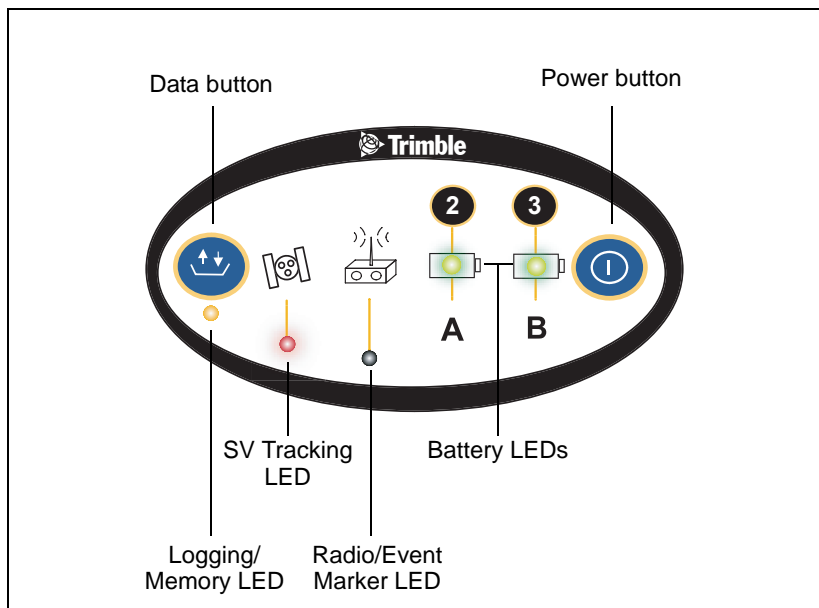

Figure 4.1 Controls on the front panel of the Trimble R7

For more information about other panels of the Trimble R7, see *Parts of the Receiver*, page 22.

Button Functions

The Trimble R7 has only two buttons: a Power button, represented in this manual by **(P)**, and a Data button, represented by **(D)**.

Use **(P)** to switch the receiver on or off, and to perform data management functions such as deleting files or resetting the receiver.

Use **(D)** to start or stop logging. This button is only effective when the receiver is switched on and has completed any power-up and initialization tasks.

Table 4.1 describes the main functions of the two buttons.

Table 4.1 Button functions

Action	Power button	Data button
Turn the receiver on	Press	
Turn the receiver off	Hold for 2 seconds	
Start logging data internally		Press
Stop logging data internally		Hold for 2 seconds
Delete the ephemeris file	Hold for 15 seconds	
Reset the receiver to factory defaults	Hold for 15 seconds	
Delete application files	Hold for 30 seconds	
Format the CompactFlash card	Hold for 30 seconds	

Note – The term “press” indicates that you should press the button and release it immediately. The term “hold” indicates that you should press the button and hold it down until the time indicated has elapsed.

LED Behavior

The five LEDs on the top panel of the receiver indicate various operating conditions. Generally, a lit or slowly flashing LED indicates normal operation, an LED that is flashing quickly indicates a condition that may require attention, and an unlit LED indicates that no operation is occurring. The following table defines each possible LED state.

The term ...	means that the LED ...
Flash	is lit briefly every 3 seconds
Slow flash	alternates slowly between being lit and unlit

4 General Operation

The term ...	means that the LED ...
Fast flash	alternates rapidly between being lit and unlit
On	is lit
Off	is unlit

Logging/Memory LED

The yellow Logging/Memory LED below the  button indicates the status of data logging and memory usage.

Behavior	Meaning
On	Data is being logged.
Slow flash	Enough FastStatic data has been logged. Alternatively, if the red SV Tracking LED is on solid at the same time, the receiver is in Monitor mode, and is checking for new firmware to install.
Fast flash	Data is being logged but memory is low.
Flash	The receiver is in Sleep mode, and will wake up five minutes before the scheduled start time of a timed application file.
Off	Data is not being logged, or the CompactFlash card is full.

SV Tracking LED

The red SV Tracking LED below the SV icon  indicates the status of satellite tracking.

Behavior	Meaning
Slow flash	Tracking four or more satellites.
Fast flash	Tracking three or fewer satellites.
Off	Not tracking any satellites.
On	The receiver is in Monitor mode, and is checking for new firmware to install.

Radio LED

The green Radio LED below the Radio icon  indicates the status of data input and output.

Behavior	Meaning
Slow flash	A data packet or event marker has been received.

Battery 1 LED and Battery 2 LED

The Battery LEDs inside the two Battery icons  indicate the status of the two internal batteries, or the power sources connected on Ports 2 and 3.

By default, each battery LED indicates the status of the external power source on the corresponding port. If no external source is detected, each LED indicates the status of an internal battery. The color of the LED indicates whether the power source is currently in use (green) or is on standby (yellow).

Color	Meaning	Behavior	Meaning
Green	Power source is in use	On	Healthy
		Fast flash	Low power
		Off	No power source is present
Yellow	Power source is on standby	On	Healthy
		Fast flash	Low power
		Flash	Dead
		Off	No power source is present

Starting and Stopping the Receiver

To turn on the receiver, press **[P]**.

To turn off the receiver, hold down **[P]** for two seconds.

Logging Data

You can log data to the CompactFlash card in the receiver, or to the survey device.

Logging internally

The Trimble R7 receiver logs GPS data internally on a CompactFlash card. You can then use the Trimble Data Transfer utility to transfer logged data files to your office computer. The transferred files are in Trimble DAT (.dat) format.



Warning – The Trimble R7 allows for a maximum of 512 files on the CompactFlash card, regardless of the card's capacity. The file names must be in 8.3 format, otherwise files copied to the CompactFlash card may cause data corruption or loss of data when logging.

Data is logged using the current logging settings configured in the receiver. Data files logged internally are named automatically.

To begin internal logging, press **[D]**. The Logging/Memory LED lights up.

To stop logging, hold down **[D]** for at least two seconds. The Logging/Memory LED turns off.

Note – When the CompactFlash card is full, the receiver stops logging data, and the Logging/Memory LED switches off. Existing data files are not overwritten.

Approximate storage requirements for different logging rates are shown in Table 4.2. The values shown are for a one-hour logging session with six satellites visible.

Table 4.2 Storage requirements

Logging rate	Memory required
10 Hz	2,588 KB
1 Hz	335 KB

Table 4.2 Storage requirements (continued)

Logging rate	Memory required
5 seconds	87 KB
15 seconds	37 KB

Note – If power is lost, or the CompactFlash card is removed while logging, the file system is designed so that a maximum of ten seconds of data will be lost, regardless of the logging rate. To ensure that this behavior occurs, use GPS Configurator to perform a quick format of the CompactFlash card before logging data to the card for the first time.

Logging to a Trimble controller

When the Trimble R7 receiver is connected to a Trimble controller, you can log GPS data from the receiver to the controller, or to a PC card inserted in the controller. When you use a Trimble controller, you do not use the receiver's controls. Instead, you use the controller functions to set logging options, specify filenames, and control when logging occurs.

Data is stored in job files, which can be transferred to your office computer using Trimble's Data Transfer utility.

For more information on logging data from a receiver using a Trimble controller refer, to the user guide for your particular controller.

Resetting to Defaults

To reset the receiver to its factory default settings, hold down **[P]** for at least 15 seconds.



Warning – Make sure that you do not hold down **[P]** for more than 30 seconds. After 30 seconds, any application files stored in the receiver are deleted and the CompactFlash card is reformatted.

Resetting the receiver to its factory defaults also deletes any ephemeris file in the receiver.

For more information, see Chapter 9, Default Settings.

Formatting a CompactFlash Card

To format a CompactFlash card for use in a Trimble R7 receiver, insert the card in the CompactFlash port, then hold down **[P]** for at least 30 seconds. After 15 seconds, the receiver is reset to its factory defaults, and any ephemeris file is deleted. After 30 seconds, any files stored on the card are deleted and the CompactFlash card is reformatted.



Warning – Formatting a CompactFlash card while it is in the receiver deletes all the data files on the card and all the application files in the receiver.

***Note** – When you use **[P]** to format the CompactFlash card, a quick format is performed. A quick format reformats the card for use with the Trimble R7 receiver and deletes all data on the card. A full format checks the card for errors or bad sectors, and is only necessary if the card is corrupted. To perform a full format, use GPS Configurator. For more information, see GPS Configurator Software, page 78.*

Batteries and Power

The Trimble R7 can be powered either by its two internal batteries or by an external power source connected to Port 2 or Port 3. The charge provided by the internal batteries depends on the type of survey and operating conditions. Typically, one battery provides about 3.5 hours of power during an RTK survey using the internal radio, and about 5 hours during a survey without the internal radio.

The external power source is always used in preference to the internal batteries. When there is no external power source connected, or if the external power supply fails, the internal batteries are used. The internal batteries are drained in turn, and the receiver automatically switches to the full battery when the first battery is drained.

If no external power is supplied and both internal batteries are drained, none of the data that you have logged is lost. When internal or external power is restored, the receiver restarts in the same state as when power was lost. For example, if the receiver was logging data, the data file is not corrupted, and when power is restored the receiver resumes logging with the same settings as before.

The power supply that is supplied with the Trimble R7 receiver charges the receiver internal batteries while they are still in the receiver. To do this, connect the power supply to the power/serial data cable, connect the cable to Port 2 on the receiver, and connect the power supply to an AC power source, as shown in Figure 4.2.

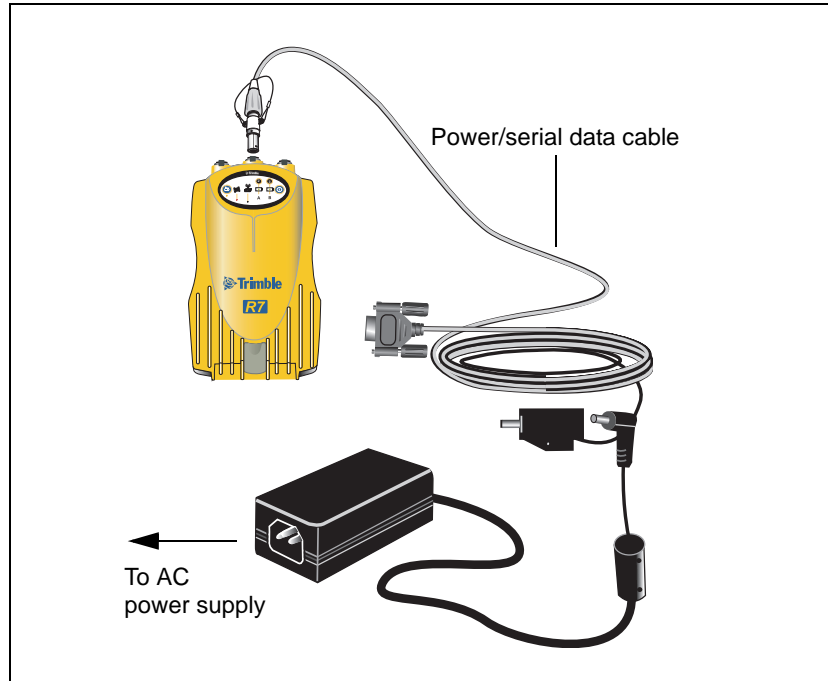

Figure 4.2 Charging the batteries

The two internal batteries take approximately eight hours to charge. They are charged individually, so each battery takes approximately 4 hours to charge. The internal batteries start charging whenever an external power supply of greater than 15 V is detected.

Each receiver in your system is supplied with two internal lithium-ion battery packs. To charge both sets of batteries, connect both receivers to power supplies as shown in Figure 3.2.

Battery charging and storage

Note – All battery types discharge over time when they are not being used. Batteries also discharge faster in colder temperatures. If a lithium-ion battery is to be stored for long periods of time, make sure it is fully charged before storing and re-charged at least every three months.

To protect the battery from deep discharge (5 volts or less), the Trimble R7 system is designed to switch batteries or cease drawing power when the battery pack discharges to 5.9 volts.

A battery that has reached the deep discharge level cannot be recharged and must be replaced. The following recommendations provide optimal performance and extend the life of your batteries:

- Fully charge all new batteries prior to use.
- Do not allow the batteries to discharge below 5 volts.
- Keep all batteries on continuous charge when not in use. Batteries may be kept on charge indefinitely without damage to the receiver or batteries.
- Do not store batteries in the receiver or external charger unless power is applied.
- If you must store the batteries, fully charge them before storing and then recharge them at least every three months.

Operation with the TSC1/TSCe controller

If the receiver is being powered by its internal batteries, it does not supply power to the TSC1/TSCe controller when they are connected. However, the TSC1/TSCe batteries and the Trimble R7 batteries can be charged at the same time from the same power supply. To charge both sets of batteries, use two standard power/serial data cables to connect the TSC1/TSCe controller and the receiver to a power supply, as shown in Figure 4.3.

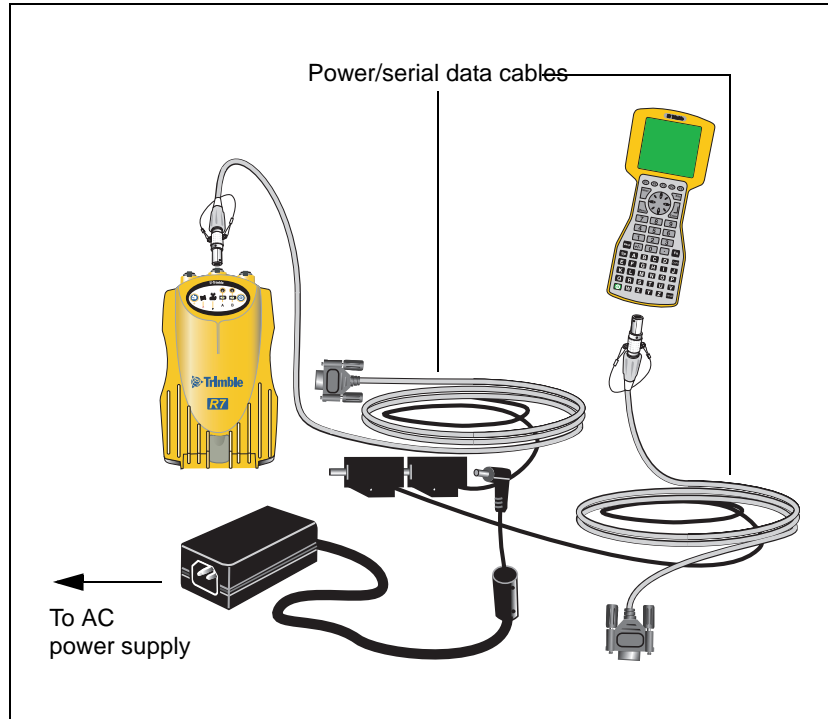

Figure 4.3 Charging receiver and TSC1/TSCe batteries

Power output

If the receiver is being supplied with power from an external source, power is automatically output on Port 1. The output voltage is approximately 0.5 V less than the input voltage. Port 1 outputs a maximum voltage of 20 V, even if the input voltage is higher.

You can use GPS Configurator or Trimble Survey Controller to enable power output on Port 3. Port 3 can be enabled for power output regardless of whether power is supplied internally or externally.

On Port 3, the output voltage is approximately 0.5 V less than the input voltage. For example, if power is being supplied from the internal Lithium ion batteries, the maximum battery voltage is 8.4 V, so the maximum output voltage is 7.9 V.

Note – When you start a survey using Trimble Survey Controller, and you are using an external radio, the software automatically enables power output on Port 3.

Firmware

A receiver's *firmware* is the program inside the receiver that makes the receiver run and controls the hardware. When you need to upgrade the firmware for your Trimble R7 receiver, Trimble recommends that you use WinFlash. For more information, see WinFlash Software, page 83.



Warning – Upgrading the firmware deletes all application files on the Trimble R7 receiver.

An alternative method of upgrading your firmware is to copy the .elf file directly to the CompactFlash card from your computer.

To do this:

1. Connect the CompactFlash card to your desktop computer.
2. Using Windows Explorer, copy the .elf file from your computer to the CompactFlash card.
3. Disconnect the CompactFlash card from your computer and insert it into the receiver.
4. Turn the receiver off.
5. Hold down **[D]** and press **[P]**.

The receiver starts up in Monitor mode, automatically detects the newer version of the firmware, and installs it. In Monitor mode, the red SV Tracking LED is lit solidly and the yellow Logging/Memory LED flashes slowly.

The upgrade takes about two minutes. Once the upgrade procedure is complete, the receiver restarts automatically.

4 General Operation

Configuration

In this chapter:

- Introduction
- Configuring the Receiver in Real Time
- Configuring the Receiver Using Application Files
- Application Files

Introduction

The Trimble R7 receiver has no controls for changing settings. To configure the receiver, use external software, such as the GPS Configurator, Configuration Toolbox™, or Trimble Survey Controller software.

There are two ways to configure the Trimble R7:

- Configuring the receiver in real time
- Applying the settings in an application file

This chapter provides a brief overview of each of these methods, and describes the contents and use of application files.

Configuring the Receiver in Real Time

The GPS Configurator, Configuration Toolbox, and Trimble Survey Controller software all support real-time configuration of the Trimble R7 receiver.

When you configure the receiver in real time, you use one of these software applications to specify which settings you want to change. When you apply the changes, the receiver settings change immediately.

Any changes that you apply to the receiver are reflected in the Current application file, which is always present in the receiver. The Current application file always records the most recent configuration, so if you apply further changes (either in real time or using an application file) the Current file is updated and there is no record of the changes that you applied originally.

For more information on configuring the receiver in real time, see Chapter 7, Software Utilities.

Configuring the Receiver Using Application Files

An application file contains information for configuring a receiver. To configure a receiver using an application file, you need to create the application file, transfer it to the receiver, and then apply the file's settings. Use the Configuration Toolbox software to perform all these tasks.

For more information on applying application files, see Chapter 7, Software Utilities.

Application Files

An application file is organized into records. Each record stores configuration information for a particular area of receiver operation. Application files can include the following records:

- File Storage
- General Controls
- Serial Port Baud/Format
- Reference Position
- Logging Rate
- SV Enable/Disable
- Output Message
- Antenna
- Device Control
- Static/Kinematic
- Input Message
- Timed Activation

An application file does not have to contain all of these records. When you apply an application file, any option that is not included in the records in the file remains at its current setting. For example, if you

apply an application file that only specifies the elevation mask to use, all other settings remain as they were before the application file was applied.

You can store up to twenty different application files in battery-backed memory on the receiver. You can apply an application file's settings at the time it is transferred to the receiver, or at any time afterwards.

Special application files

The Trimble R7 has three special application files, which control important aspects of the receiver's configuration.

Default application file

The default application file (Default.cfg) contains the original receiver configuration, and cannot be changed. This file configures the receiver after it is reset. You can reset the receiver by holding down **[P]** for at least 15 seconds, or by using the reset option in GPS Configurator.

For more information on the default receiver settings, see Default Settings, page 95.

Although you cannot change or delete the default application file, you can use a power up application file to override any or all of the default settings.

Current application file

The current application file (Current.cfg) reflects the current receiver configuration. Whenever you change the receiver's configuration, either in real time or by applying an application file, the current file changes to match the new configuration.

You cannot delete the current file or change it directly, but every change to the receiver's current configuration is applied to the current file as well.

When you switch off the receiver then turn it on again, all the settings from the current application file are applied, so you do not lose any changes that you have made. The only exceptions are the following logging parameters:

- Logging rate
- Position rate
- Elevation mask

These parameters are always reset to the factory default values whenever the receiver is switched off.

Power Up application file

The power up application file (Power_up.cfg) is optional. If a power up file is present, its settings are applied whenever the receiver is powered up.

In this file, you can specify that the receiver is reset to defaults before the power up settings are applied. This ensures that restarting the receiver always results in the same configuration. This method is useful for defining “default” settings for the receiver that differ from those in the default file, which cannot be changed.

Alternatively, you can specify that the power up settings are applied immediately after the current application file’s settings have been applied. Restarting the receiver results in a configuration that uses your default settings for the options you define in the power up file, but the current settings for all other options.

By default, there is no power up application file on the receiver. If you want to use a power up application file, you need to create an application file in Configuration Toolbox and make sure that the *As auto power up file* option is selected in the *File* page. When you transfer this file to the receiver, it is transferred with the name Power_up.cfg, and becomes the new power up file.

The power up file is the only special application file that you can overwrite or delete from the receiver.

Timed application files

A timed application file contains a Timed Activation record which specifies when this file is to be applied. The main use of a timed application file is to automatically start or stop logging at a predefined time.

The Timed Activation record specifies:

- the UTC date and time when the application file is to be applied for the first time
- the interval at which the file is to be reapplied

If you do not specify a repeat interval, the settings are applied only once, at the specified time. If the file specifies a repeat interval, the file's settings are reapplied at the specified interval until the file is deactivated.

Note – If the receiver is logging continuously, the current logging takes precedence over any timed application file stored in the receiver.

Defining timed application files

To send timed application files to a Trimble R7, set up scheduled survey sessions in GPS Configurator. You can define multiple sessions, each specifying:

- basic logging parameters (data logging rate, position logging rate, and elevation mask)
- a starting time
- a duration

When you apply the current settings in GPS Configurator, each defined survey session is sent to the Trimble R7 as a pair of timed application files: the first includes the logging settings and start time, and the second contains settings that stop logging at the end time (which is calculated automatically from the duration you specify).

For more information on scheduled survey sessions, refer to the GPS Configurator Help.

The Trimble R7 can store up to 20 application files, so you can define a maximum of 10 scheduled survey sessions (10 pairs of start/stop timed application files).

Note – You cannot use Configuration Toolbox to define timed application files.

Sleep mode

Whenever you press **(P)** to turn off the Trimble R7, it checks for a timed application file that is due to be activated in the future. If one exists, the receiver goes into Sleep mode instead of powering down.

In Sleep mode, the yellow Logging/Memory LED flashes every three seconds. The receiver wakes up five minutes before the scheduled activation time, so that it is ready to begin logging at the scheduled time.

Applying application files

An application file's settings do not affect the receiver's configuration until you **apply** the application file. You can do this at the same time that you save the file. Alternatively, save the file on the computer or in the receiver, then open it later and apply its settings.

Note – If the application file is a timed file, its settings do not take effect as soon as you apply the file, but at the time that the file specifies for its activation.

Storing application files

You can store application files that you create in Configuration Toolbox on both your receiver and computer. Each file can, for example, represent a different user sharing the same receiver, or a particular mode of operation or survey style. Saving application files on your computer as well as in your receiver is optional, but it is useful because:

- it gives you a permanent copy of the settings you have sent to a receiver, for audit or your own reference
- you can use the same file to configure multiple receivers identically
- you can use an existing application file as a template for creating other application files with similar settings

Naming application files

The filename that you use to store the application file in the computer and the name under which the file is stored in the receiver are always the same. This makes recognizing and keeping track of your application files easier. If you change the name of the file on the receiver, this changes the filename used to store the application file on your computer. Similarly, if you change the filename on the computer, the name of the file in the receiver will change.

Transferring Data

In this chapter:

- Introduction
- Connecting to the Office Computer
- Transferring Data
- Transferring Files Directly from a Compactflash Card
- Deleting Files in the Receiver
- Supported File Types

Introduction

The Trimble R7 receiver keeps satellite measurements and other data in files stored on a CompactFlash card. These files cannot be processed until you transfer them to your office computer.

Note – The receiver supports a maximum of 512 files on the CompactFlash cards.

On returning to the office after completing a survey, transfer the field data to a computer that has the Trimble Geomatics Office™ software installed. You can then process the survey data in Trimble Geomatics Office to produce baselines and coordinates.

Connecting to the Office Computer

The Trimble R7 has three serial (COM) ports and one USB port for connection to the office computer. A USB connection is up to ten times faster than normal serial communications.

Use the standard power/serial data cable to connect the receiver to the computer, as shown in Figure 6.1.

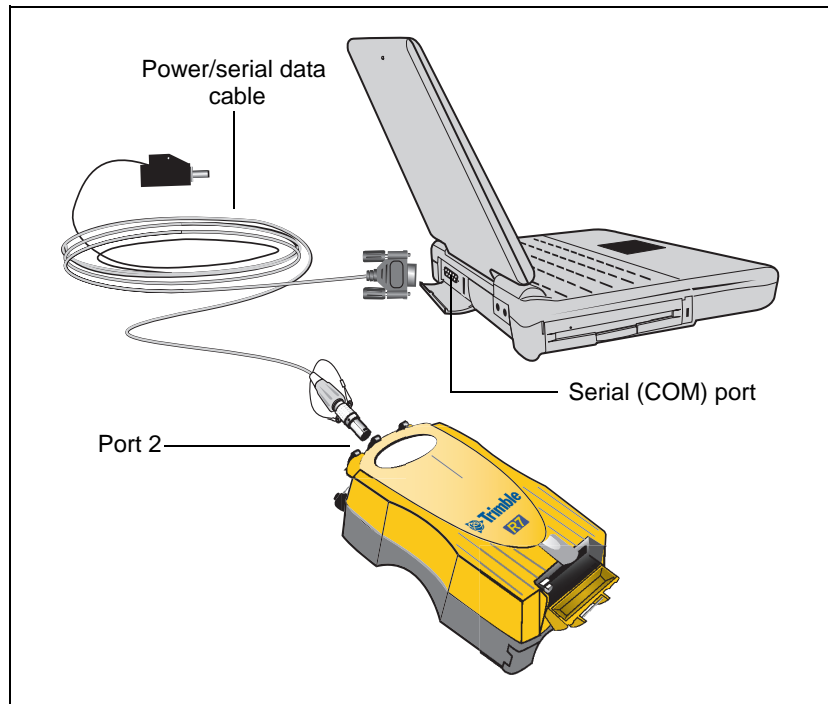

Figure 6.1 Connecting the Trimble R7 to a computer for serial data transfer

6 Transferring Data

Use the USB cable to connect the receiver to the computer, as shown in Figure 6.2.

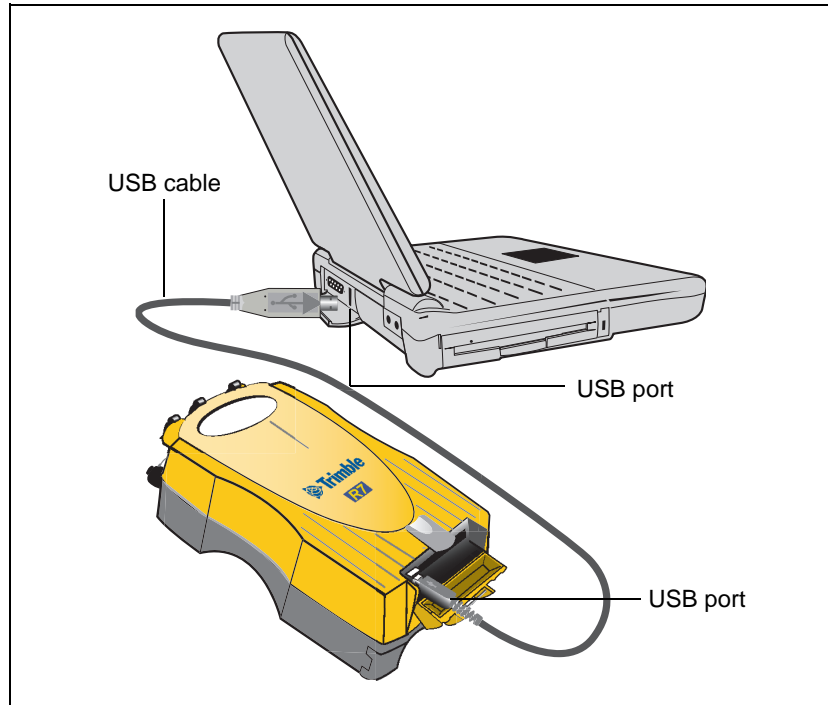

Figure 6.2 Connecting the Trimble R7 to a computer for USB data transfer

Note – When the receiver is connected to a USB port on a computer, it is treated as a peripheral device of the computer. If the receiver is unplugged or powered down, a warning message is displayed on the computer.

Transferring Data

Transfer the data files to the computer using the Trimble Data Transfer utility. You can run this utility as a standalone program or from within Trimble Geomatics Office. For more information about the transfer process, refer to the Data Transfer Help.

Note – When you connect to a receiver in the Data Transfer utility, you must use a GPS Receiver (R/5000 Series) device definition. If you use a GPS Receiver (4000 Series) device definition, the Data Transfer utility will be unable to establish communication with the receiver.

When transfer is complete, the Data Transfer utility automatically converts the file to the DAT format. If you are using Data Transfer from within Trimble Geomatics Office, the *Check-in* dialog appears. For more information, refer to the *Trimble Geomatics Office User Guide*.

Note – A file in DAT format is approximately six times the size of the corresponding file in the Trimble R7 internal format. Before transferring files, make sure that there is enough space on your computer.

Transferring Files Directly from a CompactFlash Card

All data is stored in a Trimble R7 receiver on an internal CompactFlash card. There are two ways to transfer files between the receiver and the office computer:

- Connect the receiver to the office computer and use the Data Transfer utility to transfer files.
- Remove the CompactFlash card from the receiver and connect it directly to your office computer, where it functions like a normal disk drive. Use Windows Explorer to transfer files.

When you use the Data Transfer utility to transfer data files from the CompactFlash card while it is still inserted in the receiver, the Data Transfer utility converts the raw receiver data (.T01) files you select into the Trimble DAT file format.

However, if you connect the CompactFlash card to your computer and then copy or move files to your computer, it treats the card like any other disk drive, and transfers the files without converting them. You need to convert these raw receiver files to DAT format files before you can use them on your office computer.

You can convert receiver data files by using a Windows Explorer extension which is installed on your computer when you install the Data Transfer utility.

***Note** – Although this extension is only available if you have the Data Transfer utility installed, you do not have to run the Data Transfer utility to use it.*

To convert a .T01 file on your office computer into the DAT format:

1. On your office computer, open Windows Explorer and navigate to the location of the .T01 file.
2. Right-click the file, and from the menu that appears select *Convert to DAT format*:

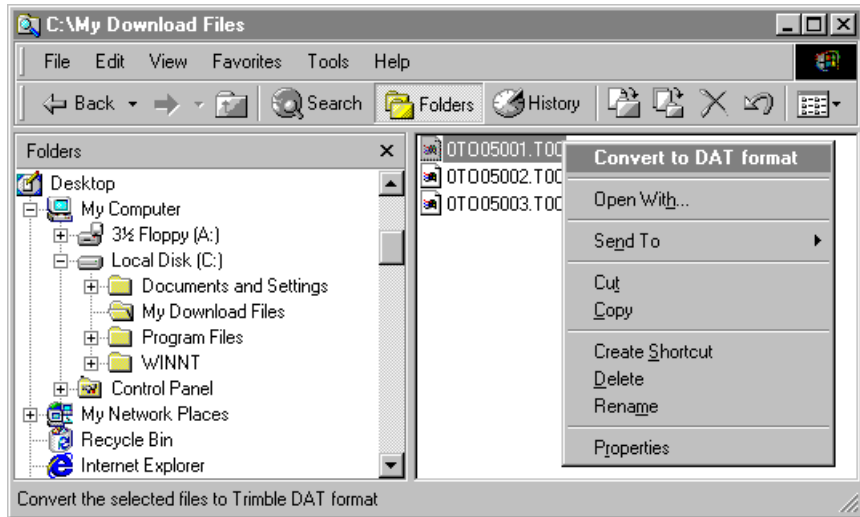

The *DAT File Conversion* dialog appears while the file is converted. When the dialog disappears, the file conversion is complete.

A new file with the same filename but a .dat extension appears in the same folder as the .T01 file.

Deleting Files in the Receiver

You can delete files stored in the receiver at any time. Do one of the following:

- Use the Data Transfer utility in Trimble Geomatics Office.
- Use the TSC1/TSCe controller.
- Hold down the power button (P) for 30 seconds after the receiver has been powered on. (When you use this method, *all* data is deleted, and the CompactFlash card is reformatted.)
- Use GPS Configurator.

Supported File Types

Table 6.1 shows the file types that you can transfer to or from a Trimble R7 receiver, and the software or utility that you must use to transfer each file type.

Table 6.1 Supported file types

File Type	Extensions	Transfer from Trimble R7?	Transfer to Trimble R7?	Software
Ephemeris	.eph	Yes	No	Data Transfer
Raw observations	.T01, .dat	Yes	No	Data Transfer
Receiver firmware files	.elf	No	Yes	WinFlash
Application files	.cfg	Yes	Yes	Configuration Toolbox

Note – The Trimble R7 receiver supports a maximum of 512 files on the CompactFlash card. Files stored on the compact flash must be 8.3 format. The Trimble R7 receiver does not support extended file names.

Software Utilities

In this chapter:

- Introduction
- GPS Configurator Software
- Configuration Toolbox Software
- WinFlash Software

Introduction

This chapter provides information on the software utilities that you can use with the Trimble R7 receiver.

GPS Configurator Software

GPS Configurator is office software that configures selected Trimble GPS receivers.

GPS Configurator lets you:

- check current receiver settings and operation
- change receiver settings in real time

Installing GPS Configurator

A copy of GPS Configurator is included on the *Trimble R7, Trimble R8, 5700, and 5800 GPS Receivers CD*.

To install the software:

1. Insert the CD into the CD drive on your computer.
2. Using Windows Explorer, navigate to the CD drive.
3. Double-click *Setup.exe*.
4. Follow the onscreen instructions.

Configuring the Trimble R7 receiver

To configure a Trimble R7 using GPS Configurator:

1. Connect Port 1, 2, or 3 on the receiver to a serial (COM) port on the computer and apply power.
2. To start GPS Configurator, click  **Start**, then select *Programs / Trimble / GPS Configurator / GPS Configurator*.

The software automatically establishes a connection with the receiver.

3. Make appropriate selections for your required receiver settings.
For more information, refer to the GPS Configurator Help.
4. Click **Apply**.

The settings in GPS Configurator are applied to the receiver.

Configuration Toolbox Software

The Configuration Toolbox software is office software that provides a graphical user interface to help you configure selected Trimble GPS receivers.

Configuration Toolbox lets you:

- create and edit application files
- transfer application files to and from the receiver
- manage application files stored in the receiver

For more information, see Application Files, page 63.

Installing Configuration Toolbox

A copy of Configuration Toolbox is included on the *Trimble R7, Trimble R8, 5700, and 5800 GPS Receivers CD*.

To install the software:

1. Insert the CD into the CD drive on your computer.
2. Using Windows Explorer, navigate to the CD drive.
3. Double-click *Setup.exe*.
4. Follow the onscreen instructions.

Creating and editing application files

You can create an application file and transfer it to the receiver in several different ways. The general workflow includes the following steps:

1. Create and save the application file in Configuration Toolbox.
2. Connect the receiver to the computer and apply power.
3. Open the desired application file in Configuration Toolbox.
4. Transfer this application file to the receiver.

5. Check that the receiver is using the transferred application file.

To create and save an application file to the receiver:

1. To start Configuration Toolbox, click , then select *Programs / Trimble / Configuration Toolbox / Configuration Toolbox*.
2. Select *File / New / Trimble R7*.
3. Specify the receiver settings (for specific information, refer to the Configuration Toolbox documentation).
4. Use *File / Save As* to save the application file:

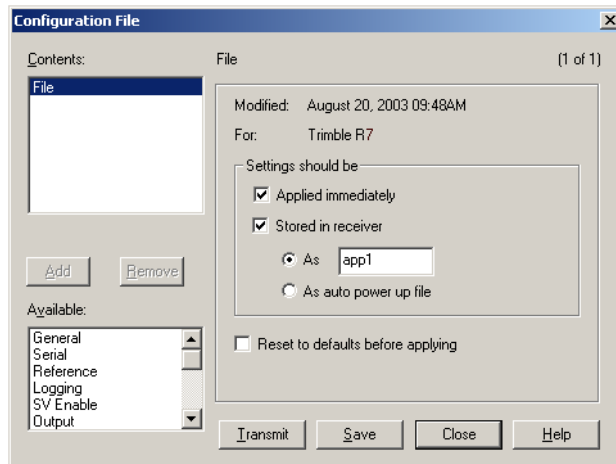

To transfer the application file to the receiver:

1. Connect the power/serial data cable to Port 1 on the Trimble R7.
2. Connect the female DB9 connector on the other end of the power/serial data cable to a serial (COM) port on the computer.
3. Select *File / Open* to open the desired application file.
4. With the file open and the *Configuration File* dialog open, select *Communications / Transmit File*.

A message appears informing you that the application file has been successfully transferred. If an error occurs, select *Communications / Transmit File* again. This overrides any incompatibility in baud rates and enables successful communication.

5. To check whether the transfer was successful, close the *Configuration File* dialog and select *Communications / Get File*.

A list of all application files in the receiver appears. If you selected **Apply Immediately** in the application file, the Current application file will contain the settings in the new file.

6. To apply a different file, select the file you require from the list and then select *Communications / Activate File*.

WinFlash Software

WinFlash communicates with Trimble products to perform various functions including:

- installing software, firmware, and option upgrades
- running diagnostics (for example, retrieving configuration information)
- configuring radios

For more information, online help is also available when using WinFlash.

Note – WinFlash runs on Microsoft Windows 95, 98, NT, 2000, Me, or XP operating systems.

Installing WinFlash

WinFlash can be installed from the *Trimble R7, Trimble R8, 5700, and 5800 GPS Receivers CD*, or from the Trimble website.

Installing WinFlash from the CD

1. Insert the disk into the CD drive on your computer.
2. Using Windows Explorer, navigate to the CD drive.
3. Double-click *Setup.exe*.
4. Follow the onscreen instructions.

Upgrading firmware

Your Trimble R7 receiver is supplied with the latest version of receiver firmware installed. If a later version becomes available, upgrade the firmware installed on your receiver.

WinFlash guides you through the firmware upgrade process. The steps required are described below. For more information, refer to the WinFlash Help.

To upgrade the Trimble R7 receiver firmware:

1. Start WinFlash.

The *Device Configuration* screen appears.

2. From the *Device type* list select Trimble R7 Receiver.
3. From the *PC serial port* field select the serial (COM) port on the computer that the receiver is connected to.
4. Click **Next**.

The *Operation Selection* screen appears. The *Operations* list shows all of the supported operations for the selected device. A description of the selected operation is shown in the *Description* field.

5. Select *GPS software upgrade* and click **Next**.

The *GPS Software Selection* window appears. This screen prompts you to select the software that you want to install on the Trimble R7 receiver.

6. Select the latest version from the *Available Software* list and click **Next**.

The *Settings Review* window appears. This screen prompts you to connect the receiver, suggests a connection method, and then lists the receiver configuration and selected operation.

7. If all is correct, click **Finish**.

Based on the selections shown above, the *Software Upgrade* window appears and shows the status of the operation (for example, Establishing communication with the Trimble R7. Please wait.).

8. Click **OK**.

The *Software Upgrade* window appears again and states that the operation was completed successfully.

9. Click **Menu** to select another operation, or click **Exit** to quit WinFlash.

10. If you click **Exit**, another screen appears asking you to confirm that you want to quit WinFlash. Click **OK**.

Adding frequencies for the 450 MHz internal radio

If your receiver has the optional internal radio installed, you can use WinFlash to add frequencies to the default list.

To add radio frequencies:

1. Start WinFlash.
The *Device Configuration* screen appears.
2. From the *Device type* list select Trimble R7 Receiver.
3. From the *PC serial port* field select the serial (COM) port on the computer that the receiver is connected to.
4. Click **Next**.

The *Operation Selection* screen appears. The *Operations* list shows all of the supported operations for the selected device. A description of the selected operation is shown in the *Description* field.

5. Select **Configure Radio** and click **Next**.

The *Frequency Selection* window appears:

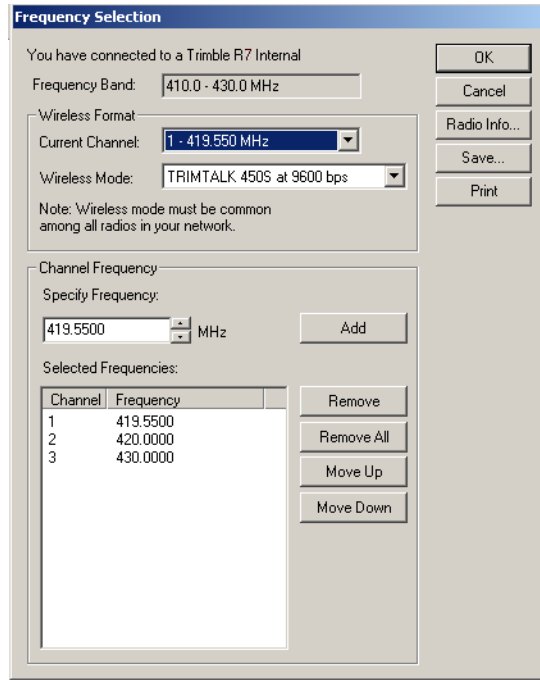

6. In the *Wireless Format* group, select the appropriate channel and wireless mode. The *Wireless Mode* must be the same for all radios in your network.
7. In the *Specify Frequency* field, enter the frequency you require.
8. Click **Add**. The new frequency appears in the *Selected Frequencies* list.

Note – The frequencies that you program must conform to the channel spacing and minimum tuning requirements for the radio. To view this information, click **Radio Info**. You may select either 12.5 or 25 kHz channel spacing. All radios in your network must use the same channel spacing.

9. When you have configured all the frequencies you require, click **OK**.

WinFlash updates the receiver radio frequencies and then restarts the receiver.

Configuring the internal 900 MHz radio setup

To configure the internal 900 MHz radio, use one of the following:

- Trimble Survey Controller running on a Trimble controller
- WinFlash (provided on the *Trimble R7, Trimble R8, 5700, and 5800 GPS Receivers CD*)

The internal radio has 40 selectable networks. You must choose the same network that is configured in the base radio you want to receive from.

Trimble Survey Controller

To configure the radio network using Trimble Survey Controller:

1. Connect the data/power cable to the controller and the receiver and turn on the controller. The receiver starts automatically.
2. From the main menu on the controller, select *Configuration*.
3. In the dialog that appears, select *Survey styles*, then from the *Type* field, select *RTK*.
4. Select *Rover radio*, then from the *Type* field select *Trimble Internal*.
5. Tap the **Connect** softkey.
6. Once connected, in the *Network number* field enter the number of the network set on your base radio.

Note – *The Base Radio Mode field is not used here.*

7. Tap the **Enter** softkey to complete configuration.

WinFlash

To configure the radio network using WinFlash:

1. Connect the data/power cable to Port 1 on the receiver.
2. Connect the female DE-9 connector on the other end of the data/power cable to a serial (COM) port on the computer.
3. Start WinFlash. The *Device Configuration* dialog appears.
4. From the *Device type* list, select *Trimble R7 Receiver*.
5. From the *PC serial port* field, select the serial port on the computer that the receiver is connected to and click **Next**.
6. From the *Operation selection* dialog, select *Configure radio* and click **Next**.
7. Confirm that your current settings are correct and click **Finish**. The *Configure 900MHz radio* dialog appears.
8. In the *Network number* field, select the same network that is set on your base radio.
9. In the *Country setting* field, select one of the following (according to how your base radio was shipped):
 - Your country (if available). This sets the radio to the a specific frequency range being transmitted by the base radio.
 - A single frequency. This limits the frequencies used to those authorized in your particular country.
10. Click **OK**.

WinFlash updates the radio settings and then restarts the receiver.

Specifications

In this chapter:

- Introduction
- Physical Specifications
- Positioning Specifications
- Technical Specifications

Introduction

This chapter lists the specifications of the Trimble R7 receiver.

Physical Specifications

Table 8.1 lists physical specifications for the Trimble R7. The temperature rating of the receiver applies only when all doors on the receiver are closed.

Table 8.1 Physical specifications

Feature	Specification
Size	13.5 cm W x 8.5 cm H x 24 cm L (5.3 in. W x 3.4 in. H x 9.5 in. L)
Weight (with 2 batteries inserted)	1.4 kg (3.0 lb)
Battery life (at 20 °C)	RTK with internal radio: 3.5 hours No internal radio: 5 hours
Power input	11–28 V DC
Operating temperature	–40 °C to +65 °C (–40 °F to +149 °F) ^a
Storage temperature	–40 °C to +80 °C (–40 °F to +176 °F)
Humidity	100% condensing, unit fully sealed
Casing	Dust-proof, shock- and vibration-resistant

^aThe USB port only operates when the temperature is above 0 °C (32 °F). The internal batteries only charge when the temperature is in the range 0 °C to 40 °C (32 °F to 104 °F)

Positioning Specifications

Table 8.2 lists positioning specifications for the Trimble R7.

Table 8.2 Positioning specifications

Positioning	Mode	Horizontal Accuracy (RMS)	Vertical Accuracy (RMS)
RTK (OTF)	Synchronized	1 cm + 1 ppm (× baseline length)	2 cm + 1 ppm (× baseline length)
	Low Latency	2 cm + 2 ppm (× baseline length) ^a	3 cm + 2 ppm (× baseline length) ^a
L1 C/A Code Phase	Synchronized/ Low Latency	.25 m + 1 ppm RMS	.50 m + 1 ppm RMS
Static/ FastStatic	N/A	5 mm + 0.5 ppm (× baseline length)	5 mm + 1 ppm (× baseline length)
WAAS	N/A	Less than 5 m ^b	Less than 5 m ^b

^aDepends on radio link latency.

^b3D RMS values depend on WAAS system performance.

Technical Specifications

Table 8.3 lists technical specifications for the Trimble R7.

Table 8.3 Technical specifications

Feature	Specification
Tracking	24 Channels L1 C/A Code, L2C, L1/L2 Full Cycle Carrier, WAAS/EGNOS support Fully operational during P-code encryption WAAS satellite tracking
Signal processing	Maxwell V architecture Very low-noise C/A code processing Multipath suppression
Start-up	Cold start: < 60 seconds from power on Warm start: < 30 seconds with recent ephemeris
Initialization	Automatic while moving or static
Minimum initialization time	10 sec + 0.5 × baseline length (km)
Communications	Three RS-232 serial ports (Port 1, Port 2, and Port 3) Baud rates up to 115,200 bps RTS/CTS flow control negotiation supported on Port 3 only One USB port (download only)
Configuration	Via user-definable application files or GPS Configurator
Output formats	NMEA-0183: AVR; GGA; GST; GSV; PTNL,GGK; PTNL,GGK_SYNC; HDT; PTNL,PJK; PTNL,PJT; ROT PTNL,VGK; VHD; VTG; ZDA GSOF (Trimble Binary Streamed Output) 1PPS RT17

Default Settings

In this chapter:

- Introduction
- Default Settings
- Resetting to Factory Defaults
- Examples

Introduction

All Trimble R7 receiver settings are stored in application files. The Default application file, `Default.cfg`, is stored permanently in the receiver, and contains the factory default settings for the Trimble R7. Whenever the receiver is reset to its factory defaults, the current settings (stored in the Current application file, `Current.cfg`) are reset to the values in the Default application file.

You cannot modify the Default application file. However, if there is a Power Up application file (`Power_Up.cfg`) in the receiver, the settings in this file can be applied immediately after the Default application file, overriding the factory defaults.

For more information about application files, see [Application Files](#), page 63.

Default Settings

Table 9.1 shows the default settings for the Trimble R7 receiver, as defined in the default application file.

Table 9.1 Default settings

Function		Factory Default
SV Enable		All SVs enabled
General Controls:	Elevation mask	13°
	SNR mask	7
	RTK positioning mode	Low Latency
	Motion	Kinematic
Power Output 3		Disabled
1PPS time tags		Off
ASCII time tags		Off
Serial Port 1:	Baud rate	38400
	Format	8-None-1
	Flow control	None
Serial Port 2:	Baud rate	38400
	Format	8-None-1
Serial Port 3:	Baud rate	38400
	Format	8-None-1
	Flow control	None
Input Setup:	Station	Any
NMEA/ASCII (all messages)		All Ports Off
Streamed output		All Types Off Offset = 00
RT17/Binary		All Ports Off
CMR output		[Static] CMR: cref ID 0000
RTCM output		RTCM: Type 1 ID 0000

Table 9.1 Default settings (continued)

Function		Factory Default
Reference position:	Latitude	0°
	Longitude	0°
	Altitude	0.00 m HAE
Antenna:	Type	Unknown external
	Height (true vertical)	0.00 m
	Group	All
	Measurement method	Bottom of antenna mount
Logging rate		15 sec
Position rate		5 min
Measurement rate		10 Hz

Resetting to Factory Defaults

To reset the receiver to its factory defaults, as defined above, do one of the following:

- Press and hold down **[P]** on the receiver for 15 seconds.
- In Configuration Toolbox, select *Communication / Reset receiver* and click **Reset**.

Examples

The following examples show how the Trimble R7 uses the default settings and special application files in various situations.

Default behavior

The factory defaults specified above are applied whenever you start the receiver. If a Power Up file is present in the receiver, its settings are applied immediately after the default settings, so you can use a Power Up file to define your own set of defaults.

When you turn the receiver on and ...	then logging settings are ...	and logging ...
it is the first time that the receiver has been used	the factory defaults	does not begin automatically
you have reset the receiver to its factory defaults	the factory defaults, or those in the Power Up file ^a	does not begin automatically
you have performed a full reset	the factory defaults, because resetting deletes any Power Up file	does not begin automatically

^aA factory default setting is only used if the setting is not defined in the Power Up file.

Power up settings

When you turn the receiver off, any changes that you have made to logging settings are lost and these settings are returned to the factory defaults. Other settings remain as defined in the Current file. The next time you turn on the receiver, the receiver checks for a Power Up file and, if one is present, applies the settings in this file.

When you use (P) to turn the receiver off then on again and ...	then logging settings are ...	and all other settings are ...
you changed the receiver settings by applying an application file	the factory defaults	the last settings used
you changed the receiver settings using configuration software	the factory defaults	the last settings used
there is a Power Up application file in the receiver	the factory defaults, or those in the Power Up file ^a	the last settings used, or those in the Power Up file ^a

^aA factory default setting is used only if the setting is not defined in the Power Up file.

Logging after power loss

If the Trimble R7 loses power unexpectedly, when power is restored the receiver tries to return to the state it was in immediately before the power loss. The receiver does not reset itself to defaults or apply any Power Up settings. If the receiver was logging when power was lost unexpectedly, it resumes logging when power is restored.

However, when you switch the receiver off using (P), the receiver behaves as if you pressed (D) to stop logging before you pressed (P). In this case, when power is restored normally, logging does not begin until you start it manually.

When the receiver is logging data and then loses power ...	then when power is restored, data logging ...	and logging settings are ...	and all other settings are ...
unexpectedly	resumes automatically	the last settings used	the last settings used
when you press (P)	does not resume	the factory defaults	the last settings used

Disabling logging

You can disable logging by setting the receiver's data logging and position logging rates to Off. However, if you press (D) while logging is disabled, the receiver will still log data, using the default logging settings.

When you have disabled logging ...	then if you press (D) to start logging, logging settings are ...
using the Trimble Survey Controller or GPS Configurator software	the factory defaults
in the Power Up application file	the factory defaults

Application files

You can use application files to change the settings in the receiver. Sending an application file to the receiver does not necessarily apply the file's settings; you can apply a file's settings at any time after sending it to the receiver. You can also define timed application files. A timed application file contains receiver settings, but also includes a date and time when it is automatically activated.

If there is a timed application file on the Trimble R7, the receiver automatically applies the file's settings and begins logging (if logging settings are included in the file) at the specified time. If the receiver is in Sleep mode, it wakes up five minutes before the start time of the timed application file, and then begins logging, if required, at the specified start time.

When you send an application file to the receiver and ...	then the receiver settings are changed ...
you apply the file's settings immediately	as soon as you send the file to the receiver
you apply the file later	as soon as you apply the file
it is a timed application file	at the specified activation time

Cables and Connectors

In this chapter:

- Introduction
- Port 1, 2, and 3 Connectors
- Power/serial Data Cable
- Event/PPS Cable
- GPS Antennas and Cables

Introduction

This chapter provides pinout information for the Trimble R7 receiver standard and optional cables. This information can be used to build special cables for connecting the Trimble R7 to devices and instruments not supported by the standard and optional cables.

Port 1, 2, and 3 Connectors

Figure 10.1 shows the location of the Trimble R7 serial ports.

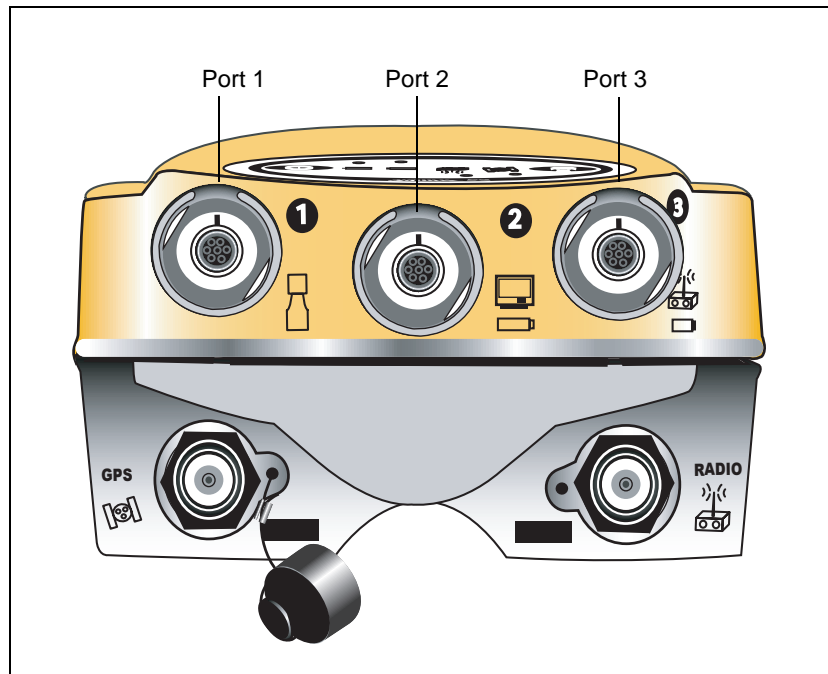

Figure 10.1 Trimble R7 serial ports

Figure 10.2 gives pinout requirements for the connector labeled Port 1. The pin locations for the Port 2 and Port 3 connectors are identical.

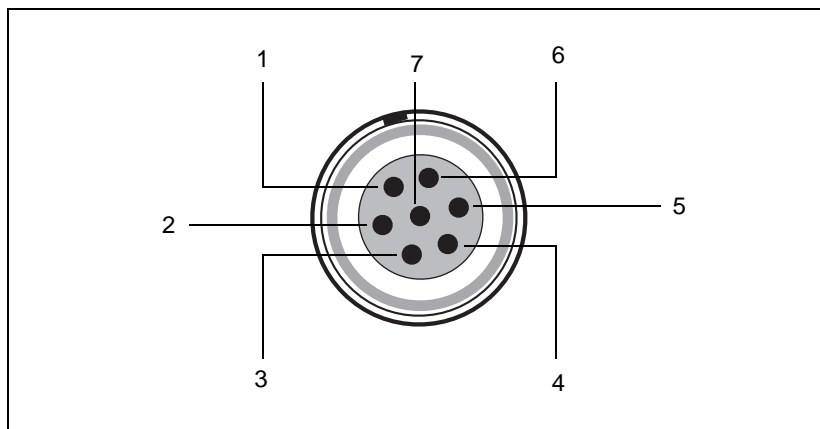

Figure 10.2 Pinout connectors

Table 10.1 describes the pinout functionality.

Table 10.1 Trimble R7 port pinouts

Pin	Pinout function		
	Port 1 (TSC1/TSCe controller, event, or computer)	Port 2 (Power in, computer, PPS, or event)	Port 3 (External radio or power in)
1	Signal GND	Signal GND	Signal GND
2	GND	GND	GND
3	TX data out (TXD1)	TX data out (TXD2)	TX data out (TXD3)
4	RTS1	1PPS	RTS3
5	CTS1/Event 2	Event 1	CTS3
6	Power Out (+)	Power In (+)	Power In/Out (+)
7	Serial data in (RXD1)	Serial data in (RXD2)	Serial data in (RXD3)

Power/serial data cable

Table 10.2 gives pinout information for the power/serial data cable (PN 32345), which is supplied with the Trimble R7.

Table 10.2 Power/serial data cable pinouts

Lemo 0-shell connector 7 Pin		Direction	DE9-F connector 7 Conductors			Power lead 2 Conductors	
Pin	Function		Pin	Color	Function	Color	Function
1	Signal ground	↔	5	Brown	Signal ground		
2	GND	→				Black	V-OUT
3	TXD	→	2	Orange	TXD		
4	RTS/TXD	→	8	Blue	RTS		
5	CTS/RXD	←	7	Green	CTS		
6	PWR	←				Red	Power IN (+)
7	RXD	←	3	Yellow	TXD		

Note – Table 10.2 assumes that the cable is attached to the connector labeled Port 1 or Port 3.

Event Marker/1PPS Cable

The event marker/1PPS cable shown in Figure 10.3 provides a breakout box with two BNC (female) connectors for providing 1PPS input and event marker output.

Connect a device that accepts 1PPS output pulses to the BNC connector labeled 1PPS on the breakout box. Connect a device that outputs event marker pulses to the Trimble R7, such as a photogrammetric camera, to the BNC connector labeled Event Marker on the breakout box.

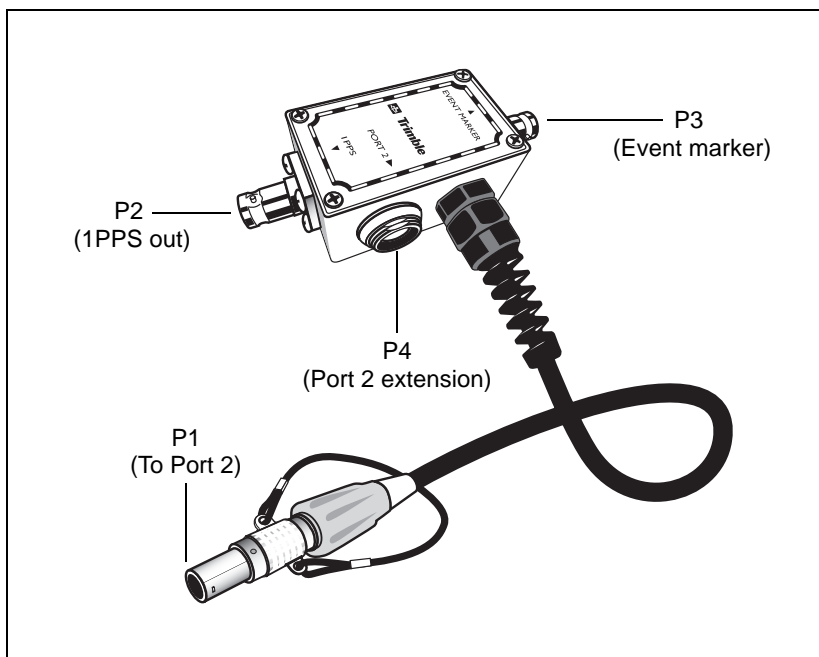

Figure 10.3 Event marker/1PPS cable

In addition, the breakout box includes a Lemo 7-pin connector to extend serial communications and/or power on Port 2. Because the BNC connectors are used to service the event marker and 1PPS features, pins 4 (1PPS) and 5 (Event Marker) are inactive on the Lemo connector.

For Port 2 pinouts, see Port 1, 2, and 3 Connectors, page 102. For more information on 1PPS input and event marker output, see Chapter 11, Event Marker Input and 1PPS Output.

Table 10.3 gives pinout information for the event marker/1PPS cable which is supplied with the Trimble R7. The event marker/1PPS cable is only used with the Trimble R7 connectors labeled Port 1 (for event marker output) and Port 2.

Table 10.3 Event marker/1PPS cable pinouts

P1: Lemo 7-Pin Port 2 Trimble R7		Direction	P2: BNC-F connector (1PPS)	P3: BNC-F connector (Event marker)	P4: Lemo 7s Port 2 extension	
Pin	Trimble R7 function		Pin	Pin	Pin	Function
1	Signal ground	←			1	Signal ground
2	GND	→	GND	GND	2	GND
3	Serial data out (TXD2)	←			3	Serial data in (TXD2)
4	1PPS	←	Center pin		4	No Connect
5	Event Marker	↔		Center pin	5	No Connect
6	Power IN (+)	→			6	Power IN (+)
7	Serial data in (RXD2)	←			7	Serial data out (RXD2)

GPS Antennas and Cables

The antenna that a receiver uses to collect satellite signals is sometimes called a GPS antenna to distinguish it from a radio antenna. Radio antennas are used for communication between receivers and external networks or systems.

Note – To use older models of antennas, such as the Choke Ring or Micro-Centered L1/L2 antennas, with a Trimble R7, you need to use an antenna power adapter and an external power source for the antenna. For more information, see Antennas, page 45.

Connect the receiver to its GPS antenna using the yellow TNC connector. Use a coaxial cable with a right-angle TNC plug at the antenna end.

If the antenna cable length is ...	use ...
up to 15 meters (45 feet)	RG-58 cable
up to 30 meters (100 feet)	RG-214 cable
over 30 meters (100 feet)	one of the following: <ul style="list-style-type: none"> • in-line amplifier • semi-rigid coaxial cable • a low-loss cable assembly

10 Cables and Connectors

Event Marker Input and 1PPS Output

In this chapter:

- Introduction
- Event Marker Input
- 1PPS Output

Introduction

The Trimble R7 receiver can accept event marker input on Port 1 and Port 2, and can generate 1PPS output on Port 2.

Event Marker Input

Event marker input is used to log a precise GPS time tag whenever an externally generated pulse, such as one generated at the time of the shutter closing from a photogrammetric camera, is received.

The event is triggered when the source pulse voltage transitions between 1.0 V DC and 2.0 V DC in less than 100 nsec. Trimble recommends that you use TTL level inputs. You can configure the receiver to recognize either a positive (rising) or negative (falling) voltage as the leading edge of a pulse. The accuracy of the associated time tag recorded for an event is determined by the GPS accuracy (typically less than 1 μ sec.).

The Trimble R7 records each event in the current data file. This record includes the port on which the event was received.

Enabling and configuring event marker input

To enable or configure the event marker input function, you need either GPS Configurator or Configuration Toolbox.

In real time

You can use GPS Configurator to configure a Trimble GPS receiver connected to your office computer. For more information, see GPS Configurator Software, page 78, or refer to the GPS Configurator Help.

To enable event marker input:

1. Connect the computer to the Trimble R7 receiver.
2. Press  to turn on the receiver.



3. To start GPS Configurator, click , then select *Programs / Trimble / GPS Configurator / GPS Configurator*.
The *GPS Configurator* dialog appears and the software automatically connects to the Trimble R7 receiver.
4. In the *General* tab, select the *Event marker* check box.
5. Select the appropriate option, Positive slope or Negative slope, depending on the type of pulse the external device uses.
6. Click **Apply**.
GPS Configurator sends the new configuration information to the receiver, and the receiver starts to accept event marker input.
7. Click **OK** to exit GPS Configurator.
The software disconnects from the receiver.

Using an application file

Configuration Toolbox lets you create an application file containing the appropriate configuration instructions for event marker input. You can then transfer that file to the Trimble R7 to enable event marker input.

For more information, see Configuration Toolbox Software, page 80, or refer to the Configuration Toolbox Help.

To create an application file that enables event marker input:

1. Connect the computer to the Trimble R7 receiver.
2. Press  to turn on the receiver.
3. To start Configuration Toolbox, click , then select *Programs / Trimble / Configuration Toolbox / Configuration Toolbox*.

The main *Configuration Toolbox* window appears.

4. Select *File / New / Trimble R7* to display the *Configuration File* dialog.
5. From the *Available* list select Device, then click **Add**.

6. Complete the dialog as shown below. In the *Triggering Edge* field, select Positive or Negative, depending on which type of pulse the external device uses:

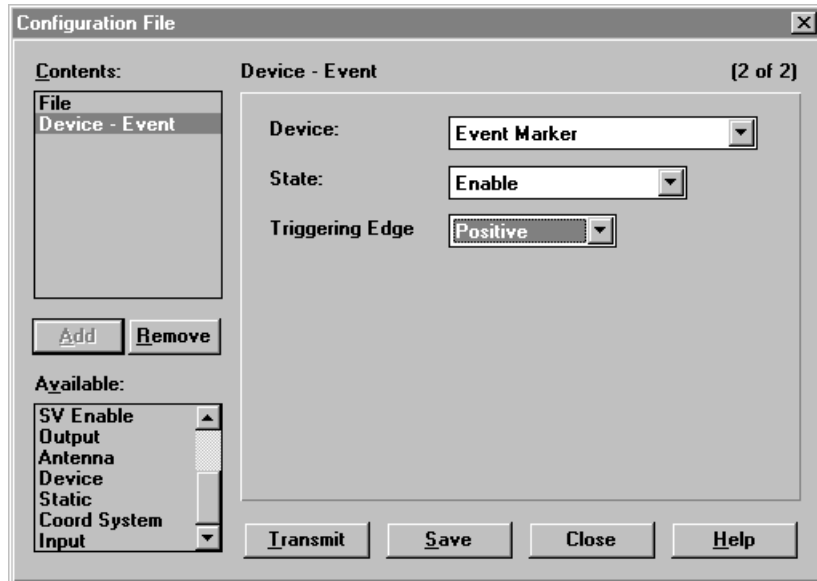

7. To save the application file to your computer, click **Save**.
8. Click **Transmit** to send the application file to the connected receiver. The message Communicating with receiver appears, followed by a message giving details of the transfer.
9. Click **Close** to exit the *Configuration File* dialog.
10. If you have not saved the application file, a message appears, prompting you to save your changes.
11. Select *File / Exit* to close Configuration Toolbox.

1PPS Output

The Trimble R7 receiver can output a one pulse per second (1PPS) time strobe with an associated ASCII time tag output. The pulse is output through Port 2 of the receiver using the event marker/1PPS cable.

1PPS pulse definition

The leading edge of the pulse coincides with the beginning of each UTC second, as shown in Figure 11.1. The pulse is driven by an RS-422 driver between nominal levels of 0 V and 4 V. The leading edge is positive, rising from 0 V to 4 V.

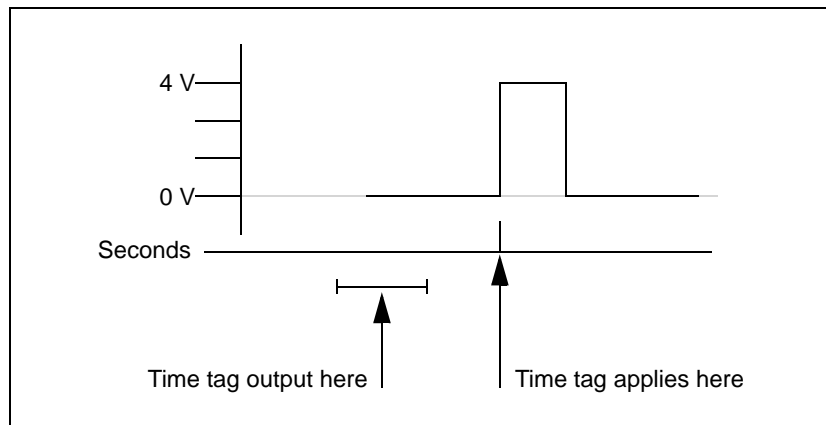

Figure 11.1 Time tag relation to 1PPS wave form

The pulse is approximately 8 μ sec wide, with rise and fall times of about 100 nsec. Resolution is approximately 40 nsec, but several external factors limit accuracy to approximately ± 1 μ sec:

- Position errors, especially with user-entered reference. Each meter of error can result in 3 nsec of error in the 1PPS pulse.
- Antenna cable length. Each meter of cable adds a delay of about 2 nsec to satellite signals, and a corresponding delay in the 1PPS pulse.

ASCII time tag definition

Each time tag is output about 0.5 second before the corresponding pulse, as shown in Figure 11.1. Time tags are in ASCII format on a user-selected serial port. The format of a time tag is:

UTC yy.mm.dd hh:mm:ss ab

Where:

- *UTC* is fixed text.
- *yy.mm.dd* is the year, month, and date.
- *hh:mm:ss* is the hour (on a 24-hour clock), minute, and second. The time is in UTC, not GPS time.
- *a* is the position-fix type:
 - 1 = 2D Position Fix for E,N only
 - 2 = 3D Position Fix
 - 3 = Single SV Clock-only fix
 - 4 = Automatic Mode
 - 5 = Reference Station Position
 - 6 = Two-Dimensional with Fixed Clock
 - 7 = Overdetermined solution for Clock-only
- *b* is the number of satellites being tracked: 1 to 9, “:” (for 10), “;” (for 11), or “<” (for 12).
- Each time tag is terminated by a *carriage return, line feed* sequence.

A typical printout looks like this:

UTC 93.12.21 20:21:16 56

UTC 93.12.21 20:21:17 56

UTC 93.12.21 20:21:18 56

If *a* and *b* are ??, the time is based on the receiver clock because the receiver is not tracking satellites. The receiver clock is less accurate than time readings extracted from satellite signals.

Enabling and configuring 1PPS output

To enable or configure the 1PPS output function, you need either GPS Configurator or Configuration Toolbox.

In real time

You can use GPS Configurator to configure a Trimble GPS receiver connected to your office computer. For more information, see GPS Configurator Software, page 78, or refer to the GPS Configurator Help.

To enable 1PPS output:

1. Connect the computer to the Trimble R7 receiver.
2. Turn on the receiver.
3. To start GPS Configurator, click  **Start**, then select *Programs / Trimble / GPS Configurator / GPS Configurator*.

The *GPS Configurator* dialog appears and the software automatically connects to the receiver.

4. Select the *Serial outputs* tab.
5. Select the *1PPS (port 2 only)* check box.
6. If you want ASCII time tags enabled, select the check box and choose an output port.

7. Click **Apply**.
GPS Configurator sends the new configuration information to the receiver, and the receiver starts to generate 1PPS output on Port 2.
8. Click **OK** to exit GPS Configurator.
The software disconnects from the receiver.

Using an application file

Configuration Toolbox lets you create an application file containing the appropriate configuration instructions for 1PPS output. You can then transfer that file to the Trimble R7 to enable 1PPS output.

For more information, see Configuration Toolbox Software, page 80, or refer to the Configuration Toolbox Help.

To create an application file for 1PPS output:

1. Connect the computer to the Trimble R7 receiver.
2. Turn on the receiver.
3. To start Configuration Toolbox, click  **Start**, then select *Programs / Trimble / Configuration Toolbox / Configuration Toolbox*.

The main *Configuration Toolbox* window appears.

4. Select *File / New / Trimble R7* to display the *Configuration File* dialog.
5. From the *Available* list, select Device, and then click **Add**.
6. From the *Device* field, select 1 Pulse Per Second.

- From the *State* field, select Enable:

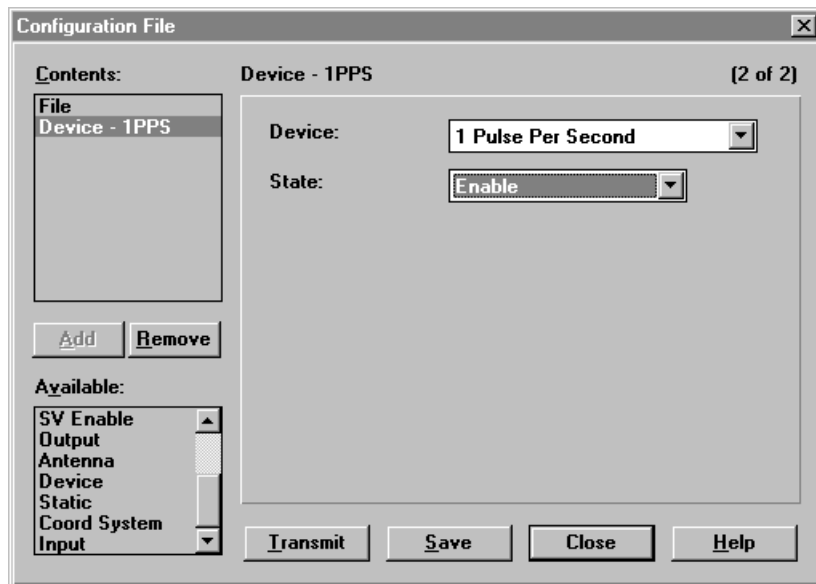

- If you want to save the application file to your computer, click **Save**.
- Click **Transmit** to send the application file to the connected receiver. The message Communicating with receiver appears, followed by a message box giving details of the success or failure of the transfer.
- Click **Close** to exit the *Configuration File* dialog.
- If you have not saved the application file, a message appears, prompting you to save your changes.
- Select *File / Exit* to close Configuration Toolbox.

SECTION

II

TRIMBLE R8 GPS RECEIVER

Overview

In this chapter:

- Introduction
- Features
- Use and Care
- COCOM Limits

Introduction

This chapter introduces the Trimble R8 GPS receiver. This receiver is designed for GPS surveying applications. The receiver incorporates a GPS antenna, receiver, internal radio, and battery in a rugged light-weight unit that is ideally suited as an all-on-the-pole RTK rover. Three LEDs allow you to monitor the satellite tracking, radio reception, data logging status, and power. Bluetooth technology provides cable-free communications between receiver and controller. The Trimble R8 receiver provides 24 total channels of L1/L2 satellite tracking, and supports logging of raw GPS observables to the handheld controller for post-processed applications.

The Trimble R8 is available as a standalone rover, base station, or as part of the GPS Total Station® system, offering maximum versatility in the system configuration to meet your specific requirements.

Features

The receiver provides the following features:

- Trimble R-track technology, which allows the receiver to track the L2 Civil signal (L2C)
- Centimeter-accuracy, real-time positioning with RTK/OTF data, up to 10 Hz position updates
- Submeter-accuracy, real-time positioning using pseudorange corrections
- Adaptive dual-frequency RTK engine
- WAAS/EGNOS capability
- Automatic OTF (on-the-fly) initialization while moving

- Single lithium-ion rechargeable battery
- Cable-free Bluetooth communications with the Trimble Attachable Control Unit (ACU), or TSCe™ with Bluecap module
- Two RS-232 serial ports for:
 - NMEA output
 - RTCM SC-104 input and output
 - Trimble Format (CMR & CMR Plus) input and output
- One TNC port for connecting to a radio antenna
- 6 Mb internal memory for data storage

Use and Care

The Trimble R8 receiver is designed to withstand the rough treatment that typically occurs in the field. However, the receiver is a high-precision electronic instrument and should be treated with reasonable care.



Warning – Operating or storing the Trimble R8 receiver outside the specified temperature range can damage it. For more information, see Chapter 17, Specifications.

High-power signals from a nearby radio or radar transmitter can overwhelm the receiver circuits. This does not harm the instrument, but it can prevent the receiver electronics from functioning correctly. Avoid using the receiver within 400 meters of powerful radar, television, or other transmitters. Low-power transmitters such as those used in cellphones and two-way radios normally do not interfere with receiver operations.

For more information, contact your local Trimble distributor.

COCOM Limits

The U.S. Department of Commerce requires that all exportable GPS products contain performance limitations so that they cannot be used in a manner that could threaten the security of the United States. The following limitations are implemented on the Trimble R8 receiver.

Immediate access to satellite measurements and navigation results is disabled when the receiver's velocity is computed to be greater than 1000 knots, or its altitude is computed to be above 18,000 meters. The receiver continuously resets until the COCOM situation is cleared.

Setting up the Receiver

In this chapter:

- Introduction
- Parts of the Receiver
- Setup Guidelines
- Pole-mounted Setup
- Other System Components

Introduction

This chapter provides general information on setup, connection, and cabling for the Trimble R8 receiver.

Parts of the Receiver

All operating controls on the Trimble R8 receiver are located on the front panel. Serial ports and connectors are located on the bottom of the unit.

Front panel

Figure 13.1 shows a front view of the Trimble R8 receiver. The front panel contains the three indicator LEDs, and the power button.



Figure 13.1 Trimble R8 receiver front panel

The power button controls the receiver's power on or off functions.

The indicator LEDs show the status of power, satellite tracking, and radio reception. For more information, see LED Behavior, page 137.

Lower housing

Figure 13.2 shows the lower housing of the Trimble R8 receiver. The lower housing contains the two serial ports, one TNC radio antenna connector, the removable battery compartment and the 5/8-11 threaded insert.

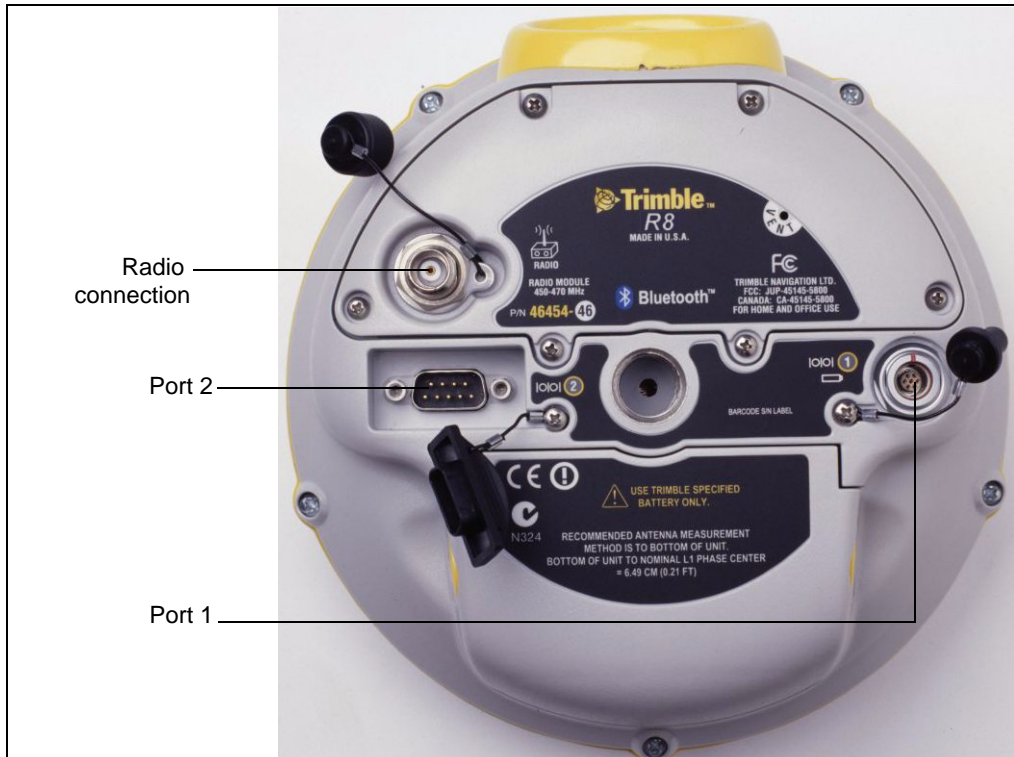





Figure 13.2 Trimble R8 lower housing

Each port or connector on the Trimble R8 receiver is marked with an icon to indicate its main function, as shown in Table 13.1.

Table 13.1 Trimble R8 receiver ports

Icon	Name	Connections
	Port 1	Device, computer, external radio, power in
	Port 2	Device, computer, external radio
	RADIO	Radio communications antenna

Port 1 is a 7-pin 0-shell LEMO connector that supports RS-232 comms and external power input. Port 1 has no power outputs.

Port 2 is a DB-9 male connector that allows for full 9-pin RS-232 comms. Port 2 does not support power in or out. For more information on default port settings, see Chapter 18, Default Settings. For more information on connector pinouts, see Chapter 19, Cables and Connectors.

The TNC port connector is for connecting a radio antenna to the Trimble R8 internal radio. A whip “rubber duck” antenna is supplied with the system for units with internal UHF or 900 MHz radios. This connector is not used if you are using an external radio receiver. For more information on connecting the Trimble R8, see the following sections in this chapter.

Setup Guidelines

Consider the following guidelines when setting up the Trimble R8 receiver.

Environmental conditions

Although the Trimble R8 receiver has a waterproof housing, reasonable care should be taken to protect the unit. Avoid exposure to extreme environmental conditions, including:

- Water
- Heat greater than 65 °C (149 °F)
- Cold less than -40 °C (-40 °F)
- Corrosive fluids and gases

Sources of electrical interference

Avoid the following sources of electrical and magnetic noise:

- Gasoline engines (spark plugs)
- Televisions and PC monitors
- Alternators and generators
- Electric motors
- Equipment with DC-to-AC converters
- Fluorescent lights
- Switching power supplies

General guidelines

The following guidelines apply whenever you set up your receiver for operation:

- When plugging in a Lemo cable, make sure that the red dots on the receiver port and the cable connector line up. *Never* use force to plug cables in, as this may damage the connector pins.
- When disconnecting a Lemo cable, grasp the cable by the sliding collar or lanyard and pull the cable connector straight out of the port. Do not twist the connector or pull on the cable itself.
- To securely connect a TNC cable, align the cable connector with the receiver receptacle, then thread the cable connector onto the receptacle until it is snug.
- To insert the internal battery place the battery in the battery compartment, ensuring that the contact points are in the correct position to align with the contacts in the receiver. Slide the battery and compartment as a unit upward into the receiver until the battery compartment latches are locked into position.

Pole-Mounted Setup

Figure 13.3 shows the pole-mounted setup for the Trimble R8 receiver. To mount the receiver on a range pole:

1. Thread the unit onto the range pole.
2. Attach the controller bracket to the pole.
3. Insert the controller into the bracket.

4. If using the TSC1™, connect the data-i/o cable from Port 1 of the receiver to a port on the TSC1. If using the Trimble ACU, or TSCe with Bluecap module, no cabling is required, as shown in Figure 13.3.

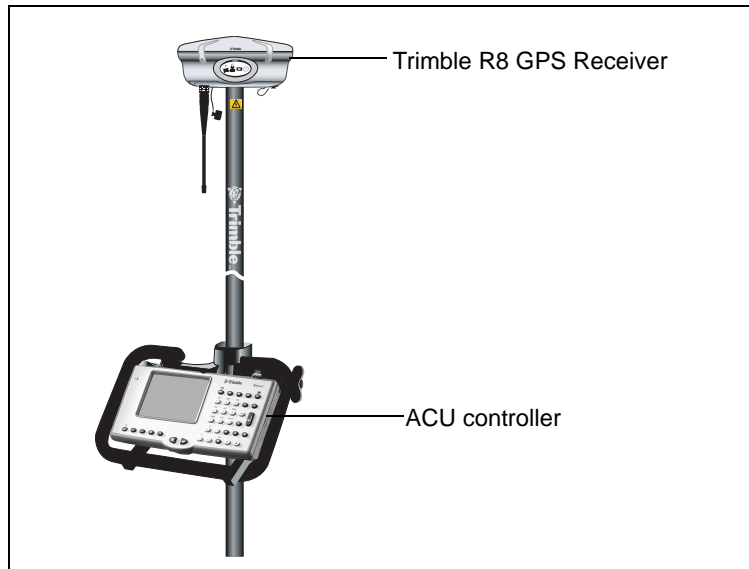

Figure 13.3 Trimble R8 receiver pole-mounted setup

Other System Components

This section describes optional components that you can use with the Trimble R8 receiver.

Radios

Radios are the most common data link for Real-Time Kinematic (RTK) surveying. The Trimble R8 is available with an optional internal radio in either the 450 or 900 MHz UHF band. You can also connect an external radio to either port, whether the internal radio is installed or not.

The Trimble R8 receiver supports the following Trimble base radios with the internal 450 MHz or 900 MHz UHF radios:

- TRIMMARK™ 3
- TRIMMARK IIe
- TRIMTALK™ 450S
- SiteNet™ 450
- SiteNet 900

Internal Radio Setup

You can configure the receiver optional internal radio using any of the following software:

- GPS Configurator
- WinFlash
- Trimble Survey Controller™

For more information, refer to the GPS Configurator Help, the WinFlash Help, or the *Trimble Survey Controller User Guide*.

By default, the internal radio has only a few “test” frequencies installed at the factory. Use WinFlash to program your licensed frequencies prior to using the receiver. For more information, see WinFlash Software, page 155.

Cellular modems and external radios

You can use a cellular modem or external radio instead of the internal radio as your data communications link.

To connect a cellular modem to a Trimble R8 receiver, you need the following:

- A Trimble R8 receiver.
- A cellular modem, or a cellphone that can transmit and receive data.

- Serial (cellphone to DB9) cable (supplied with the cellular modem or phone).

Note – For more information, refer to the document *Using Cellular and CDPD Modems for RTK*, which is available from the Trimble website.

- Port 2 of the Trimble R8 supports full RS-232 protocol, and should function properly with most cellular phone cables. Some cellular units may require custom cabling.

Alternatively, the Trimble R8 also supports a cable-free Bluetooth connection with Bluetooth enabled cell phones.

For more information on using a cellular modem as a data link, refer to the *Trimble Survey Controller User Guide*.

To connect an external radio modem to a Trimble R8 receiver, you need the following:

- A Trimble R8 Receiver.
- An external radio capable of receiving and decoding Trimble data packets.
- Serial cable for either Port 1 or Port 2 of the Trimble R8, as supplied by the radio manufacturer.
- Radio mount for the range pole.

General Operation

In this chapter:

- Introduction
- Button Functions
- LED Behavior
- Starting and Stopping the Receiver
- Logging Data
- Resetting to Defaults
- Batteries and Power

Introduction

Figure 14.1 shows the Trimble R8 receiver front panel controls for the power on/off functions, or receiver reset. The LEDs provide power, radio, data logging, and SV tracking status information.

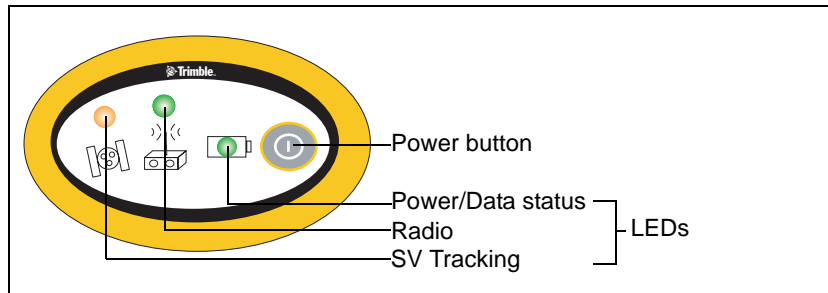

Figure 14.1 Controls and LEDs on front panel of the Trimble R8 receiver

Button Functions

The Trimble R8 receiver has only one button, the Power button, represented in this manual by **(P)**. Use **(P)** to switch the receiver on or off, and to perform other functions, as described in Table 14.1.

Table 14.1 Power button functions

Action	Power button
Turn the receiver on	Press
Turn the receiver off	Hold for 2 seconds
Delete the ephemeris file	Hold for 15 seconds
Reset the receiver to factory defaults	Hold for 15 seconds
Delete application files	Hold for 30 seconds

***Note** – The term “press” indicates that you should press the button and release it immediately. The term “hold” indicates that you should press the button and hold it down until the time indicated has elapsed.*

LED Behavior

The three LEDs on the front panel of the receiver indicate various operating conditions. Generally, a lit or slowly flashing LED indicates normal operation, a LED that is flashing quickly indicates a condition that may require attention, and an unlit LED indicates that no operation is occurring. The following table defines each possible LED state.

The term ...	means that the LED ...
Slow flash	alternates on/off for 500 milliseconds.
Fast flash	alternates rapidly on/off for 100 milliseconds
On	is lit steady
Off	is unlit

LED flash patterns

The following table details the possible flash patterns to indicate various states of receiver operation.

Receiver mode	Power LED Green	Radio LED Green	Satellite LED Amber
Receiver OFF	OFF	OFF	OFF
Receiver ON:			
Healthy power	ON	N/A	N/A
Low power	Fast flash	N/A	N/A
Tracking <4 SVs	ON	N/A	Fast flash
Tracking >4 SVs	ON	N/A	Slow flash
Logging data internally	Flashes off every 3 seconds	N/A	N/A
Receiving valid data packets	ON	Slow flash	N/A
No data packets	ON	OFF	N/A
Receiver in Monitor	ON	Slow flash	ON

Note – If a column shows “N/A”, that specific LED may or may not be on, but it is not relevant to that particular mode.

Starting and Stopping the Receiver

To turn on the receiver, press **[P]**.

To turn off the receiver, hold down **[P]** for two seconds.

Logging Data

You can log data internally or to a Trimble controller.

Logging internally

The Trimble R8 receiver logs GPS data internally on 6 Mb of internal memory.

You can then use the Trimble Data Transfer utility to transfer logged data files to the office computer. The transferred files are in Trimble DAT (.dat) format.



Warning – The Trimble R8 allows for a maximum of 512 files on the internal memory. The filenames must be in 8.3 format, otherwise files copied to the internal memory may cause data corruption or loss of data when logging.

Data is logged using the current logging settings configured in the receiver. Data files logged internally are named automatically.

To begin internal logging, you must use a Trimble controller, or the GPS Configurator or Configuration ToolBox™ utility. The Trimble R8 receiver does not have an internal clock, so you cannot conduct timed sessions.

Note – When the internal memory is full, the receiver stops logging data, and the Logging/Memory LED switches off. Existing data files are not overwritten.

Table 14.2 shows approximate storage requirements for different logging rates. The values shown are for a one-hour logging session with six satellites visible.

Table 14.2 Storage requirements

Logging rate	Memory required
10 Hz	2,588 KB
1 Hz	335 KB

Table 14.2 Storage requirements (continued)

Logging rate	Memory required
5 seconds	87 KB
15 seconds	37 KB

Logging to a Trimble controller

When the Trimble R8 receiver is connected to a Trimble controller, you can log GPS data from the receiver to the controller, or to a PC card inserted in the controller. When you use a Trimble controller, you do not use the receiver's controls. Instead, you use the controller functions to set logging options, specify filenames, and control when logging occurs.

Data is stored in job files, which can be transferred to your office computer using Trimble's Data Transfer utility.

For more information on logging data from a receiver using a Trimble controller refer to the user guide for your particular controller.

Resetting to Defaults

To reset the receiver to its factory default settings, hold down **[P]** for at least 15 seconds.

For more information, see Default Settings, page 167.

Batteries and Power

The Trimble R8 receiver can be powered either by its internal battery or by an external power source connected to Port 1. Typically, one internal 1.8 ampere-hour battery provides approximately 5.5 hours of operation during an RTK survey using the internal radio.

If an external power source is connected to Port 1 it is used in preference to the internal battery. When there is no external power source connected, or if the external power supply fails, the internal battery is used.

The receiver is supplied with two rechargeable lithium-ion batteries, and a dual battery charger. The two batteries charge sequentially and take approximately four hours each to fully charge.

Battery charging and storage

Note – All battery types discharge over time when they are not being used. Batteries also discharge faster in colder temperatures. If a lithium-ion battery is to be stored for long periods of time, make sure it is fully charged before storing and re-charged at least every three months.

To protect the battery from deep discharge (5 volts or less), the Trimble R8 system is designed to switch batteries or cease drawing power when the battery pack discharges to 5.9 volts.

A battery that has reached the deep discharge level cannot be recharged and must be replaced. The following recommendations provide optimal performance and extend the life of your batteries:

- Fully charge all new batteries prior to use.
- Do not allow the batteries to discharge below 5 volts.
- Keep all batteries on continuous charge when not in use. Batteries may be kept on charge indefinitely without damage to the receiver or batteries.
- Do not store batteries in the receiver or external charger unless power is applied.

If you must store the batteries, fully charge them before storing and then recharge them at least every three months.

Power output

The Trimble R8 receiver does not supply power from either of its two ports.

Firmware

A receiver's *firmware* is the program inside the receiver that controls receiver operations and hardware. You can upgrade the firmware for the Trimble R8 receiver using the WinFlash utility provided on the *Trimble R7, Trimble R8, 5700, and 5800 GPS Receivers CD*.

For more information, see WinFlash Software, page 155.



Warning – Upgrading the firmware deletes all application files on the receiver.

Configuration

In this chapter:

- Introduction
- Configuring the Receiver in Real Time
- Configuring the Receiver Using Application Files
- Application Files

Introduction

The Trimble R8 receiver has no controls for changing settings. To configure the receiver, use external software such as GPS Configurator, WinFlash, Configuration Toolbox, or Trimble Survey Controller.

There are two ways to configure the receiver. You can:

- configure the receiver in real time
- apply the settings in an application file

This chapter provides a brief overview of each of these methods and describes the contents and use of application files.

Configuring the Receiver in Real Time

GPS Configurator, Configuration Toolbox, and Trimble Survey Controller all support real-time configuration of the Trimble R8 receiver.

When you configure the receiver in real time, you use one of these software applications to specify which settings you want to change. When you apply the changes, the receiver settings change immediately.

Any changes that you apply to the receiver are reflected in the current application file, which is always present in the receiver. The current application file always records the most recent configuration, so if you apply further changes (either in real time or using an application file) the current file is updated and there is no record of the changes that you applied originally.

For more information on configuring the receiver in real time, see Chapter 16, Software Utilities.

Configuring the Receiver Using Application Files

An application file contains information for configuring a receiver. To configure a receiver using an application file, you need to create the application file, transfer it to the receiver, and then apply the file's settings. Use the Configuration Toolbox software to perform all these tasks.

For more information on applying application files, see Chapter 16, Software Utilities.

Application Files

An application file is organized into records. Each record stores configuration information for a particular area of receiver operation. Application files can include the following records:

- File Storage
- General Controls
- Serial Port Baud/Format
- Reference Position
- Logging Rate
- SV Enable/Disable
- Output Message
- Antenna
- Device Control
- Static/Kinematic
- Input Message

An application file does not have to contain all of these records. When you apply an application file, any option that is not included in the records in the file remains at its current setting. For example, if you

apply an application file that only specifies the elevation mask to use, all other settings remain as they were before the application file was applied.

You can store up to twenty different application files in the receiver. You can apply an application file's settings at the time it is transferred to the receiver, or at any time afterwards.

Special application files

The Trimble R8 receiver has three special application files, which control important aspects of the receiver's configuration.

Default application file

The default application file (Default.cfg) contains the original receiver configuration, and cannot be changed. This file configures the receiver after it is reset. You can reset the receiver by holding down **[P]** for at least 15 seconds, or by using the reset option in GPS Configurator.

For more information on the default receiver settings, see Default Settings, page 167.

Although you cannot change or delete the default application file, you can use a power up application file to override any or all of the default settings.

Current application file

The current application file (Current.cfg) reflects the current receiver configuration. Whenever you change the receiver's configuration, either in real time or by applying an application file, the current file changes to match the new configuration.

You cannot delete the current file or change it directly, but every change to the receiver's current configuration is applied to the current file as well.

When you switch off the receiver then turn it on again, all the settings from the current application file are applied, so you do not lose any changes that you have made. The only exceptions are the following logging parameters:

- Logging rate
- Position rate
- Elevation mask

These parameters are always reset to the factory default values whenever the receiver is switched off.

Power Up application file

The power up application file (Power_up.cfg) is used to set the receiver to a specific configuration any time the unit is powered up.

You can specify that the receiver is reset to defaults before the power up settings are applied. This ensures that restarting the receiver always resets it to factory defaults prior to applying the power up application file.

Alternatively, you can specify that the power up settings are applied immediately after the current application file's settings have been applied. Restarting the receiver results in a configuration that uses your default settings for the options you define in the power up file, but the current settings for all other options.

By default, there is no power up application file on the receiver. If you want to use a power up application file, you need to create an application file in Configuration Toolbox and make sure that the *As auto power up file* option is selected in the *File* page. When you transfer this file to the receiver, it is transferred with the name Power_up.cfg, and becomes the new power up file.

The power up file is the only special application file that you can overwrite or delete from the receiver.

Applying application files

An application file's settings do not affect the receiver's configuration until you *apply* the application file. You can do this at the same time that you save the file. Alternatively, you can save the file on the computer or in the receiver, then open it later and apply its settings.

Storing application files

You can store application files that you create in Configuration Toolbox on both your receiver and computer. Each file can, for example, represent a different user sharing the same receiver, or a particular mode of operation or survey style. Saving application files on your computer as well as in your receiver is optional, but it is useful because:

- it gives you a permanent copy of the settings you have sent to a receiver, for audit or your own reference
- you can use the same file to configure multiple receivers identically
- you can use an existing application file as a template for creating other application files with similar settings

Naming application files

The filename that you use to store the application file in the computer and the name under which the file is stored in the receiver are always the same. This makes recognizing and keeping track of your application files easier. If you change the name of the file on the receiver, this changes the filename used to store the application file on your computer. Similarly, if you change the filename on the computer, the name of the file in the receiver will change.

Software Utilities

In this chapter:

- Introduction
- GPS Configurator Software
- Configuration Toolbox Software
- WinFlash Software

Introduction

This chapter provides information on the software utilities that you can use with the Trimble R8 receiver.

GPS Configurator Software

GPS Configurator is office software that configures selected Trimble GPS receivers.

GPS Configurator lets you:

- check current receiver settings and operation
- configure receiver settings with your PC

Installing GPS Configurator

A copy of GPS Configurator is included on the *Trimble R7, Trimble R8, 5700, and 5800 GPS Receivers CD*.

To install the software:

1. Insert the CD into the CD drive on your computer.
2. From the main menu select *Install individual software packages*.
3. Select *Install GPS Configurator vX.XX*.
4. Follow the onscreen instructions.

Configuring the Trimble R8 receiver

To configure a Trimble R8 receiver using GPS Configurator:

1. Connect Port 1 or 2 on the receiver to a serial (COM) port on the computer and apply power.
2. To start GPS Configurator, click  **Start**, then select *Programs / Trimble / GPS Configurator / GPS Configurator*.
3. Select *Trimble R8* in the *Device Type* dialog.

The software automatically establishes a connection with the receiver.

4. Make appropriate selections for your required receiver settings.
For more information, refer to the GPS Configurator Help.
5. Click **Apply**.

The settings in GPS Configurator are applied to the receiver.

Configuration Toolbox Software

Configuration Toolbox is office software that helps you configure selected Trimble GPS receivers.

Configuration Toolbox lets you:

- create and edit application files
- transfer application files to and from the receiver
- manage application files stored in the receiver

For more information, see Application Files, page 145.

Installing Configuration Toolbox

A copy of Configuration Toolbox is included on the *Trimble R7, Trimble R8, 5700, and 5800 GPS Receivers CD*.

To install the software:

1. Insert the CD into the CD drive on your computer.
2. From the main menu select *Install individual software packages*.
3. Select *CToolBox vX.XX*.
4. Follow the onscreen instructions.

Creating and editing application files

You can create an application file and transfer it to the receiver in several different ways. The general workflow includes the following steps:

1. Create and save the application file in Configuration Toolbox.
2. Connect the receiver to the computer and apply power.
3. Open the desired application file in Configuration Toolbox.
4. Transfer this application file to the receiver.

5. Check that the receiver is using the transferred application file.

To create and save an application file to the receiver:

1. To start Configuration Toolbox, click , then select *Programs / Trimble / Configuration Toolbox / Configuration Toolbox*.
2. Select *File / New / Trimble R8*.
3. Specify the receiver settings (for specific information, refer to the Configuration Toolbox documentation).
4. Use *File / Save As* to save the application file:

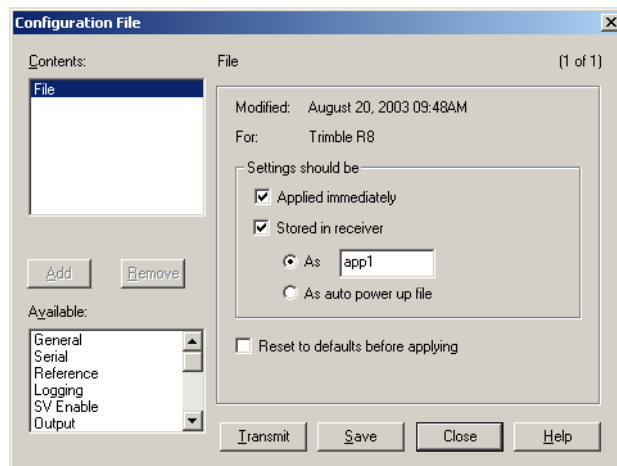

To transfer the application file to the receiver:

1. Connect the power/serial data cable to the receiver, and connect to serial port on your computer.
2. Select *File / Open* to open the desired application file.
3. With the file open and the *Configuration File* dialog open, select *Communications / Transmit File*.

A message appears informing you that the application file has been successfully transferred. If an error occurs, select *Communications / Transmit File* again. This overrides any incompatibility in baud rates and enables successful communication.

4. To check whether the transfer was successful, close the *Configuration File* dialog and select *Communications / Get File*.

A list of all application files in the receiver appears. If you selected *Applied immediately* in the application file, the Current application file will contain the settings in the new file.

5. To apply a different file, select the file you require from the list and then select *Communications / Activate File*.

WinFlash Software

WinFlash communicates with Trimble products to perform various functions including:

- installing software, firmware, and option upgrades
- running diagnostics (for example, retrieving configuration information)
- configuring radios

For more information, online help is also available when using WinFlash.

Note – WinFlash runs on Microsoft Windows 95, 98, NT, 2000, Me, or XP operating systems.

Installing WinFlash

WinFlash can be installed from the *Trimble R7, Trimble R8, 5700, and 5800 GPS Receivers CD*, or from the Trimble website.

Installing WinFlash from the CD

1. Insert the disk into the CD drive on your computer.
2. From the main menu select *Install individual software packages*.
3. Select *Install WinFlash vX.XX with Trimble R8 drivers and firmware*.
4. Follow the on-screen instructions.

Upgrading firmware

Your Trimble R8 receiver is supplied with the latest version of receiver firmware installed. If a later version becomes available, upgrade the firmware installed on your receiver.

WinFlash guides you through the firmware upgrade process. The steps required are described below. For more information, refer to the WinFlash Help.

To upgrade the Trimble R8 receiver firmware:

1. Start WinFlash.

The *Device Configuration* screen appears.

2. From the *Device type* list select *Trimble R8 Receiver*.
3. From the *PC serial port* field select the serial (COM) port on the computer that the receiver is connected to.
4. Click **Next**.

The *Operation Selection* screen appears. The *Operations* list shows all of the supported operations for the selected device. A description of the selected operation is shown in the *Description* field.

5. Select GPS software upgrade and click **Next**.

The *GPS Software Selection* window appears. This screen prompts you to select the software that you want to install on the receiver.

6. Select the latest version from the *Available Software* list and click **Next**.

The *Settings Review* window appears. This screen prompts you to connect the receiver, suggests a connection method, and then lists the receiver configuration and selected operation.

7. If all is correct, click **Finish**.

Based on the selections shown above, the *Software Upgrade* window appears and shows the status of the operation (for example, Establishing communication with the Trimble R8. Please wait ...)

8. Click **OK**.

The *Software Upgrade* window appears again and states that the operation was completed successfully.

9. Click **Menu** to select another operation, or click **Exit** to quit WinFlash.
10. If you click **Exit**, another screen appears asking you to confirm that you want to quit WinFlash. Click **OK**.

Adding frequencies for the 450 MHz internal radio

If your Trimble R8 receiver has the optional internal 450 MHz radio installed, you must use WinFlash to add frequencies to the default list.

To add radio frequencies:

1. Start WinFlash.
The *Device Configuration* screen appears.
2. From the *Device type* list select *Trimble R8 Receiver*.
3. From the *PC serial port* field select the serial (COM) port on the computer that the receiver is connected to.
4. Click **Next**.

The *Operation Selection* screen appears. The *Operations* list shows all of the supported operations for the selected device. A description of the selected operation is shown in the *Description* field.

5. Select **Configure Radio** and click **Next**.

The *Frequency Selection* window appears:

Frequency Selection

You have connected to a Trimble R8 Internal

Frequency Band: 410.0 - 430.0 MHz

Wireless Format

Current Channel: 1 - 419.550 MHz

Wireless Mode: TRIMTALK 450S at 9600 bps

Note: Wireless mode must be common among all radios in your network.

Channel Frequency

Specify Frequency:

419.5500 MHz Add

Selected Frequencies:

Channel	Frequency
1	419.5500
2	420.0000
3	430.0000

Remove
Remove All
Move Up
Move Down

OK
Cancel
Radio Info...
Save...
Print

6. In the *Wireless Format* group, select the appropriate channel and wireless mode. The Wireless Mode must be the same for all radios in your network.
7. In the *Specify Frequency* field, enter the frequency you require.

8. Click **Add**. The new frequency appears in the *Selected Frequencies* list.

***Note** – The frequencies that you program must conform to the channel spacing and minimum tuning requirements for the radio. To view this information, click **Radio Info**. You may select either 12.5 or 25 kHz channel spacing. All radios in your network must use the same channel spacing.*

9. When you have configured all the frequencies you require, click **OK**.

WinFlash updates the receiver radio frequencies and then restarts the receiver.

Configuring the internal 900 MHz radio setup

To configure the internal 900 MHz radio, use one of the following:

- Trimble Survey Controller running on a Trimble controller
- WinFlash (provided on the *Trimble R7, Trimble R8, 5700, and 5800 GPS Receivers CD*)

The internal radio has 40 available networks. You must choose the same network that is configured in the base radio you want to receive from.

Trimble Survey Controller

To configure your radio network using Trimble Survey Controller:

1. Connect to the Trimble R8 receiver with Bluetooth (or the appropriate data cable if necessary).
2. From the main menu on the controller, select *Configuration*.
3. In the dialog that appears, select *Survey styles*, then from the *Type* field, select *RTK*.
4. Select *Rover radio*, then from the *Type* field select *Trimble Internal*.

5. Tap the **Connect** softkey.
6. Once connected, in the *Network number* field enter the number of the network set on your base radio.

Note – The *Base Radio Mode* field is not used here.

7. Tap the **Enter** softkey to complete configuration.

WinFlash

To configure the radio network using WinFlash:

1. Connect the data/power cable to Port 1 on the receiver.
2. Connect the female DE-9 connector on the other end of the data/power cable to a serial (COM) port on the computer.
3. Start WinFlash. The *Device Configuration* dialog appears.
4. From the *Device type* list, select *Trimble R8 Receiver*.
5. From the *PC serial port* field, select the serial port on the computer that the receiver is connected to and click **Next**.
6. From the *Operation selection* dialog, select *Configure radio* and click **Next**.
7. Confirm that your current settings are correct and click **Finish**. The *Configure 900MHz radio* dialog appears.
8. In the *Network number* field, select the same network that is set on your base radio.
9. In the *Country setting* field, select one of the following (according to how your base radio was shipped):
 - Your country (if available). This sets the radio to the a specific frequency range being transmitted by the base radio.
 - A single frequency. This limits the frequencies used to those authorized in your particular country.
10. Click **OK**.

WinFlash updates the radio settings and then restarts the receiver.

Specifications

In this chapter:

- Introduction
- Physical Specifications
- Positioning Specifications
- Technical Specifications

Introduction

This chapter details the specifications of the Trimble R8 receiver.

Physical Specifications

Table 17.1 lists physical specifications for the Trimble R8 receiver.

Table 17.1 Physical specifications

Feature	Specification
Size	19cm (7.5") wide x 10cm (3.9") deep including connectors
Weight: with internal battery and radio	1.21 kg (2.7 lbs)
Battery life (at 20 °C)	Approximately 5.5 hours for one 1.8 ah lithium-ion battery
External Power input	11–28 V DC
Operating temperature	–40 °C to +65 °C (–40 °F to +149 °F) ^a
Storage temperature	–40 °C to +70 °C (–40 °F to +158 °F)
Humidity	100% condensing, unit fully sealed
Casing	Dust-proof, shock- and vibration-resistant

^aReceiver is rated to -40 °C. Batteries are rated to -20 °C.

Positioning Specifications

Table 17.2 lists positioning specifications for the Trimble R8 receiver.

Table 17.2 Positioning specifications

Positioning	Mode	Horizontal accuracy (RMS)	Vertical accuracy (RMS)
RTK (OTF)	Synchronized	1 cm + 1 ppm (× baseline length)	2 cm + 1 ppm (× baseline length)
	Low Latency	2 cm + 2 ppm (× baseline length) ^a	3 cm + 2 ppm (× baseline length) ^a
L1 C/A Code Phase	Synchronized/ Low Latency	.25m + 1ppm RMS	.50m + 1ppm RMS
Static/ FastStatic	N/A	5 mm + 0.5 ppm (× baseline length)	5 mm + 1 ppm (× baseline length)
WAAS	N/A	Less than 5 m ^b	Less than 5 m ^b

^aDepends on radio link latency.

^b3D RMS values depend on WAAS system performance.

Technical Specifications

Table 17.3 lists technical specifications for the Trimble R8 receiver.

Table 17.3 Technical specifications

Feature	Specification
Tracking	24 Channels L1 C/A Code, L2C, L1/L2 Full Cycle Carrier, WAAS/EGNOS support Fully operational during P-code encryption WAAS satellite tracking
Signal processing	Maxwell V architecture Very low-noise C/A code processing Multipath suppression
Start-up	Cold start: < 60 seconds from power on Warm start: < 30 seconds with recent ephemeris
Initialization	Automatic while moving or static
Minimum initialization time	10 sec + 0.5 × baseline length (km)
Communications	Two RS-232 serial ports (Port 1, Port 2,) <ul style="list-style-type: none"> Port 1: Baud Rates up to 115,200 bps Port 2: Baud Rates up to 115,200 bps RTS/CTS flow control negotiation supported on Port 2 only Bluetooth communications with Trimble ACU or TSCe with Bluecap module
Configuration	Via user-definable application files or GPS Configurator
Output formats	NMEA-0183: AVR; GGA; GST; GSV; PTNL,GGK; PTNL,GGK_SYNC; HDT; PTNL,PJK; PTNL,PJT; ROT; PTNL,VGK; VHD; VTG; ZDA GSOFF (Trimble Binary Streamed Output) RT17

Default Settings

In this chapter:

- Introduction
- Default Settings
- Resetting to Factory Defaults

Introduction

All Trimble R8 receiver settings are stored in application files. The default application file, `Default.cfg`, is stored permanently in the receiver, and contains the factory default settings for the receiver. Whenever the receiver is reset to its factory defaults, the current settings (stored in the current application file, `Current.cfg`) are reset to the values in the default application file.

You cannot modify the default application file. However, if there is a power up application file (`Power_Up.cfg`) in the receiver, the settings in this file can be applied immediately after the default application file, overriding the factory defaults.

For more information about application files, see [Application Files](#), page 145.

Default Settings

Table 18.1 defines the default settings for the Trimble R8 receiver, as defined in the default application file.

Table 18.1 Default settings

Function		Factory default
SV Enable		All SVs enabled
General Controls:	Elevation mask	13°
	SNR mask	7
	RTK positioning mode	Low Latency
	Motion	Kinematic
Serial Port 1:	Baud rate	115,200
	Format	8-None-1
	Flow control	None
Serial Port 2:	Baud rate	115,200
	Format	8-None-1
	Flow control	None
Input Setup:	Station	Any
NMEA/ASCII (all messages)		All Ports Off
Streamed output		All Types Off Offset = 00
RT17/Binary		All Ports Off
Reference position:	Latitude	0°
	Longitude	0°
	Altitude	0.00 m HAE
Antenna:	Type	Trimble R8 internal
	Height (true vertical)	0.00 m
	Group	All
	Measurement method	Bottom of mount

Resetting to Factory Defaults

To reset the Trimble R8 receiver to its factory defaults, do one of the following:

- Press and hold down **(P)** on the receiver for 15 seconds.
- In Configuration Toolbox, select *Communication / Reset receiver* and click **Reset**.

Default behavior

The factory defaults specified above are applied whenever you start the receiver. If a Power Up file is present in the receiver, its settings are applied immediately after the default settings, so you can use a Power Up file to define your own set of defaults.

Power up settings

When you turn the receiver off, any changes that you have made to logging settings are lost and these settings are returned to the factory defaults. Other settings remain as defined in the Current file. The next time you turn on the receiver, the receiver checks for a Power Up file and, if one is present, applies the settings in this file.

When you use (P) to turn the receiver off then on again and ...	then logging settings are ...	and all other settings are ...
you changed the receiver settings by applying an application file	the factory defaults	the last settings used
you changed the receiver settings using configuration software	the factory defaults	the last settings used
there is a Power Up application file in the receiver	the factory defaults, or those in the Power Up file ^a	the last settings used, or those in the Power Up file

^aA factory default setting is used only if the setting is not defined in the Power Up file.

Cables and Connectors

In this chapter:

- Introduction
- Port 1 and 2 Connectors
- Power/serial Data Cable

Introduction

This chapter provides pinout information for the Trimble R8 receiver standard and optional cables. This information can be used to prepare special cables for connecting the receiver to devices and instruments not supported by the standard and optional cables.

Port 1 and 2 Connectors

Figure 19.1 shows the location of the Trimble R8 serial ports.



Figure 19.1 Trimble R8 serial ports

Figure 19.2 gives pinout requirements for the connector labeled Port 1.

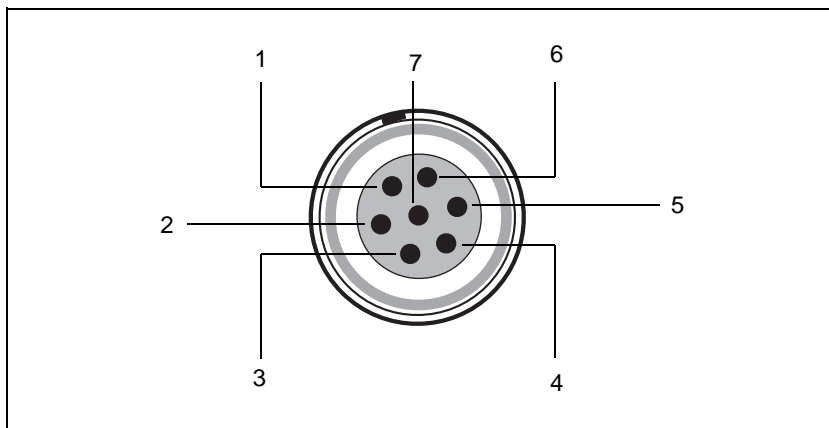

Figure 19.2 Port 1 connector

Figure 19.3 gives pinout requirements for the connector labeled Port 2.

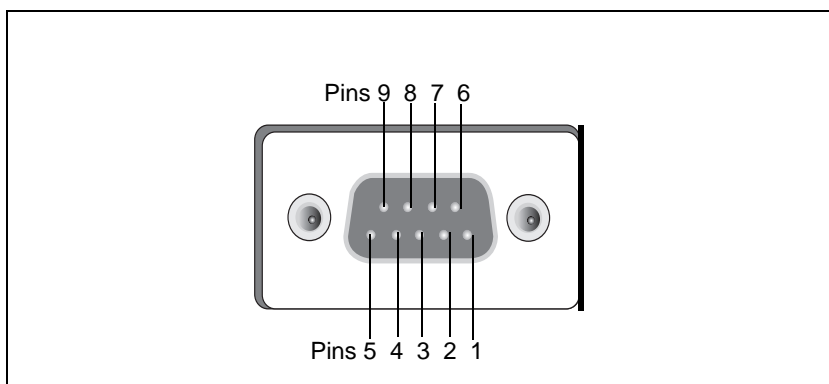

Figure 19.3 Port 2 connector

Table 19.1 describes the pinout functionality.

Table 19.1 Trimble R8 port pinouts

Pin	Pinout function	
	Port 1 - 7-pin Lemo	Port 2 - DB-9
1	Signal ground	DCD
2	- Power ground	RXD
3	TXD	TXD
4	N/C	DTR
5	N/C	Signal ground
6	+ Power in	DSR
7	TRXD	RTS
8	N/A	CTS
9	N/A	Ring indicator

Power/Serial Data Cables

Note – Table 19.2 gives pinout information for the data-I/O cable, (PN 18532) which is supplied with the Trimble R8 receiver

Note – Table 19.2 assumes that the cable is attached to the connector labeled Port 2.

Table 19.2 Data-I/O cable pinouts

DB-9 Female 9 Pin		DB-9 Female 9 pin	
Pin	Function	Pin	Function
1-6	DCD5_232	4	DTR5_232
2	RX5_232	3	TX5_232
3	TX5_232	2	RX5_232
4	DTR5_232	1-6	DCD5_232

Table 19.2 Data-I/O cable pinouts (continued)

DB-9 Female 9 Pin		DB-9 Female 9 pin	
Pin	Function	Pin	Function
5	GND	5	GND
7	RTS5_232	8	CTS5_232
8	CTS5_232	7	RTS5_232
9	no connection RI5_232	9	

This data cable may be used for firmware upgrades and other computer functions with the Trimble R8. Power must be supplied to the receiver via Port 1, or from the internal battery.

Note – Table 19.3 gives pinout information for the power/serial data cable, (PN 32345) which is optional for use with the Trimble R8 receiver. This cable can be used for firmware upgrades through Port 1, while also supplying external power.

Note – Table 19.3 assumes that the cable is attached to the connector labeled Port 1.

Table 19.3 Power/serial data cable pinouts

Lemo 0-shell connector 7 Pin		Direction	DE9-F connector 7 Cond			Power lead 2 Cond	
Pin	Function		Pin	Color	Function	Color	Function
1	GND	↔	5	Brown	Signal ground		
2	GND	→				Black	V-OUT
3	TX3_232	→	2	Orange	TXD		
4	RTS/TXD	→	8	Blue	RTS		
5	CTS/RXD	←	7	Green	CTS		
6	PWR_IN	←				Red	Power IN (+)
7	RX3_232	←	3	Yellow	TXD		

SECTION



TRIMBLE R7 AND R8 APPENDIXES

NMEA-0183 Output

In this appendix:

- Introduction
- NMEA-0183 outputs
- Common message elements
- NMEA messages

Introduction

This appendix describes the formats of the subset of NMEA-0183 messages that are available for output by the receivers. For a copy of the NMEA-0183 Standard, visit the National Marine Electronics Association website at www.nmea.org.

NMEA-0183 Outputs

When NMEA-0183 output is enabled, a subset of NMEA-0183 messages can be output to external instruments and equipment connected to the Trimble R7 serial ports. These NMEA-0183 messages let external devices use selected data collected or computed by the GPS receiver.

All messages conform to the NMEA-0183 Version 2.30 format. All begin with \$ and end with a carriage return and a line feed. Data fields follow comma (,) delimiters and are variable in length. Null fields still follow comma (,) delimiters but contain no information.

An asterisk (*) delimiter and checksum value follow the last field of data contained in an NMEA-0183 message. The checksum is the 8-bit exclusive *OR* of all characters in the message, including the commas between fields, but not including the \$ and asterisk delimiters. The hexadecimal result is converted to two ASCII characters (0–9, A–F). The most significant character appears first.

Table A.1 summarizes the set of NMEA messages supported by the Trimble R7 receiver, and shows the page where detailed information about each message can be found.

Table A.1 NMEA message summary

Message	Function	Page
AVR	Time, yaw, tilt, range, mode, PDOP, and number of SVs for Moving Baseline RTK	182
GGA	Time, position, and fix related data	183
GST	Position error statistics	184

Table A.1 NMEA message summary (continued)

Message	Function	Page
GSV	Number of SVs in view, PRN, elevation, azimuth, and SNR	185
HDT	Heading from True North	185
PTNL,GGK	Time, position, position type and DOP values	186
PTNL,GGK_SYNC	Time, synchronized position, position type and DOP values	187
PTNL,PJK	Local coordinate position output	189
PTNL,PJT	Projection type	190
PTNL,VGK	Time, locator vector, type and DOP values	190
PTNL,VHD	Heading Information	191
ROT	Rate of turn	192
VTG	Actual track made good and speed over ground	193
ZDA	UTC day, month, and year, and local time zone offset	194

The output of individual NMEA messages can be enabled or disabled by:

- creating an application file in Configuration Toolbox that contains NMEA output settings, and sending the file to the receiver
- adding NMEA outputs in the *Serial outputs* tab of GPS Configurator, and applying the settings

Common Message Elements

Each message contains:

- A message ID consisting of *\$GP* followed by the message type. For example, the message ID of the GGA message is *\$GPGGA*.
- A comma
- A number of fields that depend on message type, separated by commas
- An asterisk
- A checksum

Below is an example of a simple message with a message ID (*\$GPGGA*), followed by 13 fields and checksum value:

```
$GPGGA,172814.0,3723.46587704,N,12202.26957864,W,2,6,1.2,18.893,M,-25.669,M,2.0,0031*4F
```

Message values

The following values can be found in NMEA messages that the receiver generates.

Latitude and Longitude

Latitude is represented as *ddmm.mmmm* and longitude is represented as *dddmm.mmmm*, where:

- *dd* or *ddd* is degrees
- *mm.mmmm* is minutes and decimal fractions of minutes

Direction

Direction (north, south, east, or west) is represented by a single character: *N*, *S*, *E*, or *W*.

Time

Time values are presented in Universal Time Coordinated (UTC) and are represented as *hhmmss.cc*, where:

- *hh* is hours, from 00 to 23
- *mm* is minutes
- *ss* is seconds
- *cc* is hundredths of seconds

NMEA Messages

When NMEA-0183 output is enabled, the following messages can be generated.

AVR Time, Yaw, Tilt, Range for Moving Baseline RTK

The AVR message string is shown below, and Table A.2 describes the message fields.

```
$PTNL,AVR,181059.6,+149.4688,Yaw,+0.0134,Tilt,,,60.191,3,2.5,6*00
```

Table A.2 AVR message fields

Field	Meaning
1	UTC of vector fix
2	Yaw angle in degrees
3	Yaw
4	Tilt angle in degrees
5	Tilt
6	Reserved
7	Reserved
8	Range in meters
9	Quality indicator: 0: Fix not available or invalid 1: Autonomous GPS fix 2: Differential carrier phase solution RTK (Float) 3: Differential carrier phase solution RTK (Fix) 4: Differential code-based solution, DGPS
10	PDOP
11	Number of satellites used in solution

GGA Time, Position, and Fix Related Data

An example of the GGA message string is shown below. Table A.3 describes the message fields.

```
$GPGGA,172814.0,3723.46587704,N,12202.26957864,W,
2,6,1.2,18.893,M,-25.669,M,2.0,0031*4F
```

Table A.3 GGA message fields

Field	Meaning
1	UTC of position fix
2	Latitude
3	Direction of latitude: N: North S: South
4	Longitude
5	Direction of longitude: E: East W: West
6	GPS Quality indicator: 0: Fix not valid 1: GPS fix 2: Differential GPS fix 4: Real Time Kinematic, fixed integers 5: Real Time Kinematic, float integers
7	Number of SVs in use, range from 00 to 12
8	HDOP
9	Orthometric height (MSL reference)
10	M: unit of measure for height is meters
11	Geoid separation
12	M: geoid separation is measured in meters

Table A.3 GGA message fields (continued)

Field	Meaning
13	Age of differential GPS data record, Type 1 or Type 9. Null field when DGPS is not used.
14	Reference station ID, ranging from 0000 to 1023. A null field when any reference station ID is selected and no corrections are received.

GST Position Error Statistics

An example of the GST message string is shown below. Table A.4 describes the message fields.

```
$GPGST,172814.0,0.006,0.023,0.020,273.6,
0.023,0.020,0.031*6A
```

Table A.4 GST message fields

Field	Meaning
1	UTC of position fix
2	RMS value of the pseudorange residuals (includes carrier phase residuals during periods of RTK(float) and RTK(fixed) processing)
3	Error ellipse semi-major axis 1 sigma error, in meters
4	Error ellipse semi-minor axis 1 sigma error, in meters
5	Error ellipse orientation, degrees from true north
6	Latitude 1 sigma error, in meters
7	Longitude 1 sigma error, in meters
8	Height 1 sigma error, in meters

GSV Satellite Information

The GSV message string identifies the number of SVs in view, the PRN numbers, elevations, azimuths, and SNR values. An example of the GSV message string is shown below. Table A.5 describes the message fields.

```
$GPGSV,4,1,13,02,02,213,,03,-3,000,,
11,00,121,,14,13,172,05*67
```

Table A.5 GSV message fields

Field	Meaning
1	Total number of messages of this type in this cycle
2	Message number
3	Total number of SVs visible
4	SV PRN number
5	Elevation, in degrees, 90° maximum
6	Azimuth, degrees from True North, 000° to 359°
7	SNR, 00–99 dB (null when not tracking)
8–11	Information about second SV, same format as fields 4–7
12–15	Information about third SV, same format as fields 4–7
16–19	Information about fourth SV, same format as fields 4–7

HDT Heading from True North

The HDT string is shown below, and Table A.6 describes the message fields.

```
$GPHDT,123.456,T*00
```

Table A.6 Heading from true north fields

Field	Meaning
1	Heading in degrees
2	T: Indicates heading relative to True North

PTNL,GGK

Time, Position, Position Type, DOP

An example of the PTNL,GGK message string is shown below.
Table A.7 describes the message fields.

```
$PTNL,GGK,172814.00,071296,  
3723.46587704,N,12202.26957864,W,  
3,06,1.7,EHT-6.777,M*48
```

Table A.7 PTNL,GGK message fields

Field	Meaning
1	UTC of position fix
2	Date
3	Latitude
4	Direction of latitude: N: North S: South
5	Longitude
6	Direction of Longitude: E: East W: West
7	GPS Quality indicator: 0: Fix not available or invalid 1: Autonomous GPS fix 2: Differential, floating carrier phase integer-based solution, RTK(float) 3: Differential, fixed carrier phase integer-based solution, RTK(fixed) 4: Differential, code phase only solution (DGPS)
8	Number of satellites in fix
9	DOP of fix

Table A.7 PTNL,GGK message fields (continued)

Field	Meaning
10	Ellipsoidal height of fix
11	M: ellipsoidal height is measured in meters

Note – The PTNL,GGK message is longer than the NMEA-0183 standard of 80 characters.

PTNL,GGK_SYNC

Time, Synchronized Position, Position Type, DOP

The PTNL,GGK_SYNC message has the same format as the PTNL,GGK message, but outputs Synchronized 1 Hz positions even in Low Latency mode. An example of the PTNL,GGK_SYNC message string is shown below. Table A.8 describes the message fields.

```
$PTNL,GGK_SYNC,172814.00,071296,
3723.46587704,N,12202.26957864,W,
3,06,1.7,EHT-6.777,M*48
```

Table A.8 PTNL,GGK_SYNC message fields

Field	Meaning
1	UTC of position fix
2	Date
3	Latitude
4	Direction of latitude: N: North S: South
5	Longitude

Table A.8 PTNL,GGK_SYNC message fields (continued)

Field	Meaning
6	Direction of Longitude: E: East W: West
7	GPS Quality indicator: 0: Fix not available or invalid 1: Autonomous GPS fix 2: Differential, floating carrier phase integer-based solution, RTK(float) 3: Differential, fixed carrier phase integer-based solution, RTK(fixed) 4: Differential, code phase only solution (DGPS)
8	Number of satellites in fix
9	DOP of fix
10	Ellipsoidal height of fix
11	M: ellipsoidal height is measured in meters

Note – The PTNL,GGK_SYNC message is longer than the NMEA-0183 standard of 80 characters.

PTNL,PJK

Local Coordinate Position Output

An example of the PTNL,PJK message string is shown below. Table A.9 describes the message fields.

```
$PTNL,PJK,010717.00,081796,
+732646.511,N,+1731051.091,E,
1,05,2.7,EHT-28.345,M*7C
```

Table A.9 PTNL,PJK message fields

Field	Meaning
1	UTC of position fix
2	Date
3	Northing, in meters
4	Direction of Northing will always be N (North)
5	Easting, in meters
6	Direction of Easting will always be E (East)
7	GPS Quality indicator: 0: Fix not available or invalid 1: Autonomous GPS fix 2: Differential, floating carrier phase integer-based solution, RTK (float) 3: Differential, fixed carrier integer-based solution, RTK (fixed) 4: Differential, code phase only solution (DGPS)
8	Number of satellites in fix
9	DOP of fix
10	Ellipsoidal height of fix
11	M: ellipsoidal height is measured in meters

Note – The PTNL,PJK message is longer than the NMEA-0183 standard of 80 characters.

PTNL,PJT

Projection Type

An example of the PTNL,PJT message string is shown below.
Table A.10 describes the message fields.

```
$PTNL,PJT,NAD83(Conus),California Zone 4 0404,*51
```

Table A.10 PTNL,PJT message fields

Field	Meaning
1	Coordinate system name (can include multiple words)
2	Projection name (can include multiple coordinates)

PTNL,VGK

Vector Information

An example of the PTNL,VGK message string is shown below.
Table A.11 describes the message fields.

```
$PTNL,VGK,160159.00,010997,-0000.161,  
00009.985,-0000.002,3,07,1,4,M*0B
```

Table A.11 PTNL,VGK message fields

Field	Meaning
1	UTC of vector in hhmmss.ss format
2	Date in mmddyy format
3	East component of vector, in meters
4	North component of vector, in meters
5	Up component of vector, in meters

Table A.11 PTNL,VGK message fields (continued)

Field	Meaning
6	GPS quality indicator: 0: Fix not available or invalid 1: Autonomous GPS fix 2: Differential carrier phase solution RTK(float) 3: Differential carrier phase solution RTK(fix) 4: Differential code-based solution, DGPS
7	Number of satellites if fix solution
8	DOP of fix
9	M: Vector components are in meters

PTNL,VHD

Heading Information

An example of the PTNL,VHD message string is shown below. Table A.12 describes the message fields.

```
$PTNL,VHD,030556.00,093098,187.718,  
-22.138,-76.929,-5.015,0.033,0.006,  
3,07,2.4,M*22
```

Table A.12 PTNL,VHD message fields

Field	Meaning
1	UTC of position, in <i>hhmmss.ss,ddmmyy</i> format
2	Date in <i>mmddy</i> format
3	Azimuth
4	Δ Azimuth/ Δ Time
5	Vertical Angle
6	Δ Vertical/ Δ Time
7	Range

Table A.12 PTNL,VHD message fields (continued)

Field	Meaning
8	Δ Range/ Δ Time
9	Quality indicator: 0: Fix not available or invalid 1: Autonomous GPS fix 2: Differential carrier phase solution RTK(float) 3: Differential carrier phase solution RTK(fix) 4: Differential code-based solution, DGPS
10	Number of satellites used in solution
11	PDOP

ROT Rate of Turn

The ROT string is shown below, and Table A.13 describes the message fields.

```
$GPROT,35.6,A*4E
```

Table A.13 ROT message fields

Field	Meaning
1	Rate of turn, degrees/minutes, "-" indicates bow turns to port
2	A: Valid data V: Invalid data

VTG Actual Track Made Good Over and Speed Over Ground

An example of the VTG message string is shown below. Table A.14 describes the message fields.

```
$GPVTG,T,,M,0.00,N,0.00,K*4E
```

Table A.14 VTG message fields

Field	Meaning
1	Track made good (degrees true)
2	T: track made good is relative to true north
3	Track made good (degrees magnetic)
4	M: track made good is relative to magnetic north
5	Speed, in knots
6	N: speed is measured in knots
7	Speed over ground in kilometers/hour (kph)
8	K: speed over ground is measured in kph

ZDA UTC Day, Month, And Year, and Local Time Zone Offset

An example of the ZDA message string is shown below. Table A.15 describes the message fields.

```
$GPZDA,172809,12,07,1996,00,00*45
```

Table A.15 ZDA message fields

Field	Meaning
1	UTC
2	Day, ranging between 01 and 31
3	Month, ranging between 01 and 12
4	Year
5	Local time zone offset from GMT, ranging from 00 to ±13 hours
6	Local time zone offset from GMT, ranging from 00 to 59 minutes

Fields 5 and 6 together yield the total offset. For example, if field 5 is -5 and field 6 is +15, local time is 5 hours and 15 minutes earlier than GMT.

RTCM Output

In this appendix:

- RTCM Output
- Message Scheduling

RTCM Output

Table B.1 shows the messages that are generated when you select a specific RTCM version. The messages in the table are in the same order as they appear in GPS Configurator. For the details of the contents of individual messages, refer to the RTCM documentation.

Table B.1 RTCM output

Selection	Message								
Version 2	1	3			22				59
USCG 9-3		3	9-3						
RTCM/RTK 2.2+2.3	1	3		18	19	22	23	24	59
RTK Only 2.2+2.3		3		18	19	22	23	24	59
RTCM/RTK 2.3	1			18	19		23	24	
RTK Only 2.3				18	19	22			
RTCM/RTK 2.2	1	3		18	19	22			59
RTK Only 2.2		3		18	19	22			59
RTCM/RTK 2.1	1	3		18	19	22			59
RTK Only 2.1		3		18	19	22			59

Message Scheduling

Table B.2 describes the frequency at which messages are generated when they are enabled in a base receiver.

Table B.2 Message scheduling

Type	Frequency
1	Every second
3	The 10th second after the first measurement, then every 10 seconds after that
9-3	Every second
18	Every second
19	Every second
22	The 5th second after the first measurement, then every 10 seconds after that
23	The 4th second after the first measurement, then every 10 seconds after that
24	The 4th second after the first measurement, then every 10 seconds after that
59-sub, 13	The 5th second after the first measurement, then every 10 seconds after that

Troubleshooting

In this appendix:

- LED Conditions
- Receiver Issues

An LED that is flashing quickly indicates a condition that may require attention, and an unlit LED indicates that no operation is occurring. Table C.1 describes some LED conditions, possible causes, and how to solve them.

Table C.1 LED conditions

Condition	Possible cause	Solution
The SV Tracking LED is lit solidly and the Logging/Memory LED is flashing slowly.	The receiver is in Monitor mode, ready for new firmware to be loaded or new options to be added.	Power the receiver off or on. Load the latest version of the firmware, which you can download from www.trimble.com/pub/survey/bin/
The SV Tracking LED is not flashing.	The receiver is tracking fewer than four satellites.	Wait until the SV Tracking LED is flashing slowly.
	The radio antenna cable and GPS antenna cable are mixed up.	Make sure that the GPS antenna cable (with the yellow over-mould) is connected between the yellow TNC connector marked GPS and the GPS antenna.

Table C.2 describes some possible receiver issues, possible causes, and how to solve them.

Table C.2 Receiver issues

Issue	Possible cause	Solution
The receiver does not power up.	External power too low.	Check the charge on the external battery, and check the fuse if applicable. Replace the battery if necessary.
	Internal power too low.	Check the charge on the internal batteries and replace if necessary. Ensure battery contacts are clean.
	External power not properly connected.	Check that the Lemo connection is seated properly. Check for broken or bent pins in the connector.
	Faulty power cable.	Try a different cable. Check pinouts with multimeter to ensure internal wiring is intact.

Table C.2 Receiver issues (continued)



Issue	Possible cause	Solution
Receiver does not log data.	Insufficient memory on the CompactFlash card.	Delete old files using the GPS Configurator or Trimble Survey Controller software, or by holding down  for 30 seconds.
	No CompactFlash card is inserted.	Insert a CompactFlash card in the receiver.
	The CompactFlash card is not seated properly.	Remove the Compact Flash card and reinsert it, making sure that it slides into the housing easily and seats into the pins.
	The receiver is tracking fewer than four satellites.	Wait until the SV Tracking LED is flashing slowly.
	The CompactFlash card is not formatted, or is corrupted.	Format the CompactFlash card using GPS Configurator, or by holding down  for 30 seconds. If the problem persists, use GPS Configurator to perform a full format.
The receiver is not responding.	Receiver needs soft reset.	Power down the receiver and power back up.
	Receiver needs full reset.	Hold down  for 30 seconds. If you want to retain data files, remove the CompactFlash card first.

Table C.2 Receiver issues (continued)



Issue	Possible cause	Solution
Reference receiver is not broadcasting.	Port settings between reference receiver and radio are incorrect.	Using Trimble Survey Controller, connect to the reference radio through the receiver. If no connection is made, connect directly to the radio and change the port settings. Try to connect through the receiver again to ensure that they are communicating.
	Faulty cable between receiver and radio.	<p>Try a different cable.</p> <hr/> <p>Examine the ports for missing pins.</p> <hr/> <p>Use a multimeter to check pinouts.</p>
	No power to radio.	<p>If the radio has its own power supply, check the charge and connections.</p> <hr/> <p>If power is routed through the receiver, ensure that the receiver's external power source is charged and that power output on Port 3 is enabled.</p>

Table C.2 Receiver issues (continued)

Issue	Possible cause	Solution
Roving receiver is not receiving radio.	Reference receiver is not broadcasting.	See above.
	Incorrect over air baud rates between reference and rover.	Connect to the roving receiver's radio and check to ensure it has the same setting as the reference receiver.
	Incorrect port settings between roving external radio and receiver.	If the radio is receiving data (the Logging/Memory LED is flashing) and the receiver is not getting radio communications, use Trimble Survey Controller to check that the port settings are correct.
	The radio antenna cable and GPS antenna cable are mixed up.	Make sure that the radio antenna cable (with the blue over-mould) is connected between the blue TNC connector marked RADIO and the radio antenna.
	The cellular modem does not have hardware flow control enabled.	<p>Disable flow control on the modem.</p> <p>Use a special cable. For more information, refer to the document <i>Using Cellular and CDPD Modems for RTK</i>, which is available from the Trimble website.</p>

Index

Symbols

-  23, 48
-  23, 48, 137
- \$ (NMEA start of message delimiter) 178
- * (NMEA checksum delimiter) 180
- , (NMEA field delimiter) 178
- .cfg files 63–68, 76, 145–148
- .dat files 74, 76
 - size 73
- .elf files 59, 76, 142
- .eph files 76
- .T01 files 73, 74, 76

Numerics

- 1PPS output
 - configuring in real time 116
 - configuring with an application file 117
 - default settings 95
 - enabling in real time 116
 - enabling with an application file 117
 - pulse definition 114
 - time tag definition 115
 - Trimble R7 receiver 18, 92, 114–118

A

- accuracy
 - centimeter-level 18, 122
 - submeter-level 18, 122
- Actual Track Made Good Over and Speed Over Ground message 193
- adding frequencies for internal radio 85, 157
- ANT port 26, 204
- antenna information, default 96, 167
- antenna power adapter 107
- Antenna record, in application file 63, 145
- antennas
 - electrical interference 28, 129
 - mounting 28, 129
 - RPA 38
 - rubber duck 32, 38
 - using with the Trimble R7 receiver 107
 - whip 32, 38
 - Zephyr 33
 - Zephyr Geodetic 33
- application files
 - applying 68, 148
 - configuring the receiver with 145
 - Current (Current.cfg) 64, 94, 146, 166
 - Default (Default.cfg) 64, 94, 146, 166
 - deleting 49, 137
 - deleting by formatting CompactFlash card 54

- editing in Configuration Toolbox
 - software 80, 152
 - maximum number 64, 146
 - naming 68, 148
 - overview 63, 145
 - Power Up (Power_Up.cfg) 65, 94, 147, 166
 - records 63, 145
 - storing 68, 148
 - timed 50, 66, 100
 - using to configure 1PPS output 117
- applying application files 68, 148
- ASCII
 - output, default settings 95, 167
 - time tags, default 95
 - time tags, definition 115
- B**
- backpack setup 38
- base station *See* reference station
- baseline, moving 178
- batteries
 - camcorder 43
 - charging in reference and rover
 - receiver at the same time 56
 - charging while in Trimble R7
 - receiver 55
 - charging with TSCe/TSC1
 - batteries 57
 - minimum power to charge 56
 - operating time 54, 90, 162
 - standby 51
- battery
 - compartments 24, 27, 129
 - inserting in the Trimble R8
 - receiver 130
- Battery LEDs 51
- baud rate
 - default 95, 167
 - maximum 92, 164
- binary output, default settings 95, 167
- blue RPA cable 26, 204
- blue TNC port 26, 204
- Bluetooth 3
- bottom panel 27, 129
- bracket
 - insert 34
 - receiver 34, 35
 - RPA 32
- breakout box, on event marker/1PPS
 - cable 105
- buttons 23, 48, 126, 137
- C**
- cables
 - coaxial 107
 - data/power 71, 104, 172
 - event marker/1PPS 105
 - GPS antenna 26, 115
 - RPA 26
- camcorder batteries 43
- catch
 - for battery compartment 24
 - for CompactFlash/USB door 23, 126
- cellphones 43, 132
- cellular modems 43, 132, 204
- centimeter-level accuracy 18, 122
- charging
 - internal batteries 55
 - minimum time required 56
 - Trimble R7 and TSC1/TSCe
 - batteries 57
- CMR
 - input 19, 123
 - output 19, 123
 - output, default settings 95
- coaxial cable, for connecting to GPS
 - antenna 107

- COCOM limits 20, 124
 - cold start, time required 92, 164
 - color-coded TNC ports 26
 - CompactFlash card
 - corrupted 202
 - formatting 49, 54, 202
 - full 52
 - logging data to 52
 - transferring files from 74
 - Type I 46
 - upgrading receiver firmware from 59, 142
 - CompactFlash port 27, 129
 - CompactFlash/USB door 27, 129
 - CompactFlash/USB door catch 23, 126
 - Configuration Toolbox software
 - configuring 1PPS output 117
 - configuring event marker input 112
 - configuring the receiver with 144, 148
 - description 80, 152
 - editing application files 80, 152
 - installing 80, 152
 - storing application files 68
 - configuring
 - 1PPS output in real time 116
 - 1PPS output with an application file 117
 - event marker input in real time 110
 - MS Series parameters 182
 - multiple receivers identically 148
 - receiver in real time 62, 144
 - receiver using application files 145
 - connecting to computer for data transfer 71
 - controller
 - mounting on pole 36
 - power supply 57
 - setup 36
 - corrupted CompactFlash card 202
 - creating application files 80, 152
 - Current application file 64, 94, 146, 166
 - current receiver configuration 146
 - current settings 166
 - Current.cfg 64, 94, 146, 166
- ## D
- DAT files 73, 74
 - data
 - logging internally 52
 - logging to Trimble Survey Controller 53, 140
 - transferring from the receiver 69
 - Data button 23, 48
 - data files
 - deleting by formatting CompactFlash card 54
 - transferring from CompactFlash card 74
 - Trimble R7 receiver 74, 76
 - Data LED *See* Logging/Memory LED
 - data link, using a cellular modem 43, 132
 - data outputs, NMEA 182
 - data storage cards *See* CompactFlash cards
 - data transfer
 - transferring files 69–76
 - with serial connection 71
 - with USB connection 72
 - Data Transfer utility
 - deleting files on receiver with 76
 - transferring files with 73
 - data/power cable pinouts 104, 172, 173
 - Default application file 64, 94, 146, 166
 - default settings
 - 1PPS time tags 95
 - antenna 96, 167
 - ASCII output 95, 167
 - ASCII time tags 95
 - baud rate 95, 167

- binary output 95, 167
 - changing 147
 - CMR output 95
 - elevation mask 95, 167
 - logging rate 96
 - measurement rate 96
 - motion 95, 167
 - NMEA output 95, 167
 - overriding 146
 - Port 3 power output 95
 - position logging rate 96
 - reference position 96, 167
 - reference station 95, 167
 - resetting 140
 - RT17 output 95, 167
 - RTCM output 95
 - serial format 95, 167
 - SNR mask 95, 167
 - streamed output 95, 167
 - SV enabling 95, 167
 - Trimble R7 receiver 94
 - Trimble R8 receiver 166
 - Default.cfg 64, 94, 146, 166
 - deleting files
 - application files 49, 137
 - by formatting CompactFlash card 54
 - ephemeris file 49, 137
 - in the receiver 76
 - delimiters, NMEA
 - checksum 180
 - field separator 180
 - start of message 178
 - Device Control record, in application file 63, 145
 - diameter, of pole 34
 - dimensions
 - Trimble R7 receiver 90
 - Trimble R8 receiver 162
 - direction, NMEA field format 180
 - disabling flow control 204
 - dual event marker input 18, 110
 - dual-frequency RTK engine 18, 122
- ## E
- editing application files 80, 152
 - electrical interference 28, 129
 - electronic interference 124
 - elevation mask
 - default 95, 167
 - enabling
 - 1PPS output in real time 116
 - 1PPS output with an application file 117
 - event marker input in real time 110
 - event marker input with an application file 112
 - power output on Port 3 58, 142
 - enhanced RTK *See* extended RTK
 - environmental factors
 - when setting up the receiver 28, 129
 - ephemeris file
 - deleting 49, 137
 - supported file type 76
 - eRTK Range Pole antenna *See* RPA
 - event marker input
 - configuring in real time 110
 - configuring with an application file 112
 - feature 18
 - Event Marker LED *See* Radio LED
 - event marker/1PPS
 - cable 105
 - cable pinouts 106
 - examples, of default behavior 97
 - extended RTK 18
 - external power 58
 - minimum required to charge internal batteries 56

F

factory defaults

- resetting to 49, 96, 137, 168
- Trimble R7 receiver 93–100
- Trimble R8 receiver 165–168

FastStatic surveying

- specifications 91, 163

features

- 1PPS output 18
- automatic OTF (on-the-fly)
 - initialization 18, 122
- centimeter accuracy 18, 122
- charging batteries internally 19
- CMR input and output 19, 123
- CompactFlash card 18
- extended RTK 18
- OTF data 18, 122
- real-time positioning 18, 122
- RS-232 ports 19
- RTCM SC-104 input and output 19, 123
- RTK data 18, 122
- submeter accuracy 18, 122
- Trimble R8 receiver 122
- USB port 18
- WAAS capability 18, 122

file size 73

File Storage record, in application file 63, 145

file types

- .cfg 76
- .dat 74
- .elf 76
- .eph 76
- .T01 74
- application (.cfg) 76
- DAT 73
- data (.dat) 74
- data files 74

- ephemeris (.eph) 76
- job 53, 140
- raw observations (.T01) 76
- receiver firmware (.elf) 76
- supported 76

files

- deleting 76
- transferring from CompactFlash card 74

firmware

- (.elf) files 76
- upgrading 59, 83, 142, 155

flashing LED 49, 137

flow control

- default setting 95, 167
- disabling on cellular modem 43, 133, 204
- Trimble R7 receiver 92
- Trimble R8 receiver 164

formatting a CompactFlash card 46, 49, 54

frequencies, for internal radio 85, 157

front panel 23, 126

full format 202

full memory 52

full reset 202

G

General Controls record, in application file 63, 145

GGA message, time, position, and fix related data 182

GPS antenna cable 26

GPS antenna port 19, 26, 123, 204

GPS Configurator software

- configuring 1PPS output 116
- configuring event marker input 110
- configuring Trimble R7 receiver 79
- configuring Trimble R8 receiver 151

- deleting files on receiver with 76
- installing 78, 150
- performing a full format 202
- Trimble R7 receiver 53, 78
- Trimble R8 receiver 132, 144, 150

GPS LED *See* SV Tracking LED

green LEDs 51

GSOF output 92

GST message 184

GSV message 185

guidelines for setting up receiver 29, 130

H

Heading Information message 191

I

icons, on top panel 26, 128

indicator LEDs 23, 49, 126, 137

initialization

- minimum time required 92, 164
- on-the-fly 18, 122
- specifications 92, 164

input

- CMR 19, 123
- event marker 18, 109
- RTCM 19, 123

Input Message record, in application file 63, 145

insert, for receiver bracket 34

installing

- Configuration Toolbox software 80, 152
- GPS Configurator software 78, 150
- WinFLASH software 83, 155

interference

- electrical 28, 129
- electronic 124

internal batteries

- charging 19
- charging while in Trimble R7 receiver 55
- charging with TSC1/TSCe batteries 57
- minimum power to charge 56
- operating time 54, 90, 162
- standby 51

internal radio

- adding frequencies 85, 157
- Trimble R7 receiver 41
- Trimble R8 receiver 132

J

job files 53, 140

L

latency of Trimble R7 receiver 91

latency of Trimble R8 receiver 163

latitude, NMEA field format 180

LEDs

- Battery 1 51
- Battery 2 51
- flashing 49, 137
- Logging/Memory 50
- Radio 51
- SV Tracking 50
- Trimble R7 receiver 23, 49
- Trimble R8 receiver 126, 137

Lemo cables, plugging in 29, 130

limits, imposed by COCOM 20, 124

Lithium ion batteries, voltage 59

Local Coordinate Position Output message 189

logging

- internally 52

- scheduling 66
- starting 49
- stopping 49
- to Trimble Survey Controller software 53, 140
- Logging button *See* Data button
- Logging Rate record, in application file 63, 145
- logging rate, default 96
- Logging/Memory LED 50
- longitude, NMEA field format 180
- Low Latency RTK mode, specifications 91, 163

M

- maximum
 - baud rate 92, 164
 - number of application files 64, 146
- Maxwell architecture 92, 164
- measurement rate, default 96
- Memory LED *See* Logging/Memory LED
- memory, full 52, 202
- message ID, in NMEA messages 180
- mobile phones 43, 132
- Monitor mode 50, 59, 142, 200
- motion, default settings 95, 167
- mounting antenna, avoiding electrical interference 28, 129
- multiple receivers, configuring identically 148

N

- naming application files 68, 148
- NMEA
 - output 19, 123, 177–194
 - output, default settings 95, 167

- NMEA messages
 - common elements 179
 - common message elements 180
 - delimiters 180
 - enabling and disabling 179
 - GGA 183
 - GST 184
 - GSV 185
 - ID 180
 - PTNL,GGK 186
 - PTNL,GGK_SYNC 187
 - PTNL,PJK 189
 - PTNL,PJT 190
 - PTNL,VGK 190
 - PTNL,VHD 191
 - summary 178
 - values 180
 - VTG 193
 - ZDA 194
- NMEA-0183 output 178

O

- One Pulse per Second output *See* 1PPS output
- on-the-fly (OTF) initialization 18, 122
- operating controls 126
- operating temperature 27, 90, 162
- OTF initialization *See* on-the-fly initialization
- output formats
 - 1PPS 18, 92, 109
 - CMR 19, 123
 - GSOFF 92
 - NMEA 19, 123, 177
 - RT17 92, 95, 164, 167
 - RTCM 19, 123
 - Trimble R7 receiver 92
 - Trimble R8 receiver 164

Output Message record, in application
file 63, 145
overriding default settings 146

P

parts of the receiver 22–27
physical specifications 90, 162
pinout information 170
pinouts
 data/power cable 104, 172, 173
 event marker/1PPS cable 106
 serial ports 103, 171

pole diameter 34

pole-mounted setup

 pole diameter 34
 Trimble R7 receiver 32
 Trimble R8 receiver 130
 TSC1/TSCe controller 36

Port 1

 connector pin locations 103
 default baud rate 95, 167
 default serial format 95, 167
 event marker input 110
 flow control 95, 167
 icon 26, 128
 pinout diagram 103, 171
 pinout functions 103
 power output 58, 142

Port 2

 1PPS output 110
 connector pin locations 103
 default baud rate 95, 167
 default serial format 95, 167
 event marker input 110
 icon 26, 128
 pinout diagram 103, 171
 pinout functions 103

Port 3

 connector pin locations 103
 default baud rate 95
 default power output 95
 default serial format 95
 flow control 95, 167
 icon 26
 pinout diagram 103, 171
 pinout functions 103
 power output 58, 59, 142

port settings, checking 204

Position Error Statistics message 184

position logging rate, default 96

positioning specifications 91, 163

postprocessed setup 30

power

 external 58
 minimum to charge batteries 56

Power button 23, 48, 137

power cable, pinouts 104, 172, 173

Power LEDs *See* Battery LEDs

power output

 automatically enabling on Port 3 59
 enabling on Port 3 58, 142
 on Port 1 58, 142

power source 140

power supply 55

Power Up application file

 overriding factory defaults with 94,
 166

 Trimble R7 receiver 65

 Trimble R8 receiver 147

power/data ports 25

Power_Up.cfg

 overriding factory defaults with 94,
 166

 Trimble R7 receiver 65

 Trimble R8 receiver 147

powering down the receiver 49, 137

powering up the receiver 49, 51, 137, 138

problems, troubleshooting 199–200
 Projection Type message 190
 PTNL,GGK message 186
 PTNL,GGK message, Time, Position,
 Position Type, DOP 185
 PTNL,GGK_SYNC message 187
 PTNL,PJK message 189
 PTNL,PJT message 190
 PTNL,VGK message 190
 PTNL,VHD message 191
 pulse, for 1PPS output 114

Q

quick format 46, 53, 202

R

radio antenna port 19, 26, 123, 204
 Radio LED 51
 RADIO port
 icon 26, 128
 Trimble R7 receiver 26
 troubleshooting 204
 radio-modems, using 3
 radios
 internal 41, 132
 Trimble R7 receiver 40
 Trimble R8 receiver 131
 TRIMMARK 3 40, 132
 TRIMMARK IIe 40, 132
 TRIMTALK 450S 40, 132
 Range Pole antenna *See* RPA
 raw observations 76
 real time, configuring receiver in 62, 144
 rear panel 24, 127
 receiver
 bracket 34, 35
 catch lock 24, 127

 changing default settings 147
 configuring 144
 connecting to devices 170
 current configuration 146
 data files 74
 firmware files 76
 resetting 146
 receiver setup 21–46, 125–133
 receivers, multiple
 configuring identically 148
 red LED 50
 Reference Position record, in application
 file 63, 145
 reference position, default 96, 167
 reference receiver, charging batteries 56
 reference station
 default 95, 167
 default settings 95, 167
 reformatting CompactFlash card 54
 registration 14
 release notes 14
 reset
 full 202
 soft 202
 to factory defaults 49, 96, 137, 168
 Trimble R8 receiver 146
 rover, charging batteries 56
 RPA 38
 RPA bracket 32
 RS-232 ports 19
 RT17 output
 default settings 95, 167
 Trimble R7 receiver 92
 Trimble R8 receiver 164
 RTCM input 19, 123
 RTCM output
 default settings 95
 messages 196
 Trimble R7 receiver 19
 Trimble R8 receiver 123

RTK engine 18, 122
RTK/OTF data 18, 122
rubber duck antenna 32, 38

S

safety 4
Satellite Information message 185
Satellite LED *See* SV Tracking LED
scheduling logging sessions 66
security limits 124
serial format, default setting 95, 167
Serial Port Baud/Format record, in
 application file 63, 145
serial ports
 pinouts 103, 172
 Trimble R7 receiver 18, 19, 25
setup
 backpack 38
 guidelines 28, 129
 pole-mounted 32, 130
 postprocessed survey 30
 Trimble R7 receiver 21–46
 Trimble R8 receiver 125–133
 TSC1/TSCe controller 36
signal processing 92, 164
size
 Trimble R7 receiver 90
 Trimble R8 receiver 162
Sleep mode 50, 100
SNR mask, default setting 95, 167
soft reset 202
specifications
 physical 90, 162
 positioning 91, 163
 technical 92, 164
 Trimble R7 receiver 89–92
 Trimble R8 receiver 161–164
standby, battery 51
starting logging manually 49

start-up specifications 92, 164
Static surveying
 specifications 91, 163
Static/Kinematic record, in application
 file 63, 145
stopping logging manually 49
storage temperature 27, 90, 162
storing application files 68, 148
streamed output, default settings 95, 167
submeter-level accuracy 18, 122
supported file types 76
Survey Controller software *See* Trimble
 Survey Controller software
SV Enable/Disable record, in application
 file 63, 145
SV enabling, default settings 95, 167
SV Tracking LED 50
switching the receiver on and off 49, 51,
 137, 138
Synchronized RTK mode, specifications 91,
 163

T

technical specifications 92, 164
temperature
 operating range 27, 90, 162
 storage range 27, 90, 162
time tag definition 115
time values in NMEA messages 181
Time, Position, and Fix Related Data
 message 183
Time, Position, and Fix Related Data, GGA
 message 182
Time, Position, Position Type, DOP
 message 186
Time, Synchronized Position, Position Type,
 DOP message 187
Timed Activation record, in application
 file 63

-
- timed application files 50, 66, 100
 - TNC connector 19, 107, 123
 - TNC ports 19, 123
 - top panel 25
 - tracking specifications 92, 164
 - transferring
 - data files from CompactFlash card 74
 - data files from the receiver 69
 - Trimble Binary Streamed Output *See* GSOF output
 - Trimble Format (CMR) *See* CMR format
 - Trimble R7 receiver
 - backpack setup 38
 - buttons 48
 - factory default settings 94
 - features 18
 - internal radio 41
 - LEDs 49
 - maximum number of application files 64
 - output formats 92
 - parts of the receiver 22–27
 - pole-mounted setup 32
 - postprocessed setup 30
 - resetting to factory defaults 49, 96
 - setup 21–46
 - specifications 89–92
 - turning on and off 49, 51
 - upgrading firmware 59, 83
 - use and care 19
 - Trimble R8 receiver
 - buttons 137
 - factory default settings 166
 - inserting the internal battery 130
 - internal radio 132
 - LEDs 137
 - maximum number of application files 146
 - output formats 164
 - parts of the receiver 126–128
 - pole-mounted setup 130
 - resetting to factory defaults 137, 168
 - setup 125–133
 - specifications 161–164
 - turning on and off 137, 138
 - upgrading firmware 142, 155
 - use and care 124
 - Trimble Survey Controller software
 - automatically enabling power output 59
 - configuring the internal radio with 132
 - configuring the receiver with 144
 - logging data to 53
 - Trimble web site 13, 44, 133
 - TRIMMARK 3 radio 40, 132
 - TRIMMARK IIe radio 40, 132
 - TRIMTALK radio 40, 132
 - troubleshooting 199–200
 - TSC1/TSCe controller
 - deleting files on receiver with 76
 - mounting on pole 36
 - power supply 57
 - setup 36
 - turning the receiver on and off 49, 51, 137, 138
 - Type approval 4
 - Type I CompactFlash cards 18, 46
 - types of files supported 76
- ## U
- U.S. Department of Commerce 20, 124
 - Universal Time Coordinated (UTC) *See* UTC
 - upgrading receiver firmware 59, 83, 142, 155
 - USB cable, connecting for data transfer 72
 - USB port 18, 27, 92, 129
 - use and care of Trimble R7 receiver 19

Index

use and care of Trimble R8 receiver 124
UTC Day, Month, and Year, and Local Time
 Zone Offset message 194
UTC, NMEA time values 181

V

Vector Information message 190
voltage
 minimum required to charge internal
 batteries 56
 of internal batteries 59
VTG message 193

W

WAAS
 specifications 91, 163
 Trimble R7 receiver 18
 Trimble R8 receiver 122
waking up, from Sleep mode 67
warm start, time required 92, 164
web site 13, 44, 133
weight
 Trimble R7 receiver 90
 Trimble R8 receiver 162
whip antenna 32
WinFLASH software
 installing 83, 155
 Trimble R7 receiver 83
 Trimble R8 receiver 132, 155
 upgrading receiver firmware with 83,
 155
world wide web site 13, 44, 133

Y

yellow GPS antenna cable 26, 204
yellow LEDs 50, 51
yellow TNC port 26, 204

Z

ZDA message 194
Zephyr antenna 33
Zephyr Geodetic antenna 33